

# STRA 2.0

The Stra family of in-grades uplights are robust and powerful. With an IP69K rating (making them suitable for power washing) along with an optional IP68 housing, these fixtures are durable. Various optics and static white available. RGBW available on the Stra 5.0.

## TECHNICAL DATA

<b>Wattage / Input</b>	25W (120-277VAC)
<b>Power Supply</b>	Integral
<b>Construction</b>	Body: Aluminum Alloy EN AB 47100 Trim: AISI 316L Stainless Steel Lens: Extra-clear Tempered Glass
<b>CCT</b>	2700K, 3000K, 4000K (3500K available, consult factory)
<b>CRI</b>	CRI >80, >90
<b>BUG Rating</b>	B2-U0-G0 (3000K, CRI80, V, S, M, L, W) B2-U0-G0 (3000K, CRI90, V, S, M) B1-U0-G0 (3000K, CRI90, L, W)
<b>Delivered Lumens</b>	1350 lm (3000K, 30°, CRI 80) 1080 lm (3000K, 30°, CRI 90)
<b>Efficacy</b>	54 lm/W (3000K, 30°, CRI 80) 43 lm/W (3000K, 30°, CRI 90)
<b>Optics</b>	5 Standard (see below)
<b>Finishes</b>	Micro-Blasted Stainless Steel
<b>Fixture Dimensions</b>	Ø11.42" x 5.43" h
<b>Aperture</b>	Ø7.13"
<b>Fixture Weight</b>	11.02 lbs
<b>LED Source</b>	4 High-Intensity Power LEDs
<b>Lumen Maintenance</b>	L85,B10>50,000hrs (Ta 25°C)
<b>Color Consistency</b>	3-Step MacAdam
<b>Operating Temp.</b>	-4°F to +113°F
<b>IP Rating</b>	IP69, IP68 with purpose-built outer casing
<b>IK Rating</b>	IK10



Fixture Dimensions

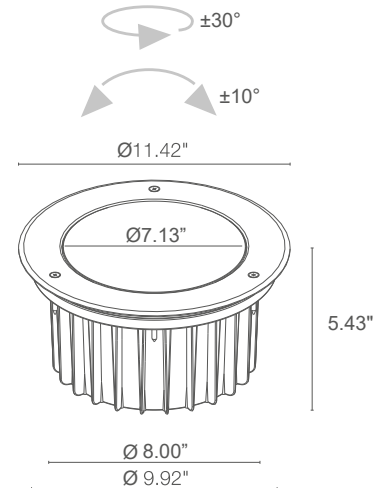

## ORDERING INFORMATION

Example: CS2010FMI. Accessories ordered separately.

CS2010				I
Model No.	CRI	CCT	Optics	Finish / Dimming
CS2010	0 - 80 CRI 1 - 90 CRI	F - 2700K 5 - 3000K 9 - 4000K	V - 11° tiltable S - 14° tiltable M - 30° tiltable L - 37° tiltable W - 10° x 45° tiltable	I - Stainless Steel / Non-Dim

Job Name/Date:

Fixture Type Designation:

## ACCESSORIES

### Anti-Glare

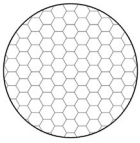

#### WH0610

Honeycomb Louvre  
*Not available for 66°x11°  
and wall washer optics*

## ACCESSORIES

### Installation

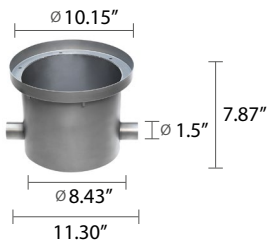

**WC5611-US**  
Outer Casing  
IP68



**WE0202**  
Tamper-resistant  
screw kit



**WE0203**  
Screwdriver for tamper  
resistant screws



**WN7001**  
Pair of extractors  
for outer casings

Job Name/Date:

Fixture Type Designation:

## PHOTOMETRIC DATA

Note all Photometry is CRI 80, 3000K

### V - 11° CRI 80 (Stra 1.0 - 2.0 - 3.0)

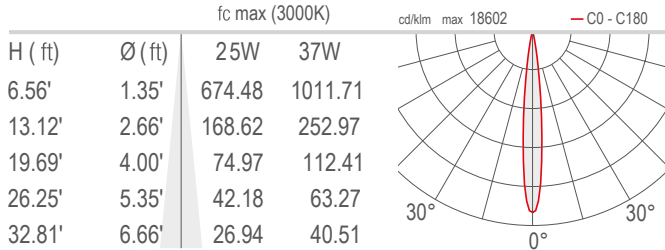

### S - 14° CRI 80

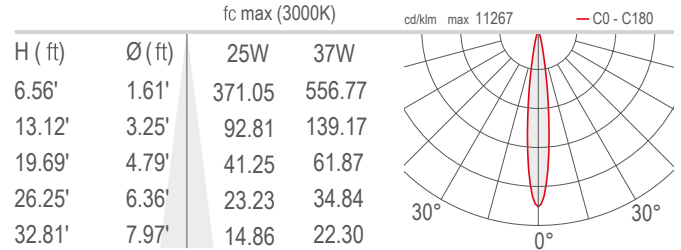

### M - 30° CRI 80

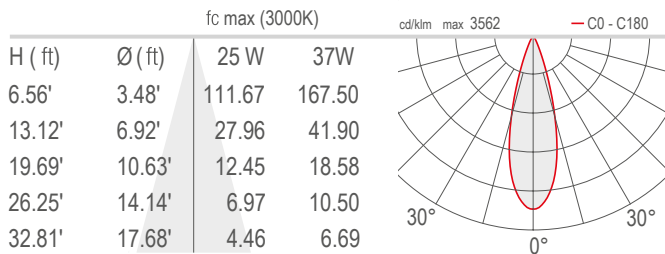

### L - 37° CRI 80

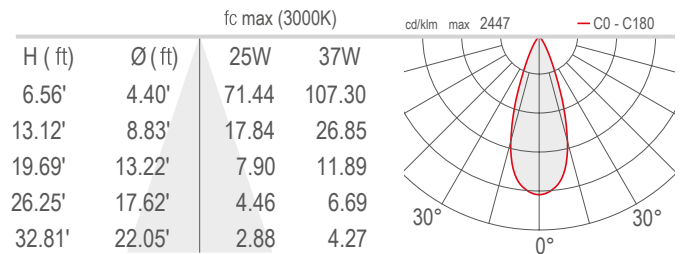

### W - 10°x45° CRI 80

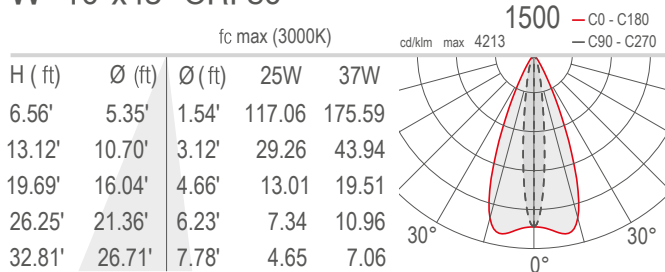

Job Name/Date:

Fixture Type Designation: