

The Stra family of in-grades uplights are robust and powerful. With an IP69 rating (making them suitable for power washing) along with an optional IP68 housing, these fixtures are durable. Various optics and static white available. RGBW available on the Stra 5.0.

TECHNICAL DATA

Wattage / Input	25W (120VAC)
Power Supply	Integral
Construction	Body: Aluminum Alloy EN AB 47100 Trim: AISI 316L Stainless Steel Lens: Extra-clear Tempered Glass
CCT	2700K, 3000K, 4000K <i>(3500K available, consult factory)</i>
CRI	CRI >80, >90
Delivered Lumens	1395 lm (3000K, 30°, CRI 80) 1116 lm (3000K, 30°, CRI 90)
Efficacy	56 lm/W (3000K, 30°, CRI 80) 45 lm/W (3000K, 30°, CRI 90)
Optics	4 Standard (see below) Adjustable ±10° in all directions, infrared remote control required.
Finishes	Micro-Blasted Stainless Steel
Fixture Dimensions	Ø11.42" x 5.43"
Aperture	Ø7.13"
Fixture Weight	11.02 lbs
LED Source	4 High-Intensity Power LEDs
Lumen Maintenance	L85,B10>50,000hrs (Ta 25°C)
Color Consistency	3-Step MacAdam
Operating Temp.	-4°F to +113°F
IP Rating	IP69, IP68 with purpose-built outer casing
IK Rating	IK10



Fixture Dimensions

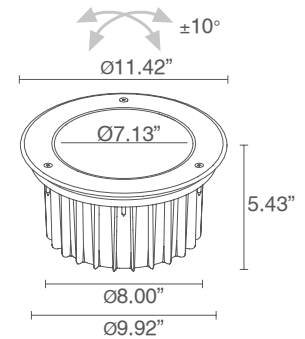

ORDERING INFORMATION

Example: CS40100FMI. Accessories ordered separately.

CS4010				I
Model No.	CRI	CCT	Optics	Finish / Dimming
CS4010	0 - 80 CRI 1 - 90 CRI	F - 2700K 5 - 3000K 9 - 4000K	S - 14° M - 30° L - 37° W - 10° x 45°	I - Stainless Steel / Non-Dim

Job Name/Date:

Fixture Type Designation:

ACCESSORIES

Anti-Glare

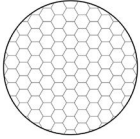

WH0610

Honeycomb Louvre
*Not available for 66"x11"
and wall washer optics*

ACCESSORIES

Installation

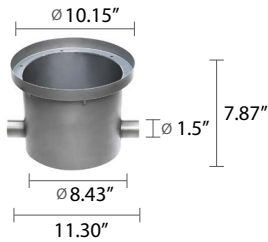

WC5611-US

Outer Casing
IP68



WE0202

Tamper-resistant
screw kit



WE0203

Screwdriver for tamper
resistant screws



WN7001

Pair of extractors
for outer casings



TLC07

Infrared Remote Control
(Required, Stra 4.0)

Job Name/Date:

Fixture Type Designation:

PHOTOMETRIC DATA

Note all Photometry is CRI 80, 3000K

V - 11° CRI 80 (Stra 1.0 - 2.0 - 3.0)

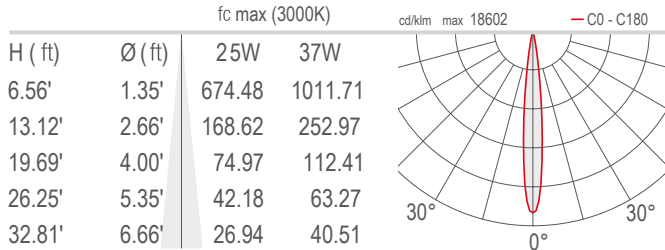

S - 14° CRI 80

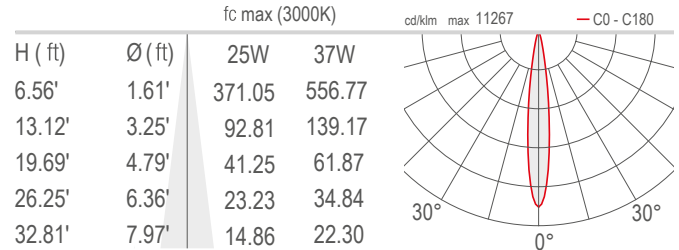

M - 30° CRI 80

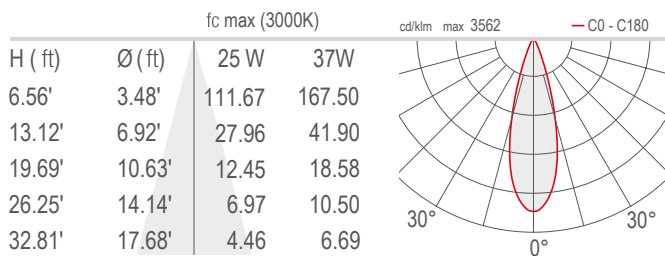

L - 37° CRI 80

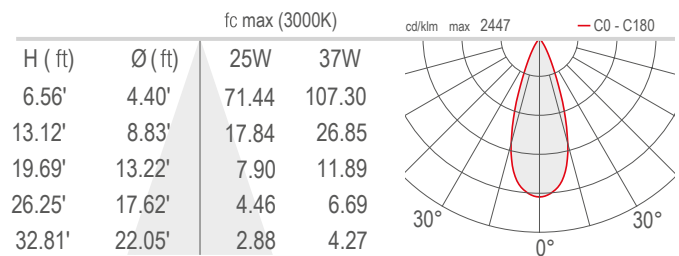

W - 10°x45° CRI 80

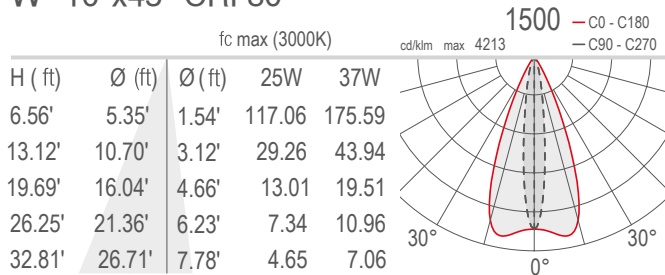

Job Name/Date:

Fixture Type Designation: