

TAGO 1.0, 1.1, 1.3

Tago is an adjustable, driveover-rated, linear profile that is suitable for architectural lighting of facades of historic and public buildings, hotels and residential exteriors. It is available in 3 lengths with a wide range of optics and 4 color temperatures. Tago 1 series is the recessed version with regressed frame.



TECHNICAL DATA

Wattage	14W, 24W, 51W
Power Supply	Integral 120-277VAC (0-10V Dimming)
Construction	Body: Anodized Anticorodal Aluminum Caps: Technopolymer Lens: Tempered, Serigraphed & Extra-Clear Glass Cable Length: 2 x 4.92'
CCT	2200K, 2700K, 3000K, 4000K
CRI	80
BUG Rating	B1-U1-G0 (Tago 1.0 - LN Optic 29°) B2-U1-G0 (Tago 1.1 - LN Optic 29°) B3-U1-G0 (Tago 1.3 - LN Optic 29°)
Delivered Lumens	See Chart on page 2.
Efficacy	See Chart on page 2
Optics	7 Adjustable Available, see below
Finishes	Anodized Black (4 Stage Marine Grade Finish)
Fixture Dimensions	See Chart on page 2.
Fixture Weight	See Chart on page 2.
Lumen Maintenance	L80, B10>60,000hrs
Color Consistency	2-Step MacAdam, 3-Step MacAdam (2200K)
Operating Temp.	-4°F to +113°F
IP Rating	IP65, IP67, IP69
Impact Rating	IK09
Driveover Capacity	Up to 4409 lbs

ORDERING INFORMATION

Example: TG10100201N0SN. Accessories ordered separately.

Model No.	Optical Accessories	CCT	Optics
TG101002 - Tago 1.0 (14W)	00 - None	N0 - 2200K	SN - 11° adjustable ±20°
TG111002 - Tago 1.1 (24W)	01 - Honeycomb Louvre*	F0 - 2700K	MN - 17° adjustable ±20°
TG131002 - Tago 1.3 (51W)	02 - Anti-Glare Shield**	50 - 3000K	LN - 29° adjustable ±20°
	NOTE: *Honeycomb Louvre only available on the 29°, 69°, and 20°x49° optics.	90 - 4000K	KN - 69° adjustable ±20°
	**Anti-Glare Shield only available on the 17°, 29°, 69°, and 20°x49° optics.		WN - 20°x49° adjustable ±20°
			GN - Wall Grazing adjustable ±20°
			AN - Wall Washer adjustable ±20°

Job Name/Date:

Fixture Type Designation:

TECHNICAL DATA

	TAGO 1.0	TAGO 1.1	TAGO 1.3
Wattage	14W	24W	51W
Delivered Lumens (3000K)	932 lm (29°)	1864 lm (29°)	3728 lm (29°)
Efficacy	66.6 lm/W	77.7 lm/W	73.1 lm/W
Fixture Dim. (l,w,h)	12.68" x 3.23" x 4.65"	22.52" x 3.23" x 4.65"	42.20" x 3.23" x 4.65"
Alum. Outer Casing Dim. (l,w,h)	12.32" x 2.48" x 5.91"	19.80" x 2.48" x 5.91"	41.85" x 2.48" x 5.91"
Fixture Weight	2.9 lbs	4.6 lbs	9.0 lbs
LED Source	12 SMD LEDs, spacing 0.82"	24 SMD LEDs, spacing 0.82"	48 power LEDs, spacing 0.82"

FIXTURE DIMENSIONS

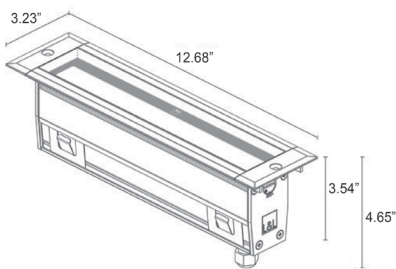

TAGO 1.0

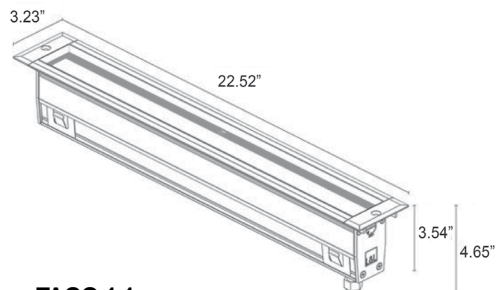

TAGO 1.1

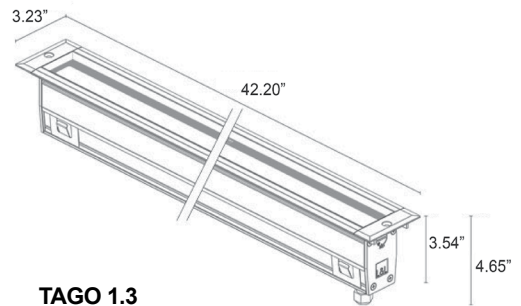

TAGO 1.3

ADJUSTABILITY & ANTI-GLARE FEATURES

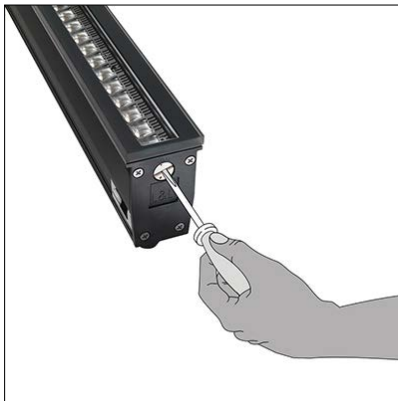

Tilting system is inside the optical unit. The light direction can be altered by $\pm 20^\circ$ externally with a simple adjustment on the end caps, without compromising the fixture's IP65 or IP67 protection level.

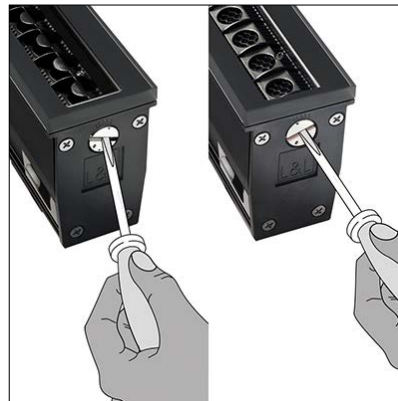

The honeycomb louvre or anti-glare shield, which can be ordered at the same time as the fixture, is mounted on the optical unit, so that the chosen option tilts together with the optics providing anti-glare solutions.

Job Name/Date:

Fixture Type Designation:

ACCESSORIES - Installation

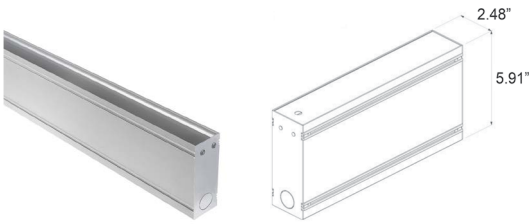

WCTG10A0T - Tago 1.0 (12.32")
WCTG11A0T - Tago 1.1 (22.17")
WCTG13A0T - Tago 1.3 (41.85")
Outer Casing

Wiring Materials



WFA0005
16.40' 4-pin interconnect cable
required when daisy-chaining fixtures that are more than 4.9 ft apart

***WFA04 & WFA0005
must be ordered together**



WFA0101
4.92' 4-Pin Interconnect Cable
required when daisy-chaining fixtures that are more than 4.9 ft apart



WFA02 - Included
IP68 'H' Type Three-Way Connector
4-Pin (3.23" x 2.10" x 1.10")
For IP68 in/out connection



WFA03-US - REQUIRED, Not Included
3-Pin Female Connector
For IP66-IP68 in/out connection



WFA04-US
3-Pin Male Connector
required when daisy-chaining fixtures that are more than 4.9 ft apart
For IP66-IP68 in/out connection

Job Name/Date:

Fixture Type Designation:

PHOTOMETRIC DATA

Note: all Photometry is 3000K

TAGO 1.0

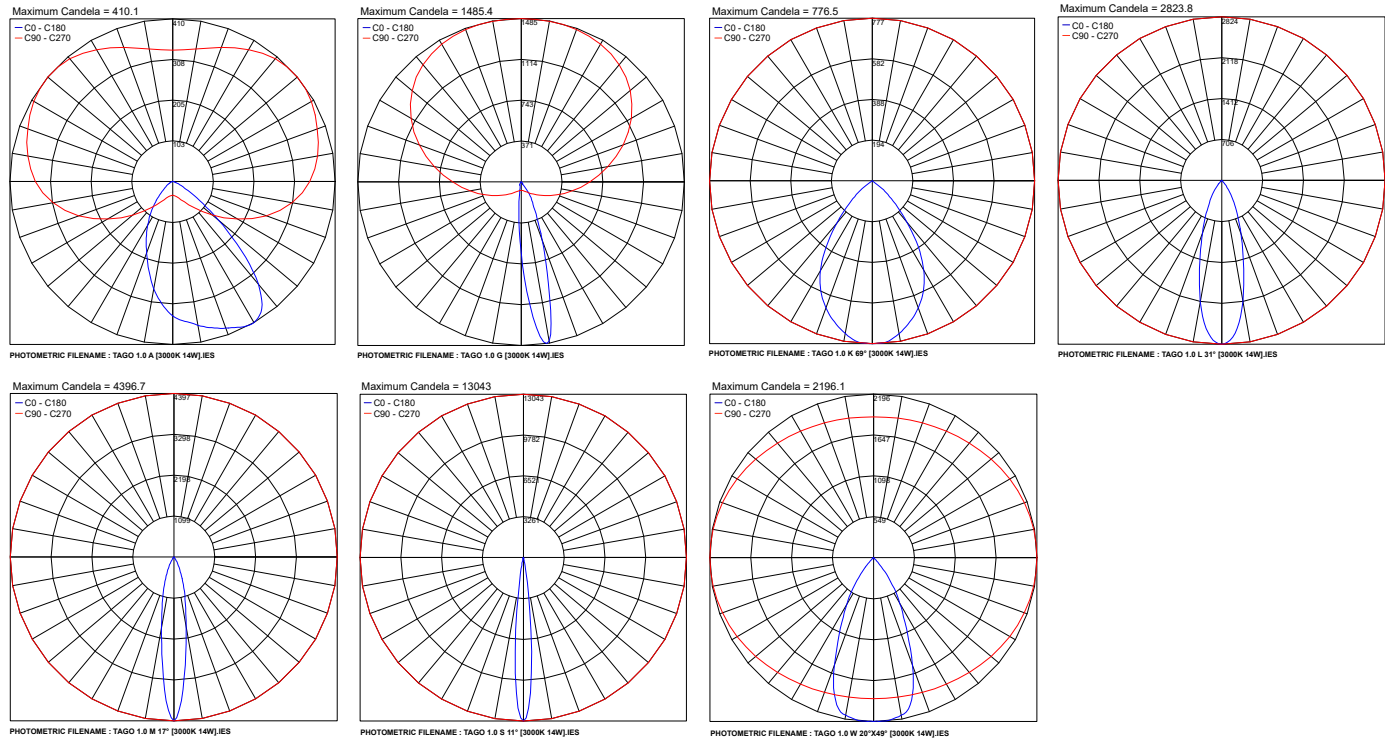

TAGO 1.1

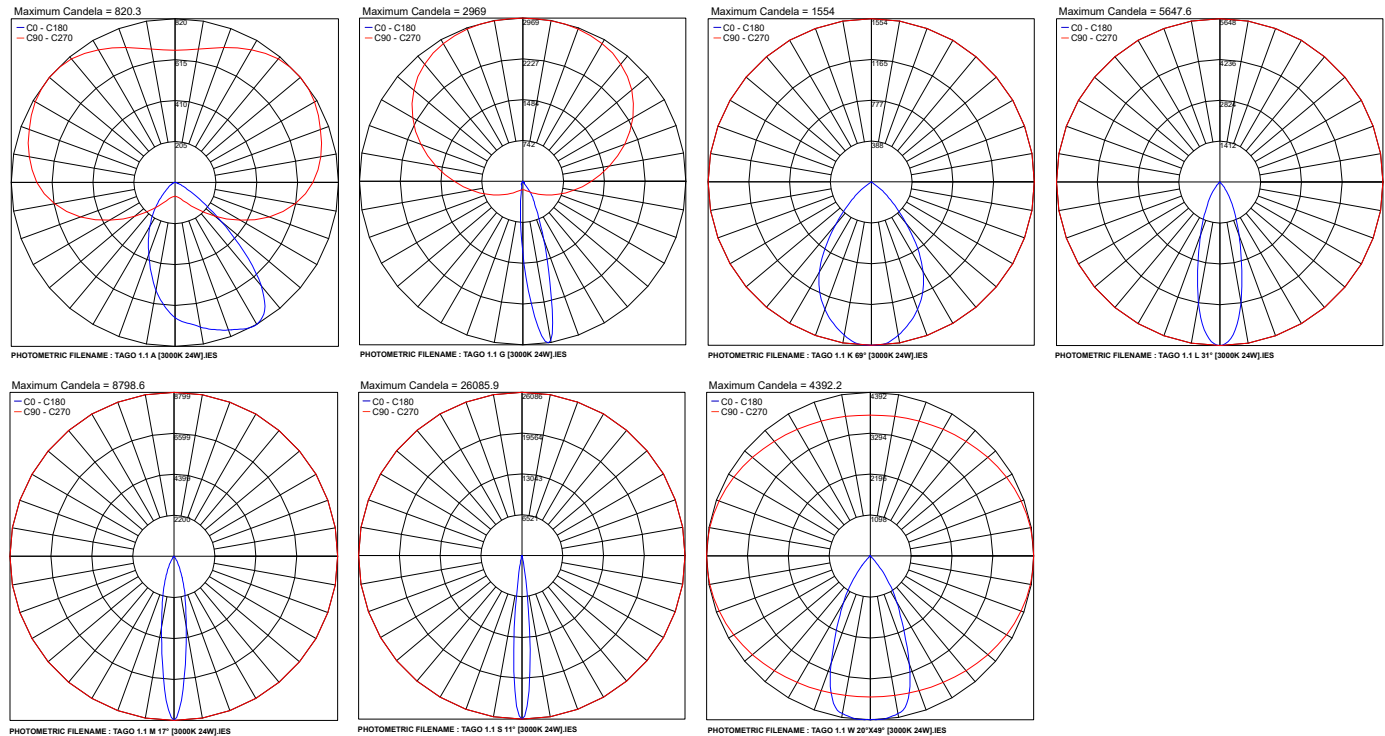

Job Name/Date:

Fixture Type Designation:

PHOTOMETRIC DATA

Note: all Photometry is 3000K

TAGO 1.3

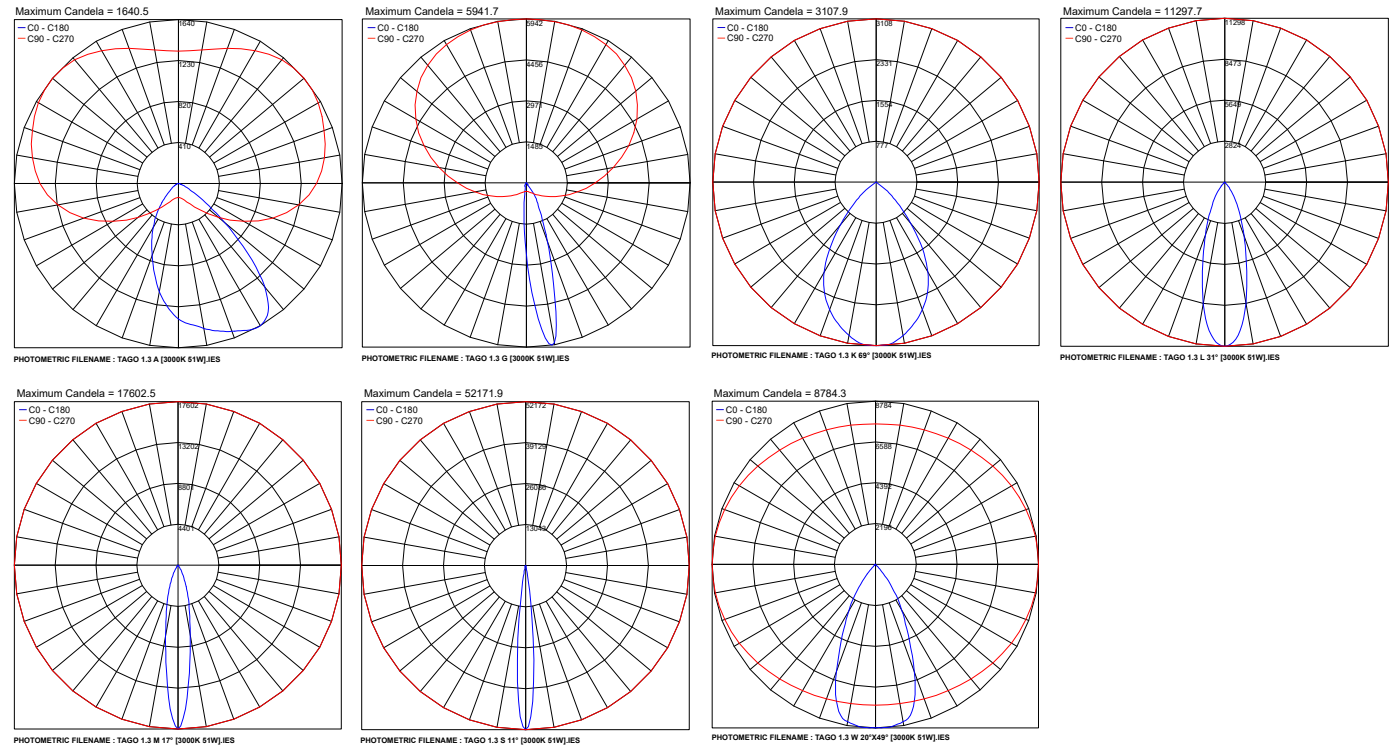

Job Name/Date:

Fixture Type Designation: