

# TAGO 1.0, 1.1, 1.3

Tago is an adjustable, driveover-rated, linear profile that is suitable for architectural lighting of facades of historic and public buildings, hotels and residential exteriors. It is available in 3 lengths with a wide range of optics and 4 color temperatures. Tago 1 series is the recessed version with regressed frame.



## TECHNICAL DATA

<b>Wattage</b>	14W, 24W, 51W
<b>Power Supply</b>	Integral 120-277VAC (0-10V Dimming)
<b>Construction</b>	Body: Anodized Anticorodal Aluminum Caps: Technopolymer Lens: Tempered, Serigraphed & Extra-Clear Glass Cable Length: 2 x 4.92'
<b>CCT</b>	2200K, 2700K, 3000K, 4000K
<b>CRI</b>	80
<b>BUG Rating</b>	B1-U1-G0 (Tago 1.0 - 29°) B2-U1-G0 (Tago 1.1 - 29°) B3-U1-G0 (Tago 1.3 - 29°)
<b>Delivered Lumens</b>	See Chart on page 2.
<b>Efficacy</b>	See Chart on page 2
<b>Optics</b>	7 Adjustable Available, see below
<b>Finishes</b>	Anodized Black
<b>Fixture Dimensions</b>	See Chart on page 2.
<b>Fixture Weight</b>	See Chart on page 2.
<b>Lumen Maintenance</b>	L80, B10>60,000hrs
<b>Color Consistency</b>	2-Step MacAdam, 3-Step MacAdam (2200K)
<b>Operating Temp.</b>	-4°F to +113°F
<b>IP Rating</b>	IP65, IP67, IP69
<b>Impact Rating</b>	IK09
<b>Driveover Capacity</b>	Up to 4409 lbs

## ORDERING INFORMATION

Example: TG10100201N0SN. Accessories ordered separately.

Model No.	Optical Accessories	CCT	Optics
TG101002 - Tago 1.0 (14W)	00 - None	N0 - 2200K	SN - 11° adjustable ±20°
TG111002 - Tago 1.1 (24W)	01 - Honeycomb Louvre*	F0 - 2700K	MN - 17° adjustable ±20°
TG131002 - Tago 1.3 (51W)	02 - Anti-Glare Shield**	50 - 3000K	LN - 29° adjustable ±20°
	NOTE: *Honeycomb Louvre only available on the 29°, 69°, and 20°x49° optics.	90 - 4000K	KN - 69° adjustable ±20°
	**Anti-Glare Shield only available on the 17°, 29°, 69°, and 20°x49° optics.		WN - 20°x49° adjustable ±20°
			GN - Wall Grazing adjustable ±20°
			AN - Wall Washer adjustable ±20°

Job Name/Date:

Fixture Type Designation:

## TECHNICAL DATA

	TAGO 1.0	TAGO 1.1	TAGO 1.3
<b>Wattage</b>	14W	24W	51W
<b>Delivered Lumens (3000K)</b>	932 lm (29°)	1864 lm (29°)	3728 lm (29°)
<b>Efficacy</b>	66.6 lm/W	77.7 lm/W	73.1 lm/W
<b>Fixture Dim. (l,w,h)</b>	12.68" x 3.23" x 4.65"	22.52" x 3.23" x 4.65"	42.20" x 3.23" x 4.65"
<b>Alum. Outer Casing Dim. (l,w,h)</b>	12.32" x 2.48" x 5.91"	19.80" x 2.48" x 5.91"	41.85" x 2.48" x 5.91"
<b>Fixture Weight</b>	2.9 lbs	4.6 lbs	9.0 lbs
<b>LED Source</b>	12 SMD LEDs, spacing 0.82"	24 SMD LEDs, spacing 0.82"	48 power LEDs, spacing 0.82"

## FIXTURE DIMENSIONS

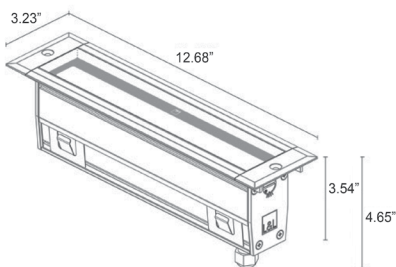

TAGO 1.0

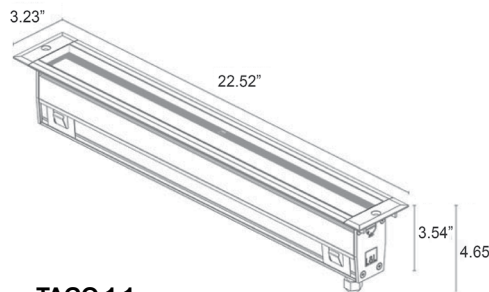

TAGO 1.1

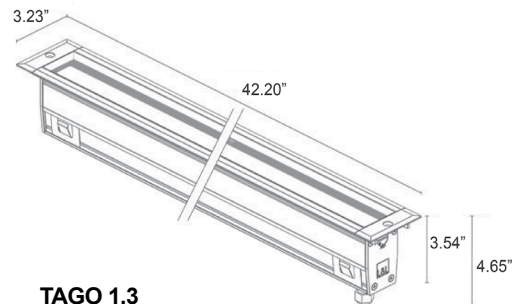

TAGO 1.3

## ADJUSTABILITY & ANTI-GLARE FEATURES

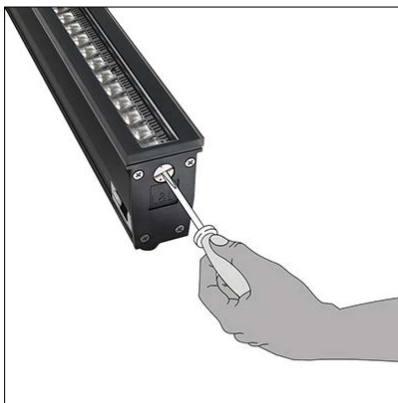

Tilting system is inside the optical unit. The light direction can be altered by  $\pm 20^\circ$  externally with a simple adjustment on the end caps, without compromising the fixture's IP65 or IP67 protection level.

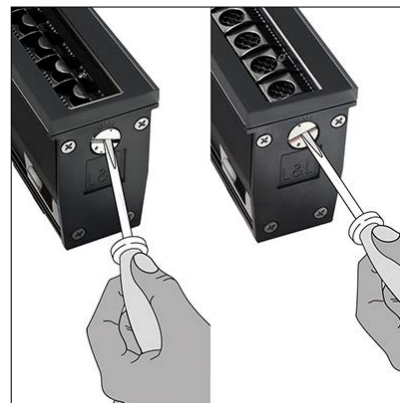

The honeycomb louvre or anti-glare shield, which can be ordered at the same time as the fixture, is mounted on the optical unit, so that the chosen option tilts together with the optics providing anti-glare solutions.

Job Name/Date:

Fixture Type Designation:

## ACCESSORIES - Installation

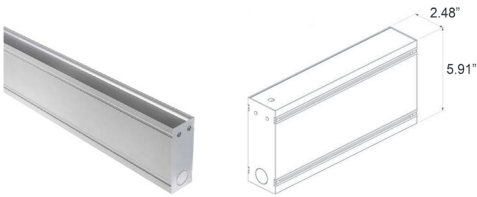

**WCTG10A0T** - Tago 1.0 (12.32")  
**WCTG11A0T** - Tago 1.1 (22.17")  
**WCTG13A0T** - Tago 1.3 (41.85")  
 Outer Casing

## Wiring Materials



**WFA0005**  
 required when daisy-chaining fixtures  
 that are more than 4.9 ft apart  
 16.40' Cable

**\*WFA04 & WFA0005**  
 must be ordered together



**WFA03-US (included)**  
 3-Pin Female Connector  
 For IP66-IP68 in/out connection



**WFA04-US**  
 required when daisy-chaining fixtures  
 that are more than 4.9 ft apart  
 3-Pin Male Connector  
 For IP66-IP68 in/out connection

## PHOTOMETRIC DATA

Note: all Photometry is 3000K

### TAGO 1.0

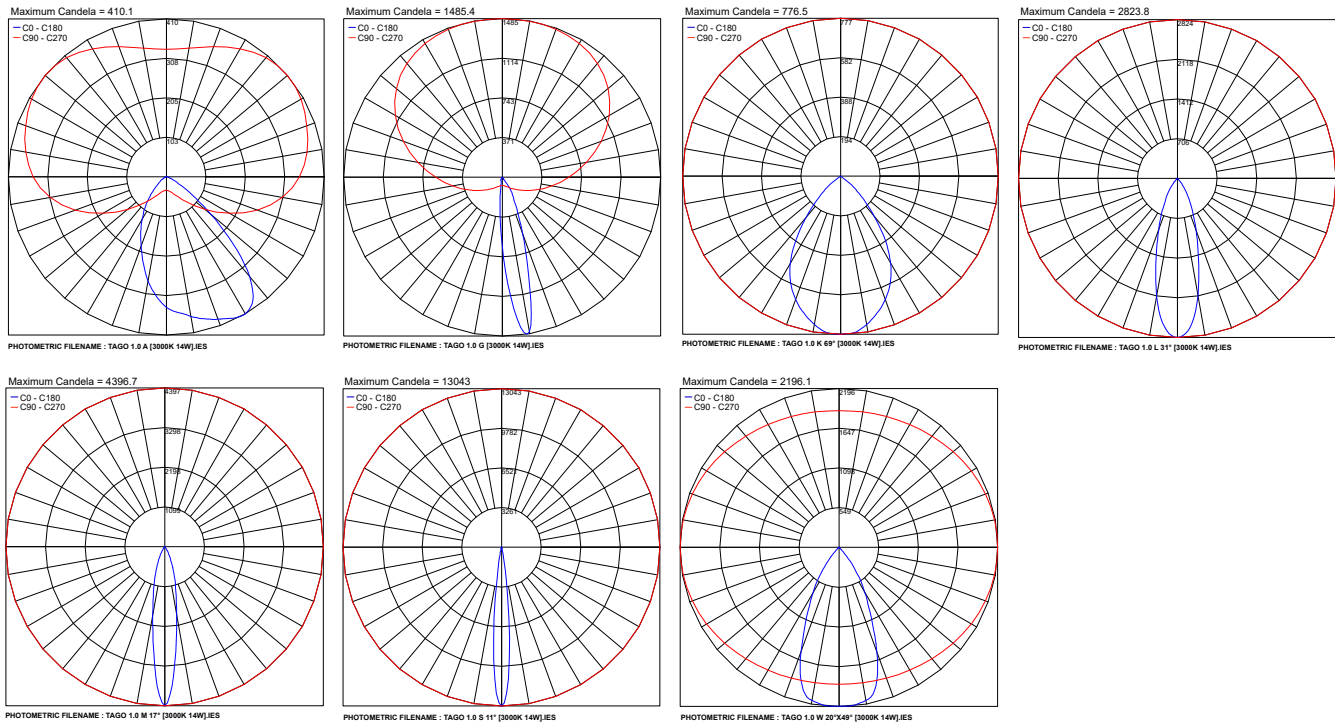

Job Name/Date:

Fixture Type Designation:

## PHOTOMETRIC DATA

Note: all Photometry is 3000K

### TAGO 1.1

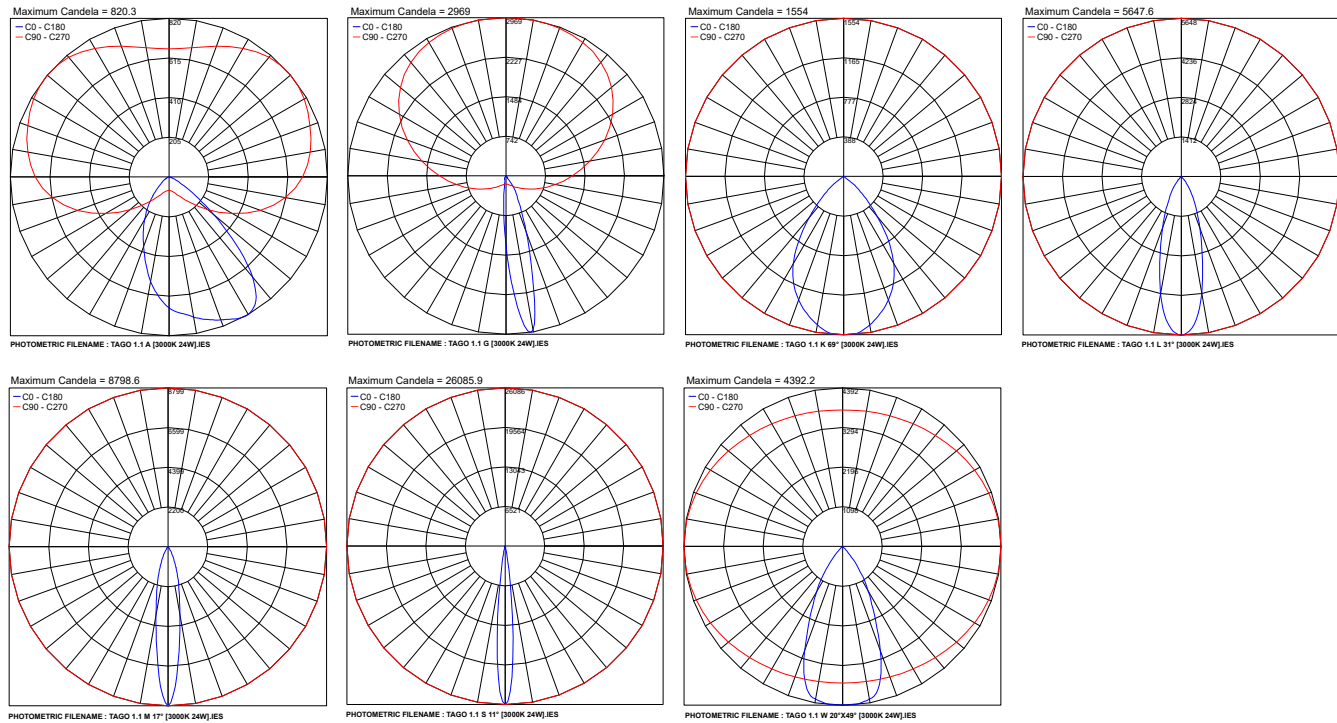

### TAGO 1.3

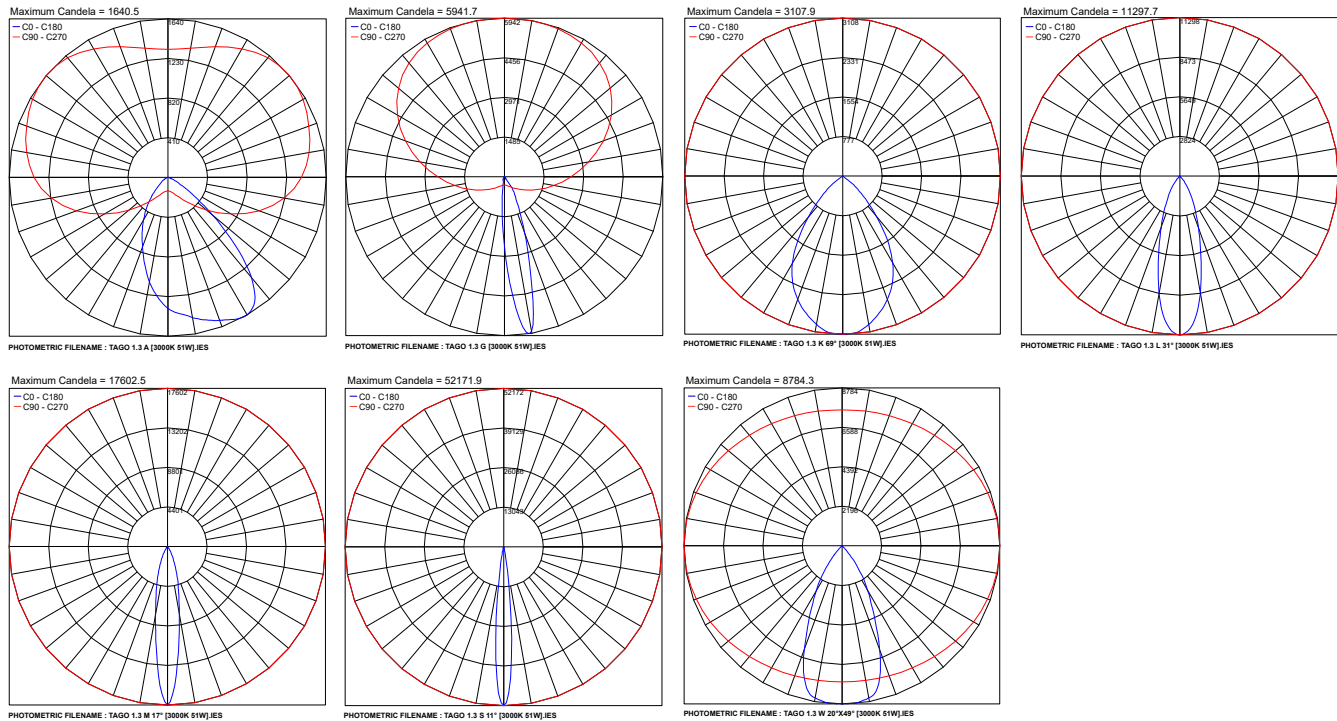

Job Name/Date:

Fixture Type Designation: