

The Bright 1 series are small, powerful and versatile fixtures. Available in numerous optics, styles and anti-glare accessories, this fixture can be installed wall or ceiling mounted.

TECHNICAL DATA

Wattage / Input	2W (500mA)
Power Supply	Remote, not included. See page 2.
Construction	Body/Trim: AISI 316L Stainless Steel Lens: Tempered Transparent or Frosted Glass Cable Length: 4.92'
CCT	7 Standard (see below)
CRI	>80
Delivered Lumens	88 lm (3000K)
Efficacy	44 lm/W (3000K)
Optics	4 Standard (see below)
Finishes	Stainless Steel, Custom RAL
Fixture Dimensions	1.38" l x 1.38" w x 2.05" h
Cut-out Size	Ø1.18" (for ceiling or wall installations)
Fixture Weight	0.44 lbs
LED Source	1 Power LED
Lumen Maintenance	L80 >50,000hrs (Ta 25°C)
Color Consistency	1/4 ANSI BIN
Operating Temp.	-4°F to +113°F
IP Rating	IP68
IK Rating	IK10



Cutout Dimensions for ceiling/wall installation mounted on a board = Ø 1.18"

Fixture Dimensions

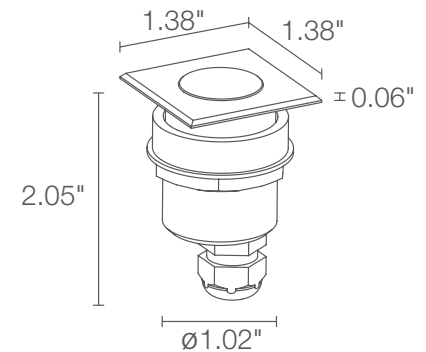

ORDERING INFORMATION

Example: **CB13125MAI**. Accessories / Power Supplies ordered separately.

CB1312			
Model No.	CCT	Optics	Finish
CB1312	F - 2700K 5 - 3000K 9 - 4000K 0 - 5000K 1 - Blue 2 - Green 3 - Red	S - 10° M - 20° L - 40° D - Diffuse	AI - Stainless Steel C - Custom RAL <i>(consult factory for "C")</i>

Job Name/Date:

Fixture Type Designation:

SUGGESTED POWER SUPPLIES

500mA

Part Number	Description	Input/Output	# of Fixtures
PPLT00497	Phase Dim (120V only)	120VAC to 500mA, 12W, Class 2	2-6
PPLT00467-P	0-10V Dimming to 1%	120-277VAC to 500mA, 50W, Class 2	1-16
PPLT00538-P	0-10V Dimming to 0.1%	120-277VAC to 500mA, 100W, Class 2	1-48

Suggested Lutron Compatible

Part Number	Option	Lutron SKU	Dim Range	Description	Input/Output	# of Fixtures
PPLT00249	LTEA2W	LTEA	100%-1%	Hi-Lume™ 1% 2-Wire LED Driver (120V forward phase only)	120VAC to 500mA, 10W, Class 2	4-5
PPLT00259	L3DAE / L3DA3W	L3DA	100%-1%	Hi-Lume™ 1% EcoSystem™ or 1% 3-Wire LED Driver	120-277VAC to 500mA, 10W, Class 2	4-5
PPLT00195	L3DAE / L3DA3W	L3DA	100%-1%	Hi-Lume™ 1% EcoSystem™ or 1% 3-Wire LED Driver	120-277VAC to 500mA, 19W, Class 2	6-9
PPLT00258	LTEA2W	LTEA	100%-1%	Hi-Lume™ 1% 2-Wire LED Driver (120V forward phase only)	120VAC to 500mA, 19W, Class 2	6-9
PPLT00180	L3DAE / L3DA3W	L3DA	100%-1%	Hi-Lume™ 1% EcoSystem™ or 1% 3-Wire LED Driver	120-277VAC to 500mA, 27W, Class 2	12-13
PPLT00250	LTEA2W	LTEA	100%-1%	Hi-Lume™ 1% 2-Wire LED Driver (120V forward phase only)	120VAC to 500mA, 27W, Class 2	12-13

For other power supply options consult factory.

ACCESSORIES

Anti-glare

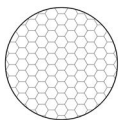

WH0101

Honeycomb Louvre
Not available diffuse optics

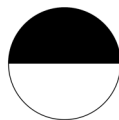

WE0500S

Anti-glare lens, half transparent and half serigraphed black
Available on 10°, 20°, 40° only

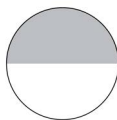

WE0500A

Semi-diffusing screen, half transparent and half frosted
Available on 10°, 20°, 40° only

Job Name/Date:

Fixture Type Designation:

PHOTOMETRIC DATA

Note all Photometry is 3000K

S - 10°

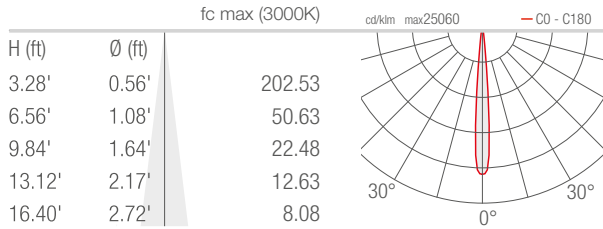

M - 20°

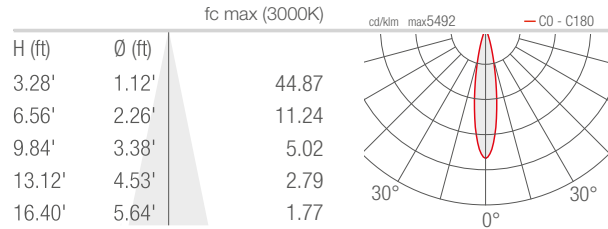

L - 40°

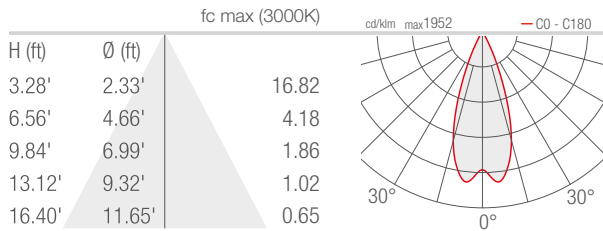

D - Diffuse

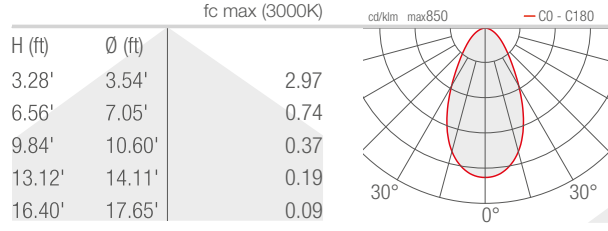

Job Name/Date:

Fixture Type Designation: