

The Bright 1 series are small, powerful and versatile fixtures. Available in numerous optics, styles and anti-glare accessories, this fixture can be installed in-grade, wall mount or ceiling mount. **The Bright 1, Smoothy 1 and Litus 1 series all use the same LED.**



TECHNICAL DATA

Wattage / Input	2W (24VDC)
Power Supply	Remote, not included. See page 2.
Construction	Body/Trim: AISI 316L Stainless Steel Lens: Tempered Transparent or Frosted Glass Cable Length: 4.92' standard
CCT	2700K, 3000K, 4000K, 5000K, Blue
CRI	>80
Delivered Lumens	127 lm (3000K, 21°)
Efficacy	63.5 lm/W (3000K, 21°)
Optics	7 Standard (see below)
Finishes	Stainless Steel, Custom RAL
Fixture Dimensions	1.38" l x 1.38" w x 2.05" h
Cut-out Size	Ø1.18" (for ceiling or wall installations)
Fixture Weight	0.44 lbs
LED Source	1 Power LED
Lumen Maintenance	60,000hrs L90 B10 (Ta 25°C)
Color Consistency	2-Step MacAdam
Operating Temp.	-4°F to +113°F
IP Rating	IP65, IP68
IK Rating	IK10

Cutout Dimensions for ceiling/wall installations with fixing spring = Ø 1.18"

Fixture Dimensions

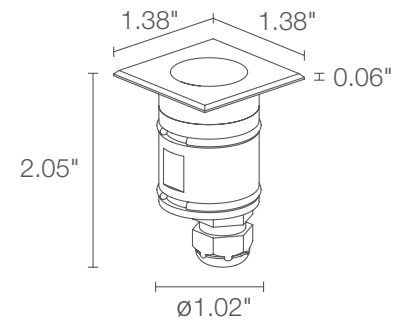

ORDERING INFORMATION

Example: CB17005MI or CB17005MI-3. Accessories / Power Supplies ordered separately.

CB1700				
Model No.	CCT	Optics	Finish	Cable Length
CB1700	F - 2700K 5 - 3000K 9 - 4000K 0 - 5000K 1 - Blue	S - 10° M - 21° L - 43° D - Diffuse	I - Stainless Steel C - Custom RAL <i>(consult factory for "C")</i>	4.92' standard 1 - 16.40' 2 - 32.81' 3 - 49.21' 4 - 65.62'

Job Name/Date:

Fixture Type Designation:

SUGGESTED POWER SUPPLIES

24VDC

Part Number	Description	Input/Output	# of Fixtures
PPLT00149	Non-Dim	120VAC to 24VDC, 10W, Class 2, IP65	1-4
PPLT00632	0-10V Dimming (Dim to Off)	120-277VAC to 24VDC, 12W, Class 2	1-4
PPLT00155	Non-Dim	120VAC to 24VDC, 30W, Class 2	1-12
PPLT00157	Non-Dim	120VAC to 24VDC, 60W, Class 2	1-24
PPLT00599	ELV / TRIAC & 0-10V Dimming (100 to 0%)	120-277VAC to 24VDC, 96W, Class 2	1-38
PPLT00158	Non-Dim	120VAC to 24VDC, 100W, Class 2	1-40
PPLT00543	0-10V Dimming to 15% (-40°C / -40°F cold weather start)	120-277VAC to 24VDC, 100W, Class 2	5-40

For other power supply options consult factory.

ACCESSORIES

Installation

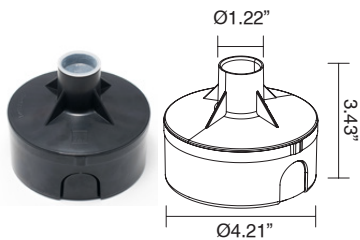

WC0202
Outer Casing



WG0301
Fixing Spring
For ceiling/wall use

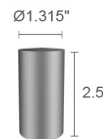

PPMP02674
Core Drilled
Application Sleeve

Anti-glare

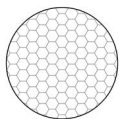

WH0101
Honeycomb Louvre
Not available diffuse optics

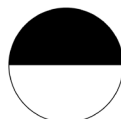

WE0500S
Anti-glare lens, half transparent and half serigraphed black
Available on 10°, 20°, 40° only

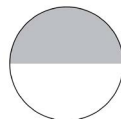

WE0500A
Semi-diffusing screen, half transparent and half frosted
Available on 10°, 20°, 40° only

Job Name/Date:

Fixture Type Designation:

PHOTOMETRIC DATA

Note all Photometry is 3000K

S - 10°

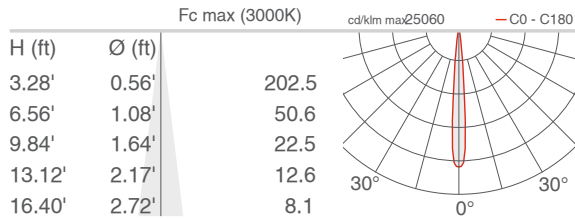

V - 21° sharp (Bright 1.0 / 1.6)

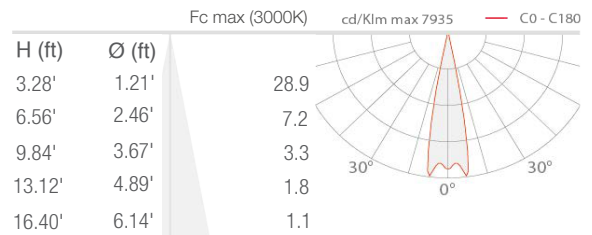

M - 21°

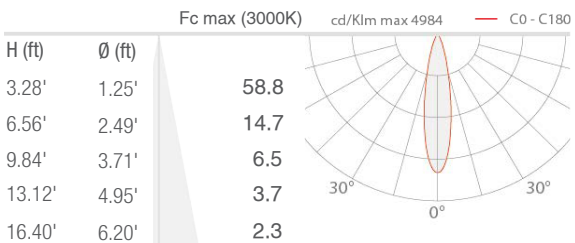

L - 43°

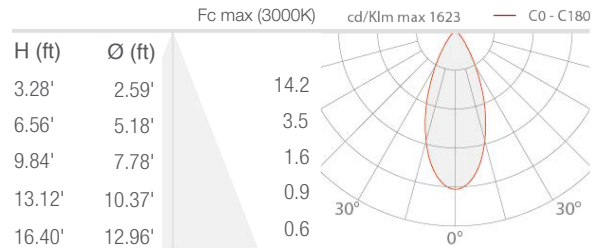

T - 54° sharp (Bright 1.0 / 1.6)

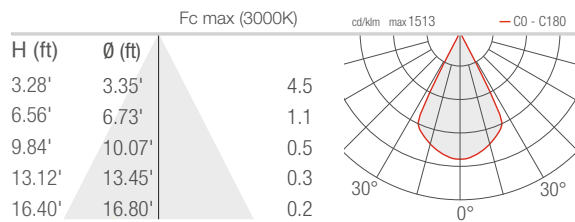

W - 15°x38° (Bright 1.0 / 1.2 / 1.6)

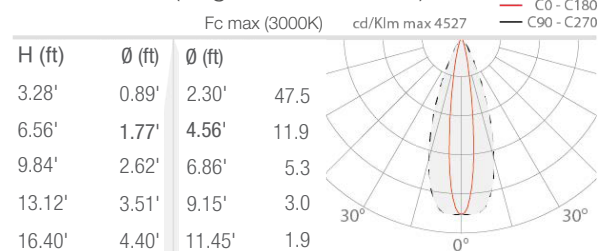

D - Diffuse

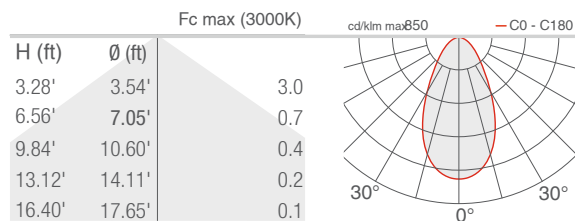

Job Name/Date:

Fixture Type Designation: