

BRIGHT 1.B

The Bright 1 series are small, powerful and versatile fixtures. Available in numerous optics, styles and anti-glare accessories. Bright 1.B is a step light with radial optics that is available in 4 color temperatures and a stainless steel finish. **The Bright 1, Smoothy 1 and Litus 1 series all use the same LED.**

TECHNICAL DATA

Wattage / Input	2.5W, 3.5W (24VDC)
Power Supply	Remote, not included. See page 2.
Construction	Body/Trim: AISI 316L Stainless Steel Cable Length: 4.92' standard
CCT	2700K, 3000K, 4000K, Blue
CRI	>80
Delivered Lumens	38 lm (3000K, 4x60°, 2.5W) 56 lm (3000K, 4x60°, 3.5W)
Efficacy	15.2 lm/W (3000K, 4x60°, 2.5W) 16 lm/W (3000K, 4x60°, 3.5W)
Optics	6 Standard Radial (see below)
Finishes	Stainless Steel, Custom RAL
Fixture Dimensions	Ø1.38" x 2.48" h
Cut-out Size	Ø1.18" (for ceiling or wall installations)
Fixture Weight	0.44 lbs
LED Source	1 Power LED
Lumen Maintenance	L80 >50,000hrs (Ta 25°C)
Color Consistency	1/4 ANSI BIN
Operating Temp.	-4°F to +113°F
IP Rating	IP67
IK Rating	IK10



Cutout Dimensions for ceiling/wall installations with fixing spring = Ø 1.18"

Fixture Dimensions

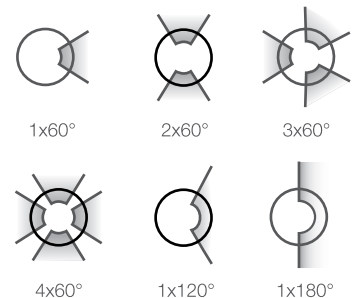
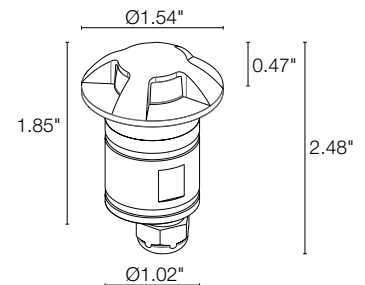

ORDERING INFORMATION

Example: CB1B00FR4TI or CB1B00FR4TI-2. Accessories / Power Supplies ordered separately.

CB1B0					
Model No.	Wattage	CCT	Optics	Finish	Cable Length
CB1B0	00 - 2.5W 10 - 3.5W	F - 2700K 5 - 3000K 9 - 4000K 1 - Blue	R1 - 1x60° R2 - 2x60° R3 - 3x60° R4 - 4x60° R5 - 1x120° R6 - 1x180°	TI - Stainless Steel TC - Custom RAL (consult factory for "C")	4.92' standard 1 - 16.40' 2 - 32.81' 3 - 49.21' 4 - 65.62'

Job Name/Date:

Fixture Type Designation:

SUGGESTED POWER SUPPLIES

24VDC

Part Number	Description	Input/Output	# of Fixtures	
			2.5W	3.5W
PPLT00056	Non-Dim	120-277VAC to 24VDC, 26W, Class 2, IP66	1-8	1-5
PPLT00157	Non-Dim	120VAC to 24VDC, 60W, Class 2	1-19	1-13
PPLT00599	ELV / TRIAC & 0-10V Dimming (100 to 0%)	120-277VAC to 24VDC, 96W, Class 2	1-30	1-21
PPLT00143	0-10V Dimming (to 10%)	120-277VAC to 24VDC, 96W, Class 2, IP64	1-30	1-21
PPLT00158	Non-Dim	120-277VAC to 24VDC, 100W, Class 2	1-32	1-22
PPLT00543	0-10V Dimming to 15% (-40°C / -40°F cold weather start)	120-277VAC to 24VDC, 100W, Class 2	4-32	3-22

For other power supply options consult factory.

ACCESSORIES

Installation

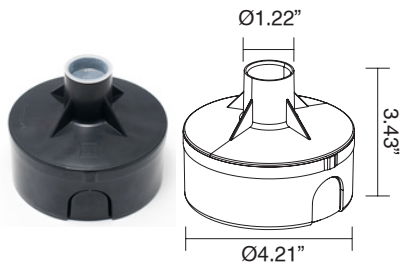

WC0202
Outer Casing

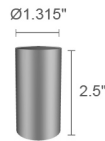

PPMP02674
Core Drilled
Application Sleeve

Job Name/Date:

Fixture Type Designation:

PHOTOMETRIC DATA

Note all Photometry is 3000K, 3.5W

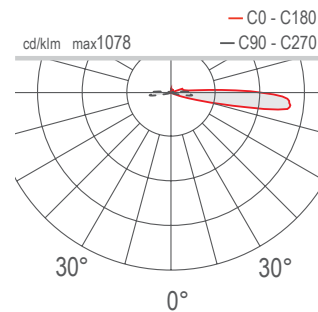
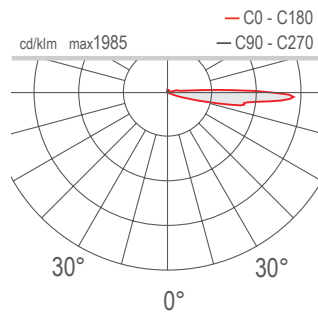
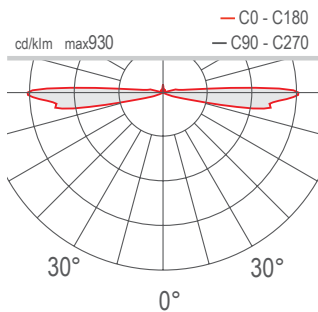
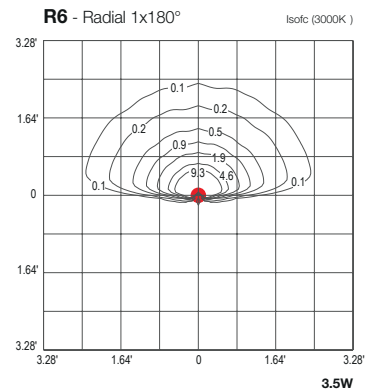
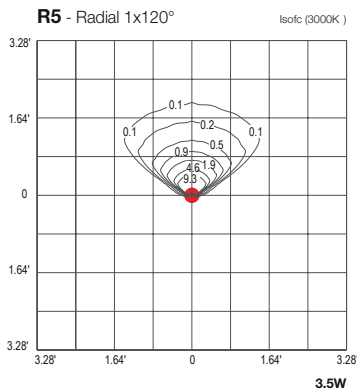
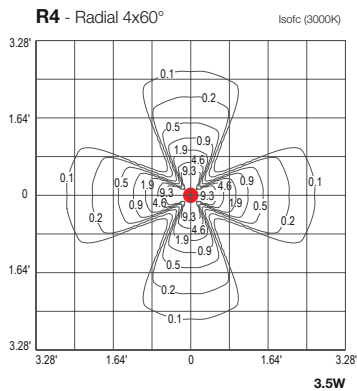
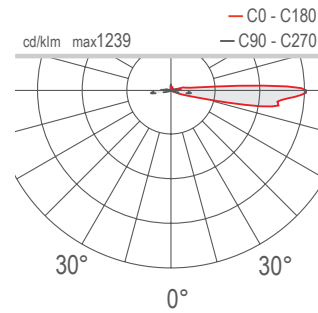
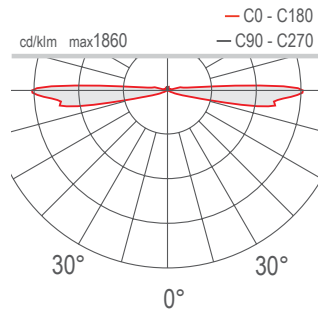
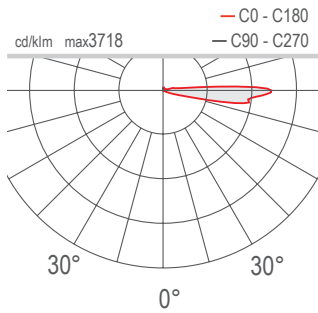
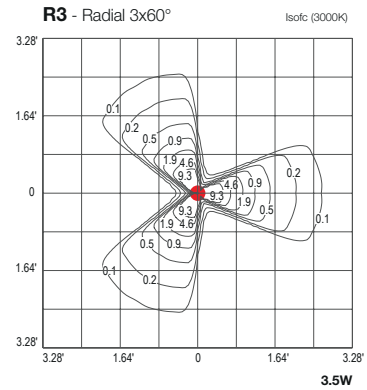
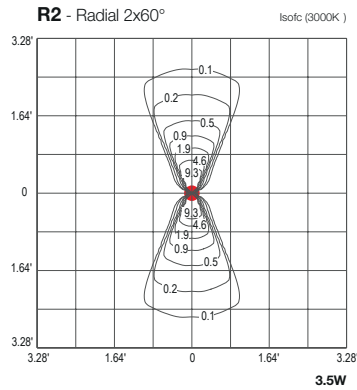
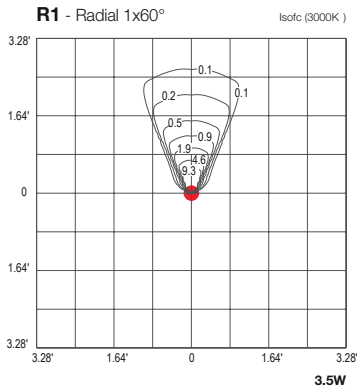

Job Name/Date:

Fixture Type Designation: