

# BRIGHT 2.4

The Bright 2 series are small, powerful and versatile fixtures. Available in numerous optics, styles and anti-glare accessories, this fixture can be installed in-grade, wall mount or ceiling mount. Suitable for power washing - not suitable for fountains or pools. **The Bright 2, Smoothy 2 and Litus 2 series all use the same LED.**

## TECHNICAL DATA

<b>Wattage / Input</b>	5W, 7W (24VDC), 5W (500mA, RGB)
<b>Power Supply</b>	Remote, not included. See page 2.
<b>Construction</b>	Body/Trim: Anodized Aluminum/Stainless Steel Lens: Tempered Extra-Clear Glass Cable Length: 4.92' standard
<b>CCT</b>	2700K, 3000K, 4000K; RGB (3500K on request - not available on 8° or 21°x42° optics)
<b>CRI</b>	>80, >90
<b>Delivered Lumens</b>	See Delivered Lumens Chart RGB 191 lm: (R) 70 lm, (G) 90 lm, (B) 31 lm
<b>Efficacy</b>	57-70 lm/W (5W), 53-66 lm/W (7W), 38 lm/W (RGB)
<b>Optics</b>	12 Standard (White), 4 Standard (RGB)
<b>Finishes</b>	3 Standard (See below)
<b>Fixture Dimensions</b>	Ø3.39" x 2.48" h
<b>Cut-out Size</b>	Ø2.76" (for ceiling or wall installations)
<b>Fixture Weight</b>	0.97 lbs (Stainless Steel) 0.73 lbs (Aluminum)
<b>LED Source</b>	1 High-Intensity Power LED (White) 3 Power LEDs (RGB)
<b>Lumen Maintenance</b>	L90, B10 >50,000hrs (Ta 25°C)
<b>Color Consistency</b>	3-Step MacAdam (White)
<b>Operating Temp.</b>	-4°F to +113°F
<b>IP Rating</b>	IP68, IP69K
<b>IK Rating</b>	IK10



Cutout Dimensions for ceiling/wall installations with fixing spring = Ø2.76"

Fixture Dimensions

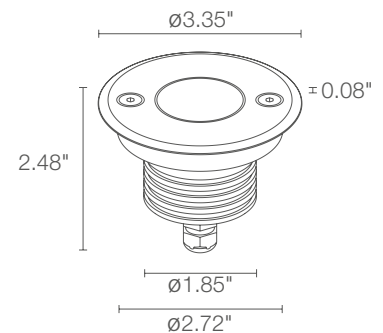

<b>Delivered Lumens (3000K, 34°)</b>	5W	7W
<b>CRI 80</b>	352 lm	463 lm
<b>CRI 90</b>	284 lm	374 lm

## ORDERING INFORMATION

Example: CB24001FTAI or CB24001FTAI-1. Accessories / Power Supplies ordered separately.

Model No.	CRI	CCT	Optics	Finish (Body/Trim)	Cable Length
CB2400 - 5W	0 - 80 CRI	F - 2700K	Z - Asymmetrical 8° M - 34° W - 13° x 52°	AF - Aluminum/Gray	4.92' standard
CB2401 - 7W	1 - 90 CRI	5 - 3000K	V - 8° L - 45° D - Diffuse	AI - Aluminum/SS	1 - 16.40'
Static White Only		9 - 4000K	T - 11° J - 47°	II - SS / SS	2 - 32.81'
			S - 17° Q - 61° sharp	Note* SS: Stainless Steel	3 - 49.21'
			P - 21° sharp K - 68°		4 - 65.62'
Model No.		CCT	Optics		
CB2432 - 5W		6 - RGB	S - 20° L - 45°		
RGB Only			M - 34° W - 21° x 42°		

Job Name/Date:

Fixture Type Designation:

## SUGGESTED POWER SUPPLIES

24VDC

Part Number	Description	Input/Output	# of Fixtures 5W / 7W	
<a href="#">PPLT00632</a>	0-10V Dimming (Dim to Off)	120-277VAC to 24VDC, 12W, Class 2	1-1	1-1
<a href="#">PPLT00056</a>	Non-Dim	120-277VAC to 24VDC, 26W, Class 2, IP66	1-4	1-2
<a href="#">PPLT00157</a>	Non-Dim	120VAC to 24VDC, 60W, Class 2	1-9	1-6
<a href="#">PPLT00599</a>	ELV / TRIAC & 0-10V Dimming (100 to 0%)	120-277VAC to 24VDC, 96W, Class 2	1-15	1-10
<a href="#">PPLT00158</a>	Non-Dim	120VAC to 24VDC, 100W, Class 2	1-16	1-11
<a href="#">PPLT00543</a>	0-10V Dimming to 15% (-40°C / -40°F cold weather start)	120-277VAC to 24VDC, 100W, Class 2	2-16	2-11

500mA - RGB

Part Number	Description	Input/Output	# of Fixtures 5W
<a href="#">PPLT00244-P</a>	DMX / RDM (Must advise DMX addresses if not using RDM)	120-277VAC to 500mA, 50W, Class 2	1-7
<a href="#">PPLT00129-P</a>	DMX / RDM (Field Addressable)	120-277VAC to 500mA, 100W, Class 2	1-12

For other power supply options consult factory.

Job Name/Date:

Fixture Type Designation:

## ACCESSORIES - Installation



**WC0100**  
Outer Casing  
For in-grade use



**WC0103**  
Outer Casing  
For in-grade use

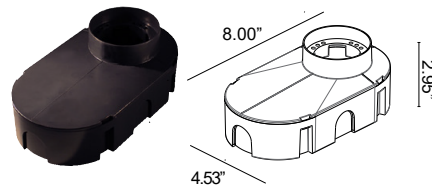

**WC0150**  
Outer Casing  
For in-grade use



**WG0100**  
Fixing Spring  
For ceiling/wall use

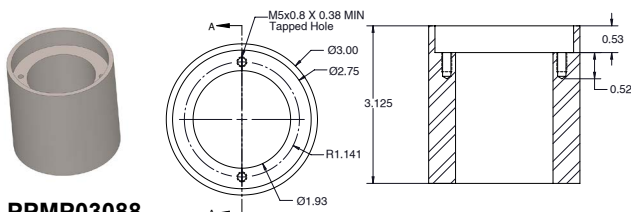

**PPMP03088**  
Core Drilled Application Sleeve

## Anti-glare

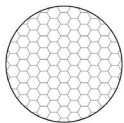

**WH0201**  
Honeycomb Louvre  
Not available for sharp, asymmetrical 8°, 8° and diffuse optics

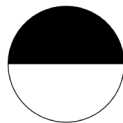

**WE0400S**  
Anti-glare lens, half transparent and half serigraphed black  
Not available for diffuse, asymmetrical 8° optics or RGB versions

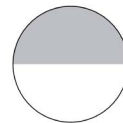

**WE0400A**  
Semi-diffusing lens, half transparent and half frosted  
Not available for diffuse, asymmetrical 8° optics or RGB versions

Job Name/Date:

Fixture Type Designation:

## PHOTOMETRIC DATA

Note all Photometry is 3000K, CRI 80

### Z - Asymmetrical 8°

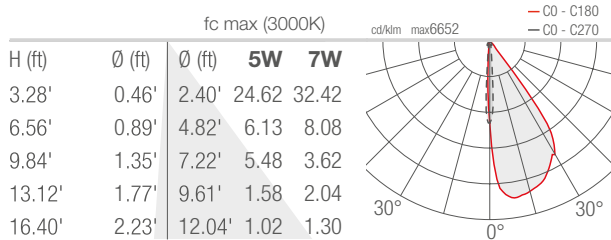

### V - 8° CRI 80

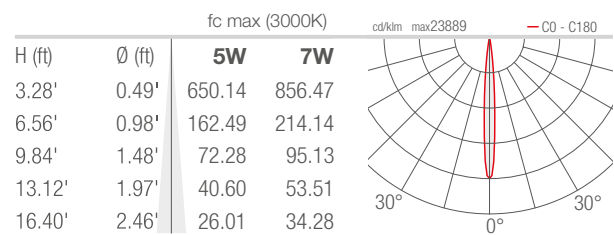

### T - 11° CRI 80

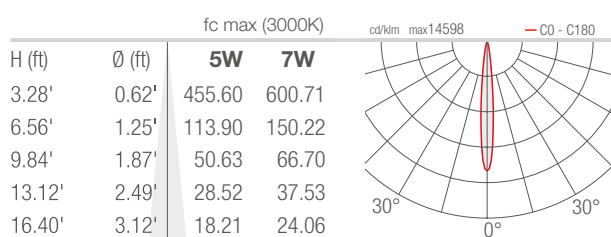

### S - 17° CRI 80

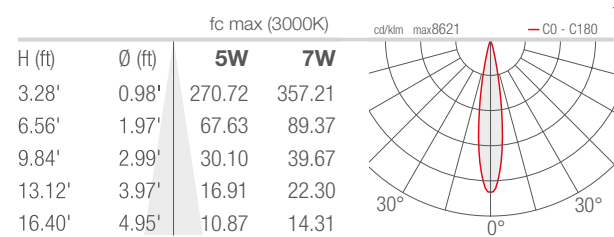

### P - 21° sharp CRI 80

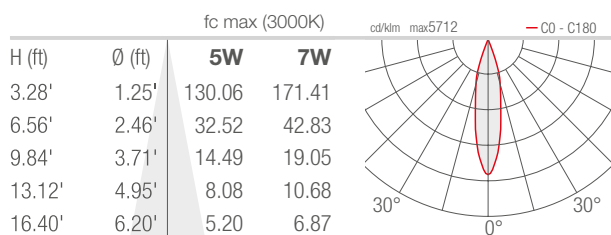

### M - 34° CRI 80

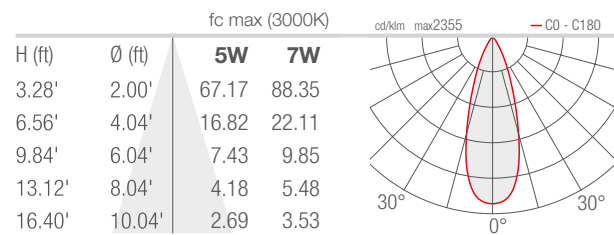

### L - 45° CRI 80

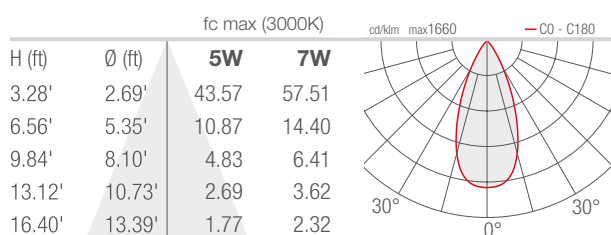

### J - 47° CRI 80

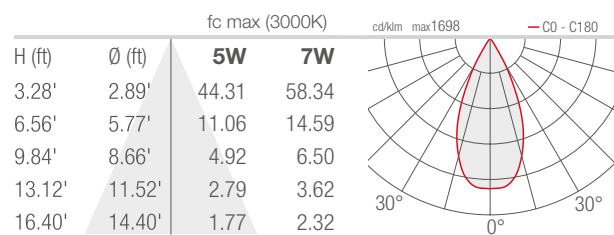

Job Name/Date:

Fixture Type Designation:

## PHOTOMETRIC DATA

Note all Photometry is 3000K, CRI 80

### Q - 61° sharp CRI 80

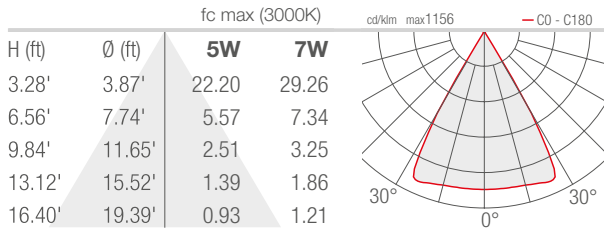

### K - 68° CRI 80

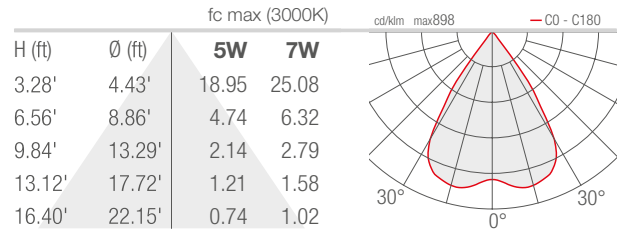

### W - 13°x52° CRI 80

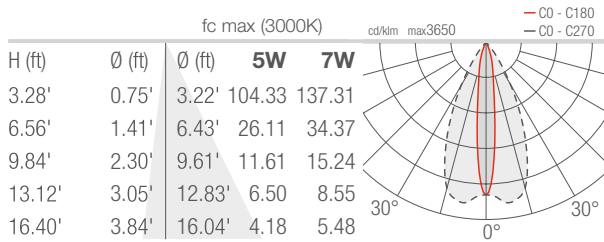

### D - Diffuse - sandblasted

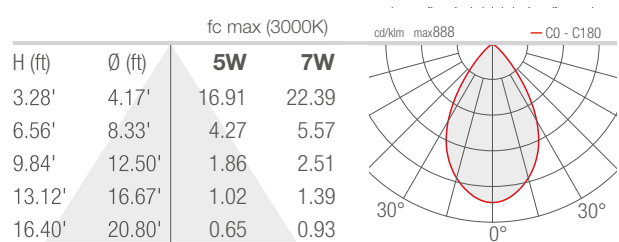

Job Name/Date:

Fixture Type Designation: