

CAMEO 2.7

The Cameo 2.7 is a small adjustable recessed downlight for indoor applications. With $\pm 20^\circ$ tiltable optics and 360° rotation, the fixture is ideal for tight plenums, false ceilings and niches in plasterboard.



TECHNICAL DATA

Wattage / Input	5W (24VDC)
Power Supply	Remote, not included. See page 2.
Construction	Body/Trim: Aluminum Alloy EN AW 6026 Cable Length: 4.92'
CCT	2700K, 3000K, 4000K (3500K on request, consult factory)
CRI	>90
Delivered Lumens	303 lm (3000K, 32°)
Efficacy	60.6 lm/W (3000K, 32°)
Optics	6 Standard (see below)
Finishes	White, Black, Custom RAL
Fixture Dimensions	$\varnothing 2.72"$ x 1.89" h
Cut-out Size	$\varnothing 2.56"$ (for ceiling installations)
Fixture Weight	0.33 lbs
LED Source	1 Power High Intensity LED
Lumen Maintenance	L95, B10 >50,000hrs (Ta 25°C)
Color Consistency	3-Step MacAdam
Operating Temp.	32°F to +113°F
IP Rating	IP40
IK Rating	-

Cutout Dimensions for ceiling installations = $\varnothing 2.56"$

Fixture Dimensions

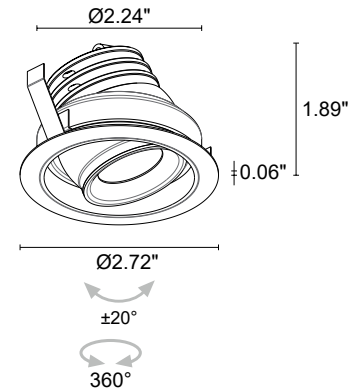

ORDERING INFORMATION

Example: CM27001000F0SN. Power Supplies / Accessories ordered separately.

CM27001000			
Model No.	CCT	Optics	Finish
CM27001000	F0 - 2700K 50 - 3000K 90 - 4000K	S - 11° tiltable $\pm 20^\circ$ M - 17° tiltable $\pm 20^\circ$ P - 19° sharp tiltable $\pm 20^\circ$ L - 32° tiltable $\pm 20^\circ$ J - 65° tiltable $\pm 20^\circ$ W - 13° x 43° tiltable $\pm 20^\circ$	E - White N - Black C - Custom RAL (Consult factory for "C")

Job Name/Date:

Fixture Type Designation:

SUGGESTED POWER SUPPLIES

24VDC

Part Number	Description	Input/Output	# of Fixtures
PPLT00149	Non-Dim	120VAC to 24VDC, 10W, Class 2, IP65	1-1
PPLT00632	0-10V Dimming (Dim to Off)	120-277VAC to 24VDC, 12W, Class 2	1-1
PPLT00481	Non-Dim	120-277VAC to 24VDC, 24W, Class 2	1-3
PPLT00157	Non-Dim	120VAC to 24VDC, 60W, Class 2	1-9
PPLT00599	ELV / TRIAC & 0-10V Dimming (100 to 0%)	120-277VAC to 24VDC, 96W, Class 2	1-15
PPLT00543	0-10V Dimming to 15% (-40°C / -40°F cold weather start)	120-277VAC to 24VDC, 100W, Class 2	2-16

For other power supply options consult factory.

ACCESSORIES - Installation

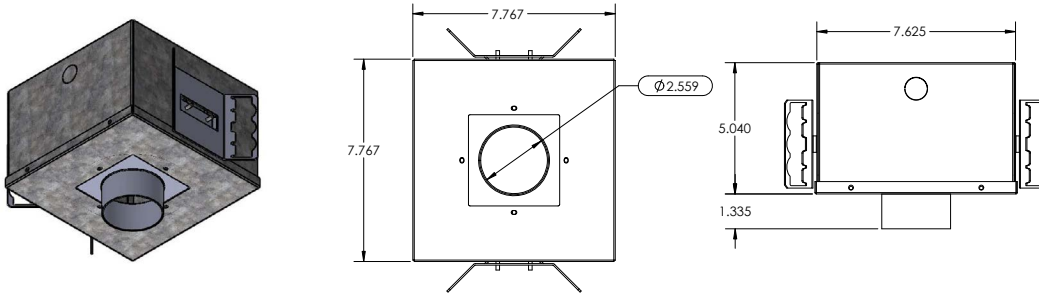

AH-00010-IC (IC Rated)

AH-00010-CP (Chicago Plenum Rated)

Housing for recessed installation in ceilings.

Job Name/Date:

Fixture Type Designation:

PHOTOMETRIC DATA

Note all Photometry is 3000K

S - 11°

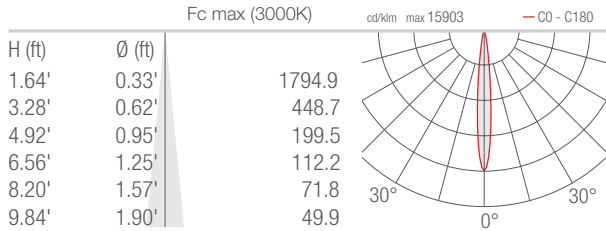

M - 17°

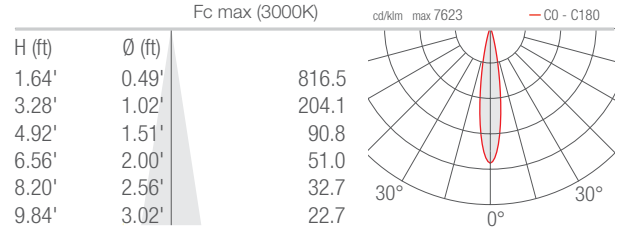

P - 19° Sharp

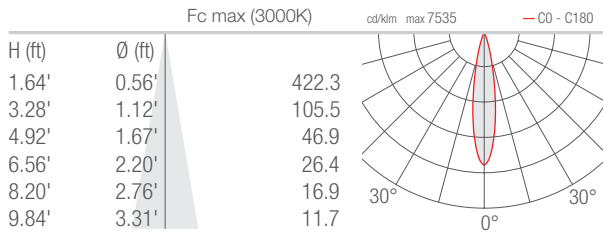

L - 32°

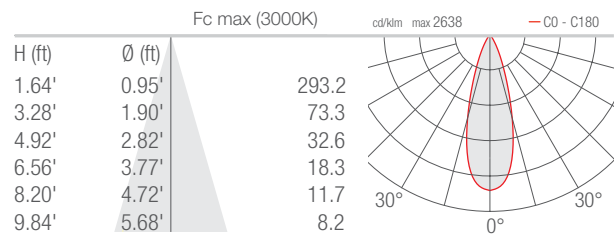

J - 65°

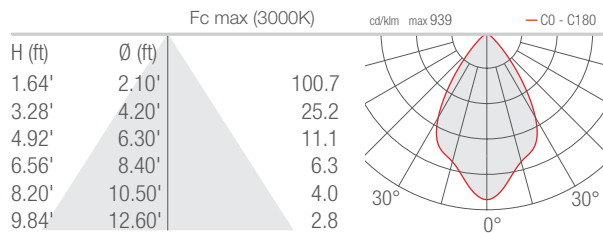

W - 13°x43°

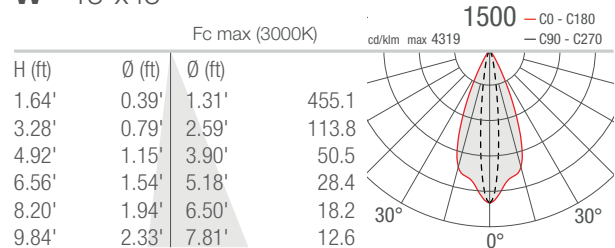

Job Name/Date:

Fixture Type Designation: