

KRILL 3.4

Krill 3.4 is a small, adjustable zoom, surface mounted floodlight with a pared-down design for indoor applications. The fixture is ideal for inside shop windows and display cabinets in retail and museum environments. Krill can be installed in a variety of ways to easily reach details that need emphasizing with a double-jointed arm that can be adjusted by up to 180°.



TECHNICAL DATA

Wattage / Input	4.5W (350mA)
Power Supply	Remote, not included. See page 2.
Construction	Body: Anticorodal Aluminum Joint: Brass Cable Length: 4.92'
CCT	2700K, 3000K, 4000K
CRI	>90
Delivered Lumens	253 lm (3000K, 80°)
Efficacy	56.2 lm/W (3000K, 80°)
Optics	Range 18°-80° (manual zoom)
Finishes	4 Standard, Custom RAL on request (see below)
Fixture Dimensions	Ø1.18" x 1.57"-2.05" h
Base Size	Ø0.41"
Fixture Weight	0.17 lbs
LED Source	1 High Intensity Power LED
Lumen Maintenance	L90, B10 >50,000hrs (Ta 25°C)
Color Consistency	3-step MacAdam
Operating Temp.	32°F to +113°F
IP Rating	IP40

Fixture Dimensions

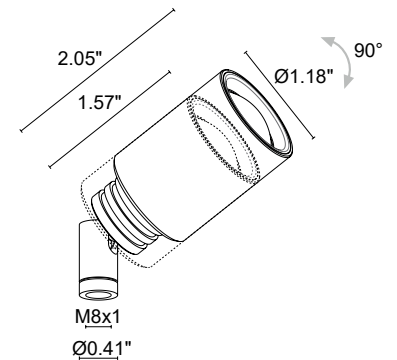

Required installation accessories, not included. See page 2.

ORDERING INFORMATION

Example: **KI342010005R1Y**. Power Supplies / Required Accessories ordered separately.

KI34201000		R1	
Model No.	CCT	Optics	Finish
KI34201000	F - 2700K 5 - 3000K 9 - 4000K	R1 - 18°-80°	E - White N - Black Y - Rose Gold Z - Antique Bronze C - Custom RAL (Consult factory for "C")

Job Name/Date:

Fixture Type Designation:

SUGGESTED POWER SUPPLIES

350mA

Part Number	Description	Input/Output	# of Fixtures
PPLT00148	0-10V Dimming to 10%	120-277VAC to 350mA, 6W, Class 2	1-1
PPLT00496	Phase Dim (120V only)	120VAC to 350mA, 12W, Class 2	1-2
PPLT00480-P	0-10V Dimming to 1.0%	120-277VAC to 350mA, 30W, Class 2	1-4
PPLT00263	Leading / Trailing Edge Dimming to 10% (120V only)	120-277VAC to 350mA, 32W, Class 2	2-3
PPLT00309-P	0-10V Dimming to 0.1%	120-277VAC to 350mA, 50W, Class 2	1-4
PPLT00538-P	0-10V Dimming to 0.1%	120-277VAC to 350mA, 100W, Class 2	1-16

Suggested Lutron Compatible

Part Number	Option	Lutron SKU	Dim Range	Description	Input/Output	# of Fixtures
PPLT00252	LTEA2W	LTEA	100%-1%	Hi-Lume™ 1% 2-Wire LED Driver (120V forward phase only)	120VAC to 350mA, 7W, Class 2	1-1
PPLT00247	L3DAE / L3DA3W	L3DA	100%-1%	Hi-Lume™ 1% EcoSystem™ or 1% 3-Wire LED Driver	120-277VAC to 350mA, 7W, Class 2	1-1
PPLT00516	L3DAE / L3DA3W	L3DA	100%-1%	Hi-Lume™ 1% EcoSystem™ or 1% 3-Wire LED Driver	120-277VAC to 350mA, 13W, Class 2	2-2
PPLT00271	LTEA2W	LTEA	100%-1%	Hi-Lume™ 1% 2-Wire LED Driver (120V forward phase only)	120VAC to 350mA, 13W, Class 2	2-2
PPLT00179	L3DAE / L3DA3W	L3DA	100%-1%	Hi-Lume™ 1% EcoSystem™ or 1% 3-Wire LED Driver	120-277VAC to 350mA, 19W, Class 2	3-4
PPLT00220	LTEA2W	LTEA	100%-1%	Hi-Lume™ 1% 2-Wire LED Driver (120V forward phase only)	120VAC to 350mA, 19W, Class 2	3-4

For other power supply options consult factory.

Job Name/Date:

Fixture Type Designation:

ACCESSORIES - Installation

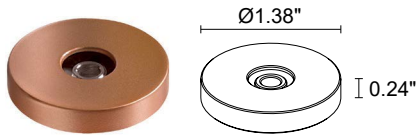

WDA00E - White
WDA00N - Black
WDA00Y - Rose Gold
WDA00Z - Antique Bronze
 Fixing Base

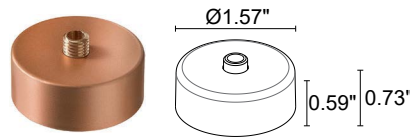

WDA03E - White
WDA03N - Black
WDA03Y - Rose Gold
WDA03Z - Antique Bronze
 Ceiling Canopy

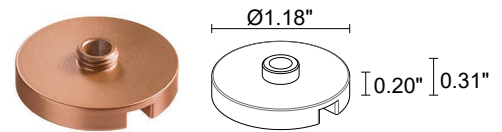

WDA04E - White
WDA04N - Black
WDA04Y - Rose Gold
WDA04Z - Antique Bronze
 Magnetic Plate

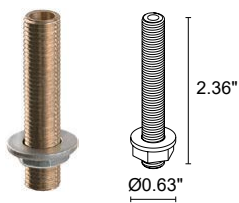

WGA01
 Coupler

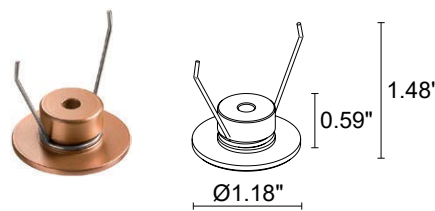

WGA08E - White
WGA08N - Black
WGA08Y - Rose Gold
WGA08Z - Antique Bronze
 Fixing Spring



WDA01E* - White
WDA01N* - Black
WDA01Y* - Rose Gold
WDA01Z* - Antique Bronze
 Rigid arm - 5.91" height

*order together with the part WDA00X or with the part WGA01

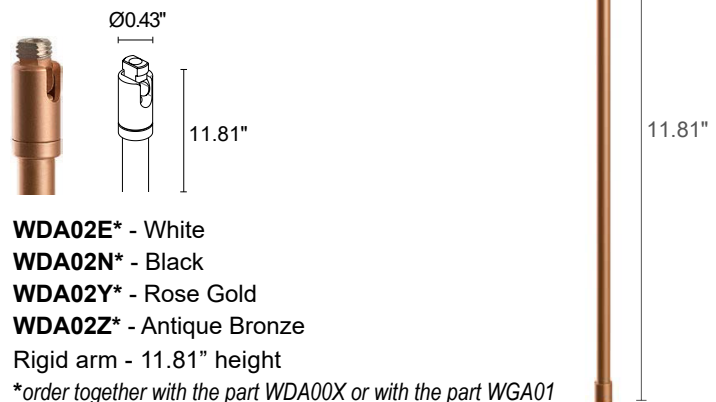

WDA02E* - White
WDA02N* - Black
WDA02Y* - Rose Gold
WDA02Z* - Antique Bronze
 Rigid arm - 11.81" height

*order together with the part WDA00X or with the part WGA01

Job Name/Date:

Fixture Type Designation:

PHOTOMETRIC DATA

Note all Photometry is 3000K

R1 – 18° (18° - 80°)

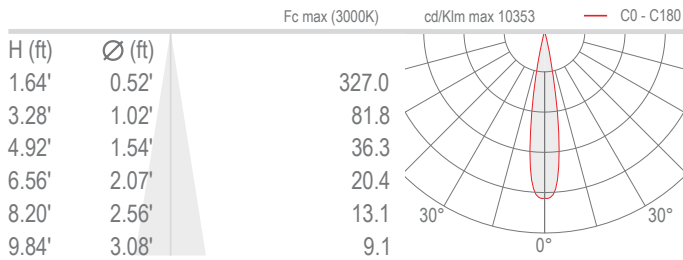

R1 – 80° (18° - 80°)

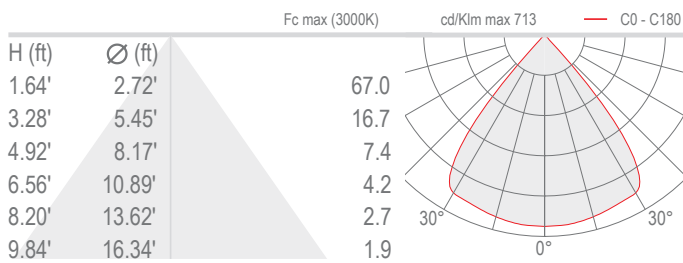

Job Name/Date:

Fixture Type Designation: