

The Litus 1 series features a sophisticated flush/trimless mount design and with 6 standard optic options are highly versatile for both general and more dynamic lighting. The square version can be used for downlight applications as well. **The Bright 1, Smoothy 1 and Litus 1 series all use the same LED.**

TECHNICAL DATA

Wattage / Input	2W (700mA)
Power Supply	Remote, not included. See page 2.
Construction	Body: Aluminum alloy EN AW 6082 Lens: Tempered, serigraphed-gray, and transparent extra-clear glass Cable Length: 4.92' standard
CCT	2700K, 3000K, 4000K
CRI	CRI >80, CRI >90
Delivered Lumens	188 lm (3000K, 22°, CRI 80) 165 lm (3000K, 22°, CRI 90)
Efficacy	94 lm/W (3000K, 22°, CRI 80) 83 lm/W (3000K, 22°, CRI 90)
Optics	6 Standard (see below) <i>The diffused light is made by an opal acrylic under the glass - no optic inside.</i>
Finishes	Glass
Fixture Dimensions	Ø1.89" x 2.48" h
Aperture	Ø1.89"
Fixture Weight	0.44 lbs
LED Source	1 Power LED
Lumen Maintenance	L90,B10>50,000hrs (Ta 25°C)
Color Consistency	1/4 ANSI BIN
Operating Temp.	-4°F to +113°F
IP Rating	IP67
IK Rating	IK08
Driveover	2205 lbs



Fixture Dimensions

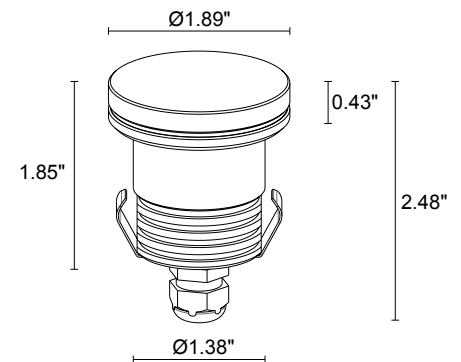

ORDERING INFORMATION

Example: **LT10100FLNV** or **LT10100FLNV-2**. Accessories / Power Supplies ordered separately.

LT1010				NV	
Model No.	CRI	CCT	Optics	Finish	Cable Length
LT1010	0 - 80 CRI 1 - 90 CRI	F - 2700K 5 - 3000K 9 - 4000K	S - 13° M - 22° F - 30° P - 35° sharp L - 48° D - Diffuse	NV - Glass	4.92' standard 1 - 16.40' 2 - 32.81' 3 - 49.21' 4 - 65.62'

Job Name/Date:

Fixture Type Designation:

SUGGESTED POWER SUPPLIES

700mA

Part Number	Description	Input/Output	# of Fixtures
PPLT00537	Non-Dim	120-277VAC to 700mA, 4W, Class 2	1-1
PPLT00466-P	0-10V Dimming to 1.0%	120-277VAC to 700mA, 10W, Class 2	1-3
PPLT00498	Phase Dim (120V Only)	120VAC to 700mA, 12W, Class 2	2-4
PPLT00465-P	0-10V Dimming to 1.0%	120-277VAC to 700mA, 20W, Class 2	1-10
PPLT00308-P	0-10V Dimming to 0.1%	120-277VAC to 700mA, 30W, Class 2	1-15
PPLT00480-P	0-10V Dimming to 1.0%	120-277VAC to 700mA, 30W, Class 2	1-15
PPLT00261	Leading/Trailing Edge Dimming to 10% (120V only)	120-277VAC to 700mA, 32W, Class 2	7-12

Suggested Lutron Compatible

Part Number	Option	Lutron SKU	Dim Range	Description	Input/Output	# of Fixtures
PPLT00512	LTEA2W	LTEA	100%-1%	Hi-Lume™ 1% 2-Wire LED Driver (120V forward phase only)	120VAC to 700mA, 14W, Class 2	3-5
PPLT00515	L3DAE / L3DA3W	L3DA	100%-1%	Hi-Lume™ 1% EcoSystem™ / 3-Wire LED Driver	120-277VAC to 700mA, 14W, Class 2	3-5
PPLT00278	LTEA2W	LTEA	100%-1%	Hi-Lume™ 1% 2-Wire LED Driver (120V forward phase only)	120VAC to 700mA, 27W, Class 2	6-10
PPLT00517	L3DAE / L3DA3W	L3DA	100%-1%	Hi-Lume™ 1% EcoSystem™ / 3-Wire LED Driver	120VAC to 700mA, 27W, Class 2	6-10
PPLT00510	LTEA2W	LTEA	100%-1%	Hi-Lume™ 1% 2-Wire LED Driver (120V forward phase only)	120VAC to 700mA, 38W, Class 2	11-15
PPLT00181	L3DAE / L3DA3W	L3DA	100%-1%	Hi-Lume™ 1% EcoSystem™ / 3-Wire LED Driver	120-277VAC to 700mA, 38W, Class 2	11-15

For other power supply options consult factory.

ACCESSORIES

Anti-Glare

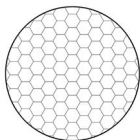

WH0100

Honeycomb Louvre
Not available for diffuse (D) or 35° sharp (P) optics

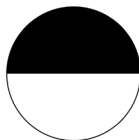

WE0600S

Anti-glare lens, half transparent and half serigraphed black
Can be fitted on all optics except 48° (L) optic

Installation

Ø1.97"



WC4010

Outer Casing *For in-grade use*



WL0100

Suction cup fixture removal tool

Job Name/Date:

Fixture Type Designation:

PHOTOMETRIC DATA

Note all Photometry is CRI 80, 3000K

S - 13° CRI 80

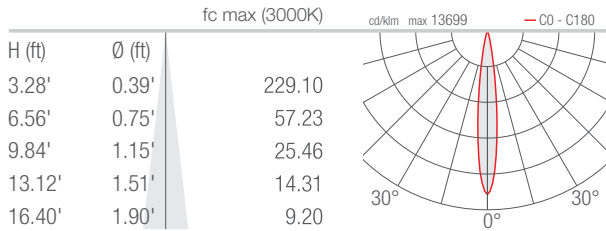

M - 22° CRI 80

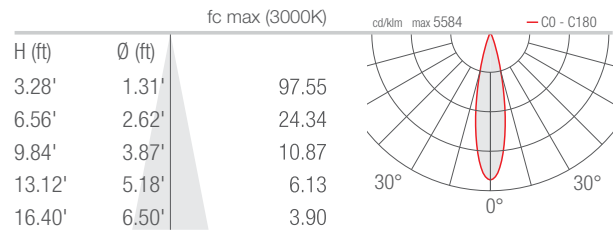

F - 30° CRI 80

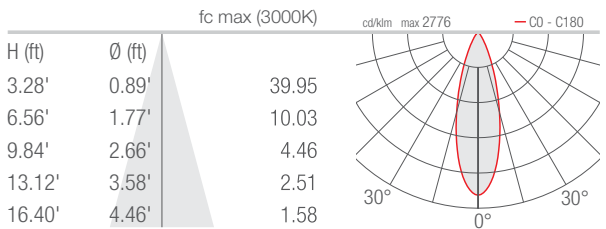

P - 35° sharp CRI 80

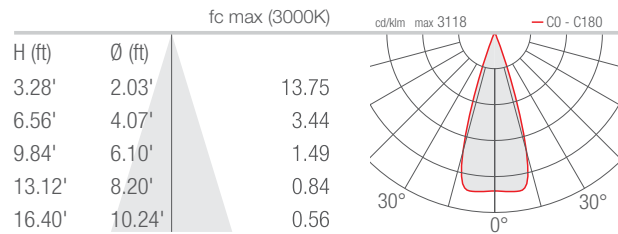

L - 48° CRI 80

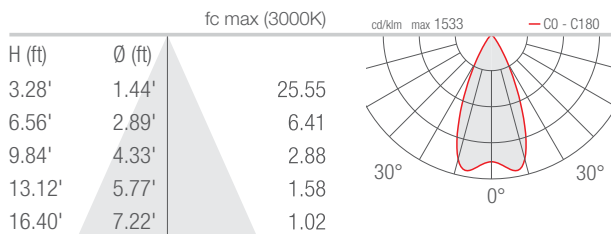

D - Diffuse CRI 80

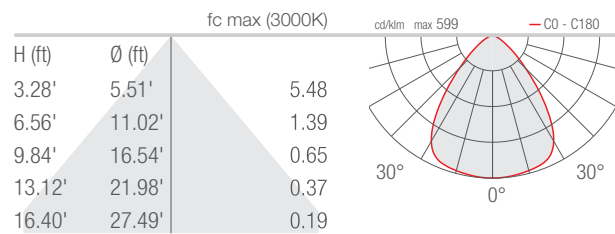

Job Name/Date:

Fixture Type Designation: