



The timeless Pixo range stands for ultimate minimalistic design. The fully paintable range of plaster fittings offers enhanced visual comfort due to a deep-set lamp source, and is ideal for energy efficient LED lamps. The truly trimless Pixo range blends perfectly with any interior. The Pixo range is available in a fixed (non-adjustable) version, in a fully adjustable version, in an IP44 version, and in a wall washer version. On top of this the Pixo 50 range exists in a double version (Pixo 2 x 50) for the ease of installation of twin lamps. This allows you to create a powerful, yet flexible universal design language.

## PIXO 30 IP20

INDOOR

Adjustable  $\odot$  0° - 10°

$\square$  4.49" x 5.28"

Material : CALCYT® plaster

### PIXO 30 LED 450LM CRI 97 INTEGRAL

REF N° 273 71 930 phase DIM CRI 97 2700°K

REF N° 273 71 830 phase DIM CRI 97 3000°K

6.5W - 450lm - 2 Step MacAdam  $\square$   
Standard beam angle 32° (options 40°, 50°)  
Parallel wiring - Connects directly to XXVAC  
h=3.86" -  $\square$  -  $\odot$

### PIXO 30 LED 600LM INTEGRAL

REF N° 273 71 530 phase DIM CRI 80 2200°K

REF N° 273 71 030 phase DIM CRI 90 2700°K

REF N° 273 71 130 phase DIM CRI 90 3000°K

6.5W - 600lm - 2 Step MacAdam  $\square$   
Standard beam angle 32° (options 24°, 40°, 50°)  
Parallel wiring - Connects directly to XXVAC  
h=3.86" -  $\square$  -  $\odot$

### PIXO 30 LED 200LM REAL SPOT INTEGRAL

REF N° 273 70 510 phase DIM CRI 80 2200°K

REF N° 273 70 010 phase DIM CRI 90 2700°K

REF N° 273 70 110 phase DIM CRI 90 3000°K

3W - 200lm - 3 Step MacAdam  $\square$   
5° beam angle -  $\square$  -  $\odot$   
Parallel wiring - Connects directly to XXVAC  
h=3.86"

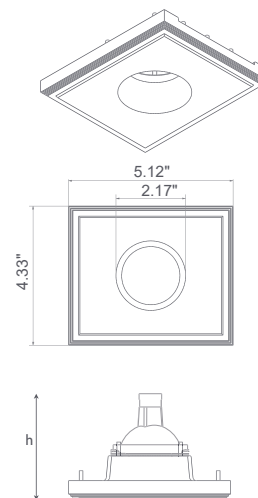

### INSTALLATION KIT

**STANDARD** (included) installation system for ceiling 0.35" - 0.47" - 0.59"

REF N° 273 99 025 installation system for gypsum ceiling 0.98"

REF N° 273 99 030 installation system for gypsum ceiling 1.18"

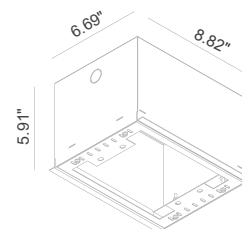

### BEAM ANGLES

**STANDARD** (included) beam angle 32°

REF N° 204 30 024 optional beam angle 24°

REF N° 204 30 040 optional beam angle 40°

REF N° 204 30 050 optional beam angle 50°



# PIXO 30 IP54

BATHROOM

Adjustable  $\odot$  0° - 10°

$\square$  4.49" x 5.28"

Material : CALCYT® plaster

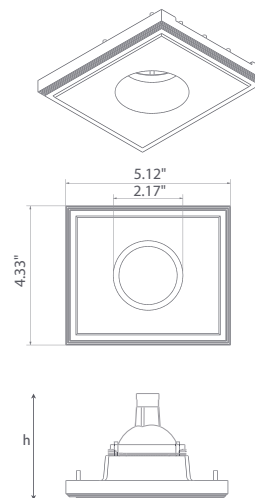

## PIXO 30 LED 450LM CRI 97 INTEGRAL

REF N° 273 71 931 phase DIM CRI 97 2700°K

REF N° 273 71 831 phase DIM CRI 97 3000°K

6.5W - 450lm - 2 Step MacAdam  $\square$  230V/50Hz  
Standard beam angle 32° (options 40°, 50°)  
Parallel wiring - Connects directly to XXVAC  
h=3.86" -  $\square$  -  $\odot$

## PIXO 30 LED 450LM CRI 97 REMOTE DRIVER

REF N° 273 29 931 excl. LED driver CRI 97 2700°K

REF N° 273 29 831 excl. LED driver CRI 97 3000°K

6.5W - 450lm - 2 Step MacAdam Standard  
beam angle 32° (options 40°, 50°) Serial  
wiring - Requires remote LED driver  
h=3.86" -  $\square$  -  $\odot$

## PIXO 30 LED 600LM INTEGRAL

REF N° 273 71 531 phase DIM CRI 80 2200°K

REF N° 273 71 031 phase DIM CRI 90 2700°K

REF N° 273 71 131 phase DIM CRI 90 3000°K

6.5W - 600lm - 2 Step MacAdam  $\square$  230V/50Hz  
Standard beam angle 32° (options 24°, 40°, 50°)  
Parallel wiring - Connects directly to XXVAC  
h=3.86" -  $\square$  -  $\odot$

## PIXO 30 LED 600LM REMOTE DRIVER

REF N° 273 29 531 excl. LED driver CRI 80 2200°K

REF N° 273 29 031 excl. LED driver CRI 90 2700°K

REF N° 273 29 131 excl. LED driver CRI 90 3000°K

6.5W - 600lm - 2 Step MacAdam  
Standard beam angle 32° (options 24°, 40°, 50°)  
Serial wiring - Requires remote LED driver  
h=3.86" -  $\square$  -  $\odot$

## INSTALLATION KIT

**STANDARD** (included) installation system for ceiling 0.35" - 0.47" - 0.59"

REF N° 273 99 025 installation system for gypsum ceiling 0.98"

REF N° 273 99 030 installation system for gypsum ceiling 1.18"

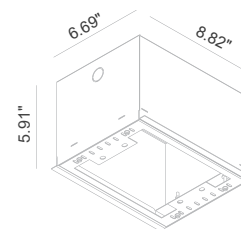

## BEAM ANGLES

**STANDARD** (included) beam angle 32°

REF N° 204 30 024 optional beam angle 24°

REF N° 204 30 040 optional beam angle 40°

REF N° 204 30 050 optional beam angle 50°



# PIXO 30 IP54

OUTDOOR

Adjustable  $\odot$  0° - 10°

$\square$  4.49" x 5.28"

Material : waterproof CALCYT+®

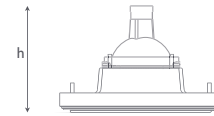
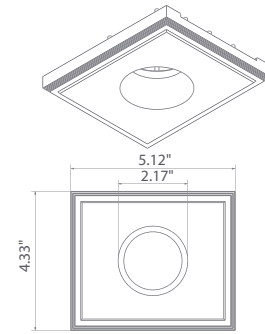

## INSTALLATION KIT

**STANDARD** (included) installation system for ceiling 0.35" - 0.47" - 0.59"

**REF N° 273 99 025** installation system for gypsum ceiling 0.98"

**REF N° 273 99 030** installation system for gypsum ceiling 1.18"

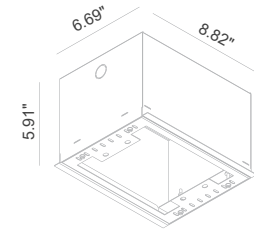

## BEAM ANGLES

**STANDARD** (included) beam angle 32°

**REF N° 204 30 024** optional beam angle 24°

**REF N° 204 30 040** optional beam angle 40°

**REF N° 204 30 050** optional beam angle 50°

### PIXO 30 LED 450LM CRI 97 INTEGRAL

**REF N° 273 71 935** phase DIM CRI 97 2700°K

**REF N° 273 71 835** phase DIM CRI 97 3000°K

6.5W - 450lm - 2 Step MacAdam  $\square$  230V/50Hz  
Standard beam angle 32° (options 40°, 50°)  
Parallel wiring - Connects directly to XXVAC  
h=3.86" -  $\square$  -  $\odot$

### PIXO 30 LED 450LM CRI 97 REMOTE DRIVER

**REF N° 273 29 935** excl. LED driver CRI 97 2700°K

**REF N° 273 29 835** excl. LED driver CRI 97 3000°K

6.5W - 450lm - 2 Step MacAdam Standard  
beam angle 32° (options 40°, 50°) Serial  
wiring - Requires remote LED driver  
h=3.86" -  $\square$  -  $\odot$

### PIXO 30 LED 600LM INTEGRAL

**REF N° 273 71 535** phase DIM CRI 80 2200°K

**REF N° 273 71 035** phase DIM CRI 90 2700°K

**REF N° 273 71 135** phase DIM CRI 90 3000°K

6.5W - 600lm - 2 Step MacAdam  $\square$  230V/50Hz  
Standard beam angle 32° (options 24°, 40°, 50°)  
Parallel wiring - Connects directly to XXVAC  
h=3.86" -  $\square$  -  $\odot$

### PIXO 30 LED 600LM REMOTE DRIVER

**REF N° 273 29 535** excl. LED driver CRI 80 2200°K

**REF N° 273 29 035** excl. LED driver CRI 90 2700°K

**REF N° 273 29 135** excl. LED driver CRI 90 3000°K

6.5W - 600lm - 2 Step MacAdam  
Standard beam angle 32° (options 24°, 40°, 50°)  
Serial wiring - Requires remote LED driver  
h=3.86" -  $\square$  -  $\odot$



# PIXO 50 FIX IP20

INDOOR

Fix (not adjustable) 0° - 0°

4.49" x 5.28"

Material : CALCYT® plaster

## PIXO 50 LED WARMDIM

WARMDIM : DIMS FROM 3000°K TO 2000°K

REF N°	500LM CRI80	900LM CRI90
phase DIM	227 72 640	227 73 640
DIM 0-10V	227 62 640	227 63 640

6W (500lm) - 12.8W (900lm) - 4 Step MacAdam  
 ☐ - 230V/50Hz -  - Incl. LED driver  
 (phase DIM, 0-10V) Standard beam angle  
 36° (options 24°) h = 4.53" (500lm) -  
 h = 5.91" (900lm)

## PIXO 50 LED 1300LM CRI 80

REF N°	2700°K	3000°K	4000°K
phase DIM	227 73 040	227 73 140	227 73 240
DIM 0-10V	227 63 040	227 63 140	227 63 240

Xicato LED - 11.7W - 1300lm - 2 Step MacAdam  
 ☐ - 230V/50Hz -  - Incl. LED driver  
 (phase DIM, 0-10V) Standard beam angle  
 36° (options 12°, 24°)  
 h = 5.91"

## PIXO 50 LED 700LM CRI 80

REF N°	2700°K	3000°K	4000°K
phase DIM	227 72 040	227 72 140	227 72 240
DIM 0-10V	227 62 040	227 62 140	227 62 240

Xicato LED - 5.6 W - 720lm - 2 Step MacAdam  
 ☐ - 230V/50Hz -  - Incl. LED driver  
 (phase DIM, 0-10V) Standard beam angle  
 36° (options 12°, 24°)  
 h = 3.62" (phase DIM models beam 36°)  
 h = 4.53" (all other models)

## PIXO 50 LED 700LM CRI 97

REF N°	2700°K	3000°K	4000°K
phase DIM	227 72 940	227 72 840	227 72 740
DIM 0-10V	227 62 940	227 62 840	227 62 740

Xicato LED - 7.4 W - 720lm - 2 Step MacAdam  
 ☐ - 230V/50Hz -  - Incl. LED driver  
 (phase DIM, 0-10V) Standard beam angle  
 36° (options 12°, 24°)  
 h = 4.53" (models beam angle 36°)  
 h = 5.91" (models beam angle 12° or 24°)

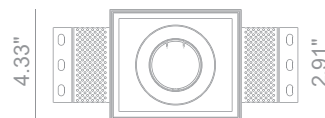
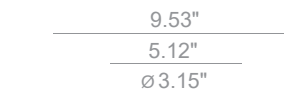
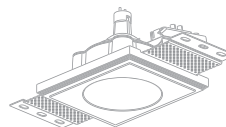

### INSTALLATION KIT

**STANDARD** (included) installation system for ceiling 0.35" - 0.47" - 0.59"

**REF N° 261 99 025** installation system for gypsum ceiling 0.98"

**REF N° 261 99 030** installation system for gypsum ceiling 1.18"

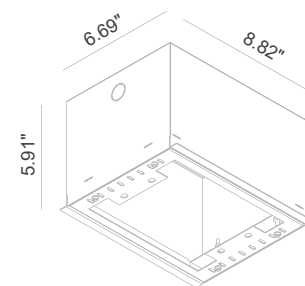

### BEAM ANGLES

**STANDARD** (included) beam angle 36°

**REF N° 205 50 012** optional beam angle 12°

**REF N° 205 50 024** optional beam angle 24°

### EMERGENCY UNITS

**REF N° 693 01 001** 1h basic + control LED

**REF N° 693 01 003** 3h basic + control LED





# PIXO 50 ADJUSTABLE IP20

INDOOR

Adjustable  $\odot$  0° - 30°

4.49" x 5.28"

Material : CALCYT® plaster

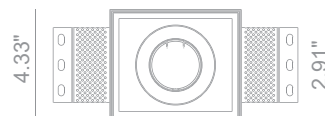
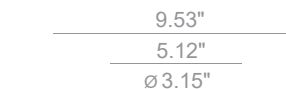
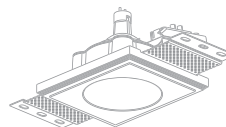

## INSTALLATION KIT

**STANDARD** (included) installation system for ceiling 0.35" - 0.47" - 0.59"

**REF N° 261 99 025** installation system for gypsum ceiling 0.98"

**REF N° 261 99 030** installation system for gypsum ceiling 1.18"

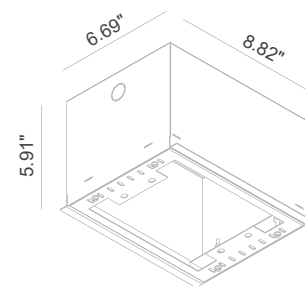

## BEAM ANGLES

**STANDARD** (included) beam angle 36°

**REF N° 205 50 012** optional beam angle 12°

**REF N° 205 50 024** optional beam angle 24°

## EMERGENCY UNITS

**REF N° 693 01 001** 1h basic + control LED

**REF N° 693 01 003** 3h basic + control LED

### PIXO 50 LED WARMDIM

WARMDIM : DIMS FROM 3000°K TO 2000°K

REF N°	500LM CRI80	900LM CRI90
phase DIM	261 72 640	261 73 640
DIM 0-10V	261 62 640	261 63 640

6W (500lm) - 12.8W (900lm) - 4 Step MacAdam  
 $\square$  - 230V/50Hz -  $\blacksquare$  - Incl. LED driver  
 (phase DIM, 0-10V) Standard beam angle  
 36° (options 24°)  
 h = 4.53" (500lm) - h = 5.91" (900lm)

### PIXO 50 LED 1300LM CRI 80

REF N°	2700°K	3000°K	4000°K
phase DIM	261 73 040	261 73 140	261 73 240
DIM 0-10V	261 63 040	261 63 140	261 63 240

Xicato LED - 11.7W - 1300lm - 2 Step MacAdam  
 $\square$  - 230V/50Hz -  $\blacksquare$  - Incl. LED driver  
 (phase DIM, 0-10V) Standard beam angle  
 36° (options 12°, 24°)  
 h = 5.91"

### PIXO 50 LED 700LM CRI 80

REF N°	2700°K	3000°K	4000°K
phase DIM	261 72 040	261 72 140	261 72 240
DIM 1-10V	261 62 040	261 62 140	261 62 240

Xicato LED - 5.6 W - 720lm - 2 Step MacAdam  
 $\square$  - 230V/50Hz -  $\blacksquare$  - Incl. LED driver  
 (phase DIM, 0-10V) Standard beam angle  
 36° (options 12°, 24°)  
 h = 3.62" (phase DIM models beam 36°) h  
 = 4.53" (all other models)

### PIXO 50 LED 700LM CRI 97

REF N°	2700°K	3000°K	4000°K
phase DIM	261 72 940	261 72 840	261 72 740
DIM 1-10V	261 62 940	261 62 840	261 62 740

Xicato LED - 7.4 W - 720lm - 2 Step MacAdam  
 $\square$  - 230V/50Hz -  $\blacksquare$  - Incl. LED driver  
 (phase DIM, 0-10V) Standard beam angle  
 36° (options 12°, 24°)  
 h = 4.53" (models beam angle 36°)  
 h = 5.91" (models beam angle 12° or 24°)

# PIXO 50 ADJUSTABLE IP20

## ACCESSORIES



**STANDARD** (included) LAMPHOLDER RING WHITE



**REF N° 201 10 002** LAMPHOLDER RING BLACK



**REF N° 201 11 001**  
EXTENSION S WHITE  
Ø 2.20" x 1.02" ⊕ 0° - 10°



**REF N° 201 12 001**  
EXTENSION M WHITE  
Ø 2.20" x 1.42" ⊕ 0° - 10°



**REF N° 201 13 001**  
EXTENSION L WHITE  
Ø 2.20" x 2.68" ⊕ 0° - 10°



**REF N° 201 11 002**  
EXTENSION S BLACK  
Ø 2.20 x 1.02" ⊕ 0° - 10°



**REF N° 201 12 002**  
EXTENSION M BLACK  
Ø 2.20" x 1.42" ⊕ 0° - 10°



**REF N° 201 13 002**  
EXTENSION L BLACK  
Ø 2.20" x 2.68" ⊕ 0° - 10°



**REF N° 201 51 001**  
FROSTED PLEXI WHITE  
Only for LED lampsources



**REF N° 201 52 001**  
HONEYCOMB WHITE  
Only for LED lampsources



**REF N° 201 53 001**  
SPHERICAL GLASS LENS  
IN WHITE RING



**REF N° 201 51 002**  
FROSTED PLEXI BLACK  
Only for LED lampsources



**REF N° 201 52 002**  
HONEYCOMB BLACK  
Only for LED lampsources



**REF N° 201 53 002**  
SPHERICAL GLASS LENS  
IN BLACK RING





# PIXO 50 IP54

BATHROOM

Fix (not adjustable) 0° - 0°

4.49" x 5.28"

Material : CALCYT® plaster

## PIXO 50 LED WARMDIM

WARMDIM : DIMS FROM 3000°K TO 2000°K

REF N°	500LM CRI80	900LM CRI90
phase DIM	261 72 641	261 73 641
DIM 0-10V	261 62 641	261 63 641

6W (500lm) - 12.8W (900lm) - 4 Step MacAdam  
 □ - 230V/50Hz - Incl. LED driver (phase DIM, 0-10V) Standard beam angle 36° (options 24°)  
 h = 4.53" (500lm) - h = 5.91" (900lm)

## PIXO 50 LED 1300LM CRI 80

REF N°	2700°K	3000°K	4000°K
phase DIM	261 73 041	261 73 141	261 73 241
DIM 0-10V	261 63 041	261 63 141	261 63 241

Xicato LED - 11.7W - 1300lm - 2 Step MacAdam  
 □ - 230V/50Hz - Incl. LED driver (phase DIM, 0-10V) Standard beam angle 36° (options 12°, 24°)  
 h = 5.91"

## PIXO 50 LED 700LM CRI 80

REF N°	2700°K	3000°K	4000°K
phase DIM	261 72 041	261 72 141	261 72 241
DIM 0-10V	261 62 041	261 62 141	261 62 241

Xicato LED - 5.6 W - 720lm - 2 Step MacAdam  
 □ - 230V/50Hz - Incl. LED driver (phase DIM, 0-10V) Standard beam angle 36° (options 12°, 24°)  
 h = 3.62" (phase DIM models beam 36°)  
 h = 4.53" (all other models)

## PIXO 50 LED 700LM CRI 97

REF N°	2700°K	3000°K	4000°K
phase DIM	261 72 941	261 72 841	261 72 741
DIM 0-10V	261 62 941	261 62 841	261 62 741

Xicato LED - 7.4 W - 720lm - 2 Step MacAdam  
 □ - 230V/50Hz - Incl. LED driver (phase DIM, 0-10V) Standard beam angle 36° (options 12°, 24°)  
 h = 4.53" (models beam angle 36°)  
 h = 5.91" (models beam angle 12° or 24°)

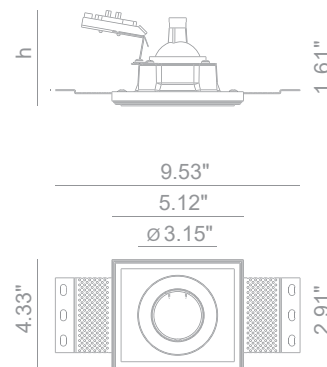
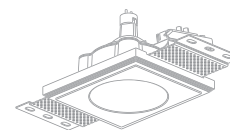

### INSTALLATION KIT

**STANDARD** (included) installation system for ceiling 0.35" - 0.47" - 0.59"

**REF N° 261 99 025** installation system for gypsum ceiling 0.98"

**REF N° 261 99 030** installation system for gypsum ceiling 1.18"

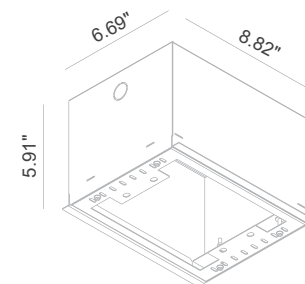

### BEAM ANGLES

**STANDARD** (included) beam angle 36°

**REF N° 205 50 012** optional beam angle 12°

**REF N° 205 50 024** optional beam angle 24°

### EMERGENCY UNITS

**REF N° 693 01 001** 1h basic + control LED

**REF N° 693 01 003** 3h basic + control LED



# PIXO 50 IP54

OUTDOOR

Fix (not adjustable) 0° - 0°

4.49" x 5.28"

Material : waterproof CALCYT+®

## PIXO 50 LED WARMDIM

WARMDIM : DIMS FROM 3000°K TO 2000°K

REF N°	500LM CRI80	900LM CRI90
phase DIM	261 72 645	261 73 645
DIM 0-10V	261 62 645	261 63 645

6W (500lm) - 12.8W (900lm) - 4 Step MacAdam  
 ☐ - 230V/50Hz -  - Incl. LED driver  
 (phase DIM, 0-10V) Standard beam angle  
 36° (options 24°)  
 h = 4.53" (500lm) - h = 5.91" (900lm)

## PIXO 50 LED 1300LM CRI 80

REF N°	2700°K	3000°K	4000°K
phase DIM	261 73 045	261 73 145	261 73 245
DIM 0-10V	261 63 045	261 63 145	261 63 245

Xicato LED - 11.7W - 1300lm - 2 Step MacAdam  
 ☐ - 230V/50Hz -  - Incl. LED driver  
 (phase DIM, 0-10V) Standard beam angle  
 36° (options 12°, 24°)  
 h = 5.91"

## PIXO 50 LED 700LM CRI 80

REF N°	2700°K	3000°K	4000°K
phase DIM	261 72 045	261 72 145	261 72 245
DIM 0-10V	261 62 045	261 62 145	261 62 245

Xicato LED - 5.6 W - 720lm - 2 Step MacAdam  
 ☐ - 230V/50Hz -  - Incl. LED driver  
 (phase DIM, 0-10V) Standard beam angle  
 36° (options 12°, 24°)  
 h = 3.62" (phase DIM models beam 36°)  
 h = 4.53" (all other models)

## PIXO 50 LED 700LM CRI 97

REF N°	2700°K	3000°K	4000°K
phase DIM	261 72 945	261 72 845	261 72 745
DIM 0-10V	261 62 945	261 62 845	261 62 745

Xicato LED - 7.4 W - 720lm - 2 Step MacAdam  
 ☐ - 230V/50Hz -  - Incl. LED driver  
 (phase DIM, 0-10V) Standard beam angle  
 36° (options 12°, 24°)  
 h = 4.53" (models beam angle 36°)  
 h = 5.91" (models beam angle 12° or 24°)

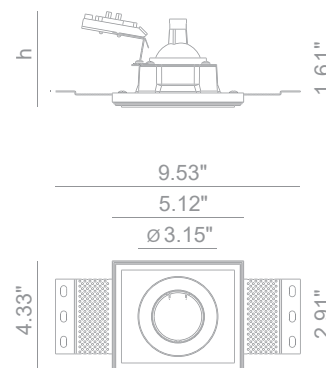
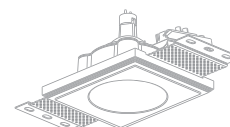

## INSTALLATION KIT

**STANDARD** (included) installation system for ceiling 0.35" - 0.47" - 0.59"

**REF N° 261 99 025** installation system for gypsum ceiling 0.98"

**REF N° 261 99 030** installation system for gypsum ceiling 1.18"

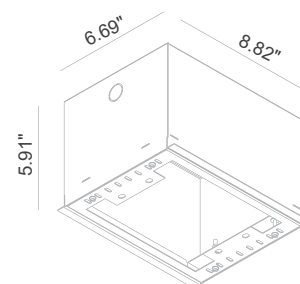

## BEAM ANGLES

**STANDARD** (included) beam angle 36°

**REF N° 205 50 012** optional beam angle 12°

**REF N° 205 50 024** optional beam angle 24°

## EMERGENCY UNITS

**REF N° 693 01 001** 1h basic + control LED

**REF N° 693 01 003** 3h basic + control LED





## PIXO R 50 IP20

INDOOR

Adjustable  $\odot$  0° - 30°

$\square$  Ø3.94"

Material : CALCYT® plaster

### PIXO R 50 LED 500LM CRI 80 REMOTE DRIVER WARMDIM

WARMDIM : DIMS FROM 3000°K TO 2000°K

REF N° 270 29 640

6 W - 500lm - 4 Step MacAdam  
 -  $\square$  - Excl. LED driver  
 Requires remote LED driver @ 350 mA  
 Standard beam angle 36° (options 24°)  
 h = 4.84"

### PIXO R 50 LED 700LM CRI 80 REMOTE DRIVER

REF N° 270 29 040 2700K

REF N° 270 29 140 3000K

REF N° 270 29 240 4000K

Xicato LED - 5.6W - 720lm - 2 Step MacAdam  
 -  $\square$  - Excl. LED driver  
 Requires remote LED driver @ 350 mA  
 Standard beam angle 36° (options 12°, 24°)  
 h = 4.84"

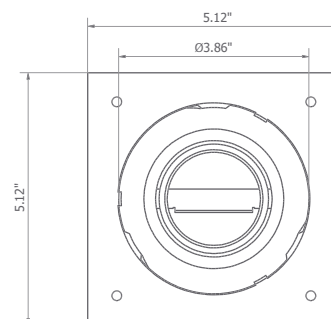
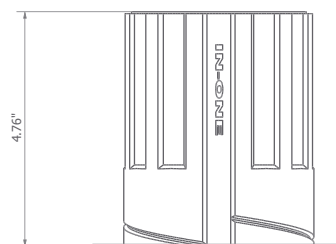
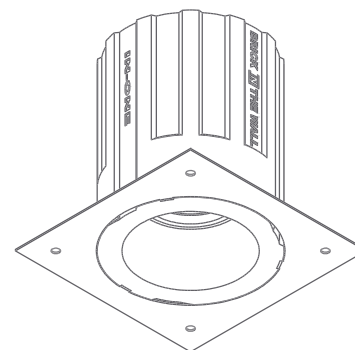

### INSTALLATION KIT

**STANDARD** (included) installation system for concrete ceiling  
 height adjustable

### BEAM ANGLES

**STANDARD** (included) beam angle 36°

REF N° 205 50 012 optional beam angle 12°

REF N° 205 50 024 optional beam angle 24°



## PIXO R 50 IP54

BATHROOM

Fix (not adjustable) 0° - 0°

☐ Ø3.94"

Material : CALCYT® plaster

### PIXO R 50 LED 500LM CRI 80 REMOTE DRIVER WARMDIM

WARMDIM : DIMS FROM 3000°K TO 2000°K

REF N° 270 29 641

6W - 500lm - 4 Step MacAdam

☐ - Excl. LED driver

Requires remote LED driver @ 350 mA

Standard beam angle 36° (options 24°)

h = 4.84"

### PIXO R 50 LED 700LM CRI 80 REMOTE DRIVER

REF N° 270 29 041 2700K

REF N° 270 29 141 3000K

REF N° 270 29 241 4000K

Xicato LED - 5,6W - 720lm - 2 Step MacAdam

☐ - Excl. LED driver

Requires remote LED driver @ 350 mA

Standard beam angle 36° (options 12°, 24°)

h = 4.84"

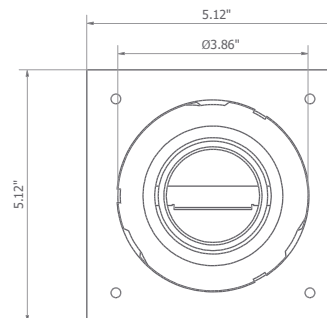
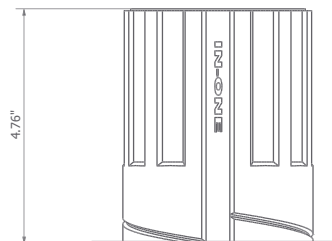
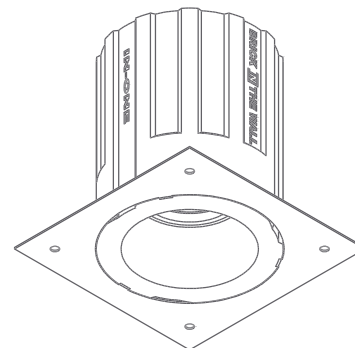

### INSTALLATION KIT

**STANDARD** (included) installation system for concrete ceiling  
height adjustable

### BEAM ANGLES

**STANDARD** (included) beam angle 36°

REF N° 205 50 012 optional beam angle 12°

REF N° 205 50 024 optional beam angle 24°



## PIXO R 50 IP54

OUTDOOR

Fix (not adjustable) 0° - 0°

□ ∅3.94"

Material : waterproof CALCYT+®

### PIXO R 50 LED 500LM CRI 80 REMOTE DRIVER WARMDIM

WARMDIM : DIMS FROM 3000°K TO 2000°K

REF N° 270 29 645

6W - 500lm - 4 Step MacAdam  
 -  - Excl. LED driver  
 Requires remote LED driver @ 350 mA  
 Standard beam angle 36° (options 24°)  
 h = 4.84"

### PIXO R 50 LED 700LM CRI 80 REMOTE DRIVER

REF N° 270 29 045 2700K

REF N° 270 29 145 3000K

REF N° 270 29 245 4000K

Xicato LED - 5,6W - 720lm - 2 Step MacAdam  
 -  - Excl. LED driver  
 Requires remote LED driver @ 350 mA  
 Standard beam angle 36° (options 12°, 24°)  
 h = 4.84"

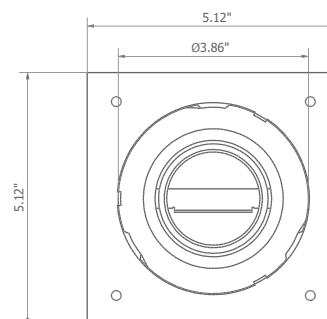
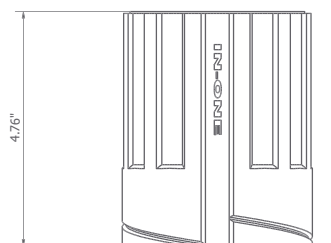
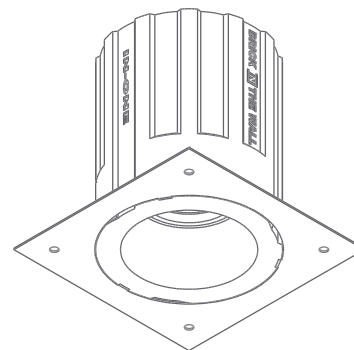

### INSTALLATION KIT

**STANDARD** (included) installation system for concrete ceiling  
 height adjustable

### BEAM ANGLES

**STANDARD** (included) beam angle 36°

REF N° 205 50 012 optional beam angle 12°

REF N° 205 50 024 optional beam angle 24°



## PIXO 50 W IP20

INDOOR

Fix (not adjustable) 0° - 0°

4.49" x 5.67"

Material : CALCYT® plaster

## PIXO 50 W LED WARMDIM

WARMDIM : DIMS FROM 3000°K TO 2000°K

REF N°	500LM CRI80	900LM CRI90
phase DIM	262 72 640	262 73 640
DIM 0-10V	262 62 640	262 63 640

6W (500lm) -12.8W (900lm) - 4 Step MacAdam  
 □ - 230V/50Hz -  - Incl. LED driver  
 (phase DIM, 0-10V) Standard beam angle  
 36° (options 24°)  
 h = 4.53" (500lm) - h = 5.91" (900lm)

PIXO 50 W LED  
1300LM CRI 80

REF N°	2700°K	3000°K	4000°K
phase DIM	262 73 040	262 73 140	262 73 240
DIM 0-10V	262 63 040	262 63 140	262 63 240

Xicato LED - 11.7W - 1300lm - 2 Step MacAdam  
 □ - 230V/50Hz -  - Incl. LED driver  
 (phase DIM, 0-10V) Standard beam angle  
 36° (options 12°, 24°)  
 h = 5.91"

PIXO 50 W LED  
700LM CRI 80

REF N°	2700°K	3000°K	4000°K
phase DIM	262 72 040	262 72 140	262 72 240
DIM 0-10V	262 62 040	262 62 140	262 62 240

Xicato LED - 5.6 W - 720lm - 2 Step MacAdam  
 □ - 230V/50Hz -  - Incl. LED driver  
 (phase DIM, 0-10V) Standard beam angle  
 36° (options 12°, 24°)  
 h = 3.62" (phase DIM models beam 36°)  
 h = 4.53" (all other models)

PIXO 50 W LED  
700LM CRI 97

REF N°	2700°K	3000°K	4000°K
phase DIM	262 72 940	262 72 840	262 72 740
DIM 0-10V	262 62 940	262 62 840	262 62 740

Xicato LED - 7.4 W - 720lm - 2 Step MacAdam  
 □ - 230V/50Hz -  - Incl. LED driver  
 (phase DIM, 0-10V) Standard beam angle  
 36° (options 12°, 24°)  
 h = 4.53" (models beam angle 36°)  
 h = 5.91" (models beam angle 12° or 24°)

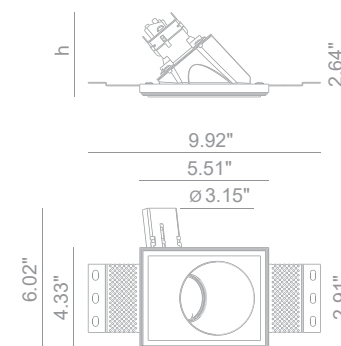
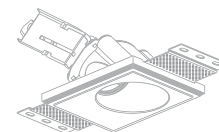

## INSTALLATION KIT

**STANDARD** (included) installation system for ceiling 0.35" - 0.47" - 0.59"

**REF N° 262 99 025** installation system for gypsum ceiling 0.98"

**REF N° 262 99 030** installation system for gypsum ceiling 1.18"

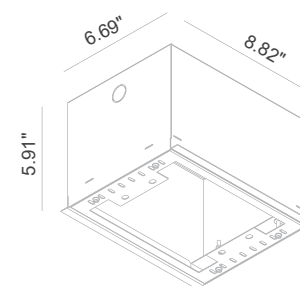

## BEAM ANGLES

**STANDARD** (included) beam angle 36°

**REF N° 205 50 012** optional beam angle 12°

**REF N° 205 50 024** optional beam angle 24°

## EMERGENCY UNITS

**REF N° 693 01 001** 1h basic + control LED

**REF N° 693 01 003** 3h basic + control LED





## PIXO 50 LOW IP20

INDOOR

Fix (not adjustable) 0° - 0°

4.49" x 5.28"

Material : CALCYT® plaster

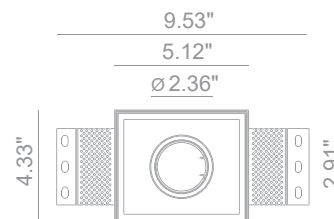
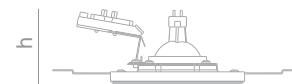

### INSTALLATION KIT

**STANDARD** (included) installation system for ceiling 0.35" - 0.47" - 0.59"

**REF N° 263 99 025** installation system for gypsum ceiling 0.98"

**REF N° 263 99 030** installation system for gypsum ceiling 1.18"

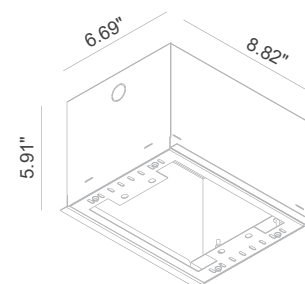

### BEAM ANGLES

**STANDARD** (included) beam angle 36°

**REF N° 205 50 012** optional beam angle 12°

**REF N° 205 50 024** optional beam angle 24°

### EMERGENCY UNITS

**REF N° 693 01 001** 1h basic + control LED

**REF N° 693 01 003** 3h basic + control LED

### PIXO 50 LOW LED 700LM CRI 80

REF N°	2700°K	3000°K	4000°K
phase DIM	263 72 040	263 72 140	263 72 240
DIM 0-10V	263 62 040	263 62 140	263 62 240

Xicato LED - 5.6 W - 720lm - 2 Step MacAdam

☐ - 230V/50Hz - ☑ - Incl. LED driver

(phase DIM, 0-10V) Standard beam angle 36° (options 12°, 24°)

h = 2.95" (phase DIM models beam 36°)

h = 3.74" (all other models)

### PIXO 50 LOW LED 700LM CRI 80 REMOTE DRIVER

**REF N° 263 29 040** 2700K

**REF N° 263 29 140** 3000K

**REF N° 263 29 240** 4000K

Xicato LED - 5.6W - 720lm - 2 Step MacAdam

☑ - Excl. LED driver

Requires remote LED driver @ 350 mA

Standard beam angle 60°

h = 1.97"



## PIXO 2X50 IP20

INDOOR

Adjustable  $\odot$  0° - 30° 4.49" x 9.61"

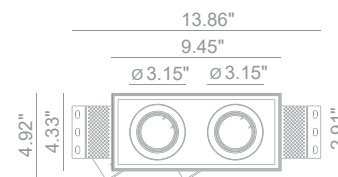
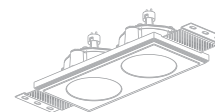

Material : CALCYT® plaster



## PIXO 2X50 LED WARMDIM



WARMDIM : DIMS FROM 3000°K TO 2000°K

REF N°	500LM CRI80
DIM 0-10V	257 62 640

2x 6 W - 2x 500lm - 4 Step MacAdam  
 - xx/50Hz -  - Incl. LED driver  
 (phase DIM, 0-10V) Standard beam angle  
 36° (options 24°)  
 h = 4.53"



PIXO 2X50 LED  
1300LM CRI 80

REF N°	2700°K	3000°K	4000°K
DIM 0-10V	257 27 040	257 27 140	257 27 240

2x Xicato LED - 2x 12.7 W - 2x 1300lm  
 - 700mA/50Hz -  - Incl. LED driver  
 (phase DIM, 0-10V) Standard  
 beam angle 36° (options 12°, 24°)  
 h = 5.91"



PIXO 2X50 LED  
700LM CRI 80

REF N°	2700°K	3000°K	4000°K
DIM 0-10V	257 62 040	257 62 140	257 62 240

2x Xicato LED - 2x 5.6 W - 2x 720lm  
 - xx/50Hz -  - Incl. LED driver  
 (phase DIM, 0-10V) Standard beam angle  
 36° (options 12°, 24°)  
 h = 3.62" (phase DIM models beam 36°)  
 h = 4.53" (all other models)

PIXO 2X50 LED  
700LM CRI 97

REF N°	2700°K	3000°K	4000°K
DIM 0-10V	257 62 940	257 62 840	257 62 740

2x Xicato LED - 2x 7.4 W - 2x 720lm  
 - xx/50Hz -  - Incl. LED driver  
 (phase DIM, 0-10V) Standard beam angle  
 36° (options 12°, 24°)  
 h = 4.53" (models beam angle 36°)  
 h = 5.91" (models beam angle 12° or 24°)

## INSTALLATION KIT

**STANDARD** (included) installation system for ceiling 0.35" - 0.47" - 0.59"

**REF N° 257 99 025** installation system for gypsum ceiling 0.98"

**REF N° 257 99 030** installation system for gypsum ceiling 1.18"

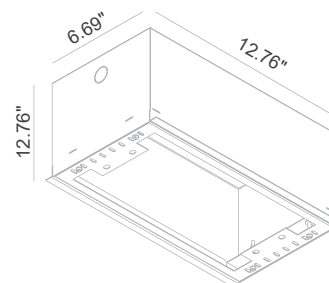

## BEAM ANGLES

**STANDARD** (included) beam angle 36°

**REF N° 205 50 012** optional beam angle 12°

**REF N° 205 50 024** optional beam angle 24°

## EMERGENCY UNITS

**REF N° 693 01 001** 1h basic + control LED

**REF N° 693 01 003** 3h basic + control LED

# PIXO 2X50 IP20

## ACCESSORIES



**STANDARD** (included) 2 x LAMPHOLDER RING WHITE



**REF N° 201 10 022** 2 x LAMPHOLDER RING BLACK



**REF N° 201 11 001**  
1 x EXTENSION S WHITE  
Ø 2.20" x 1.02" ⌀ 0° - 10°



**REF N° 201 12 001**  
1 x EXTENSION M WHITE  
Ø 2.20" x 1.42" ⌀ 0° - 10°



**REF N° 201 13 001**  
1 x EXTENSION L WHITE  
Ø 2.20" x 2.68" ⌀ 0° - 10°



**REF N° 201 11 002**  
1 x EXTENSION S BLACK  
Ø 2.20" x 1.02" ⌀ 0° - 10°



**REF N° 201 12 002**  
1 x EXTENSION M BLACK  
Ø 2.20" x 1.42" ⌀ 0° - 10°



**REF N° 201 13 002**  
1 x EXTENSION L BLACK  
Ø 2.20" x 2.68" ⌀ 0° - 10°



**REF N° 201 51 001**  
1 x FROSTED PLEXI WHITE  
Only for LED lampsources



**REF N° 201 52 001**  
1 x HONEYCOMB WHITE  
Only for LED lampsources



**REF N° 201 53 001**  
1 x SPHERICAL GLASS LENS  
IN WHITE RING



**REF N° 201 51 002**  
1 x FROSTED PLEXI BLACK  
Only for LED lampsources



**REF N° 201 52 002**  
1 x HONEYCOMB BLACK  
Only for LED lampsources



**REF N° 201 53 002**  
1 x SPHERICAL GLASS LENS  
IN BLACK RING

# PIXO 2X50 IP54

## BATHROOM

Fix (not adjustable) 0° - 0°

4.49" x 9.61"

Material : CALCYT® plaster

### PIXO 2X50 LED WARMDIM

WARMDIM : DIMS FROM 3000°K TO 2000°K

REF N°	500LM CRI80
DIM 0-10V	257 62 641

2x 6 W - 2x 500lm - 4 Step MacAdam  
 ☐ - xx/50Hz - - Incl. LED driver  
 (phase DIM, 0-10V) Standard beam angle  
 36° (options 24°)  
 h = 4.53"

### PIXO 2X50 LED 1300LM CRI 80

REF N°	2700°K	3000°K	4000°K
DIM 0-10V	257 27 041	257 27 141	257 27 241

2x Xicato LED - 2x 12.7W - 2x 1300lm  
 ☐ - 700mA/50Hz - - Incl. LED  
 driver (phase DIM, 0-10V) Standard beam  
 angle 36° (options 12°, 24°)  
 h = 5.91"

### PIXO 2X50 LED 700LM CRI 80

REF N°	2700°K	3000°K	4000°K
DIM 1-10V	257 62 041	257 62 141	257 62 241

2x Xicato LED - 2x 5.6W - 2x 720lm  
 ☐ - xx/50Hz - - Incl. LED driver  
 (phase DIM, 0-10V) Standard beam angle  
 36° (options 12°, 24°)  
 h = 3.62" (phase DIM models beam 36°)  
 h = 4.53" (all other models)

### PIXO 2X50 LED 700LM CRI 97

REF N°	2700°K	3000°K	4000°K
DIM 1-10V	257 62 941	257 62 841	257 62 741

2x Xicato LED - 2x 7.4W - 2x 720lm  
 ☐ - xx/50Hz - - Incl. LED driver  
 (phase DIM, 0-10V) Standard beam angle  
 36° (options 12°, 24°)  
 h = 4.53" (models beam angle 36°)  
 h = 5.91" (models beam angle 12° or 24°)

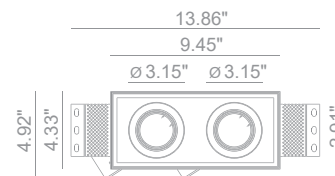
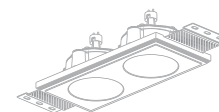

### INSTALLATION KIT

**STANDARD** (included) installation system for ceiling 0.35" - 0.47" - 0.59"

**REF N° 257 99 025** installation system for gypsum ceiling 0.98"

**REF N° 257 99 030** installation system for gypsum ceiling 1.18"

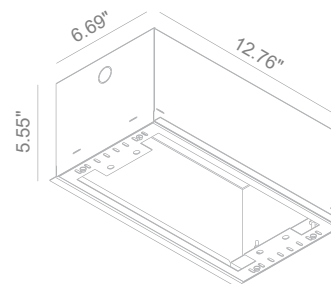

### BEAM ANGLES

**STANDARD** (included) beam angle 36°

**REF N° 205 50 012** optional beam angle 12°

**REF N° 205 50 024** optional beam angle 24°

### EMERGENCY UNITS

**REF N° 693 01 001** 1h basic + control LED

**REF N° 693 01 003** 3h basic + control LED

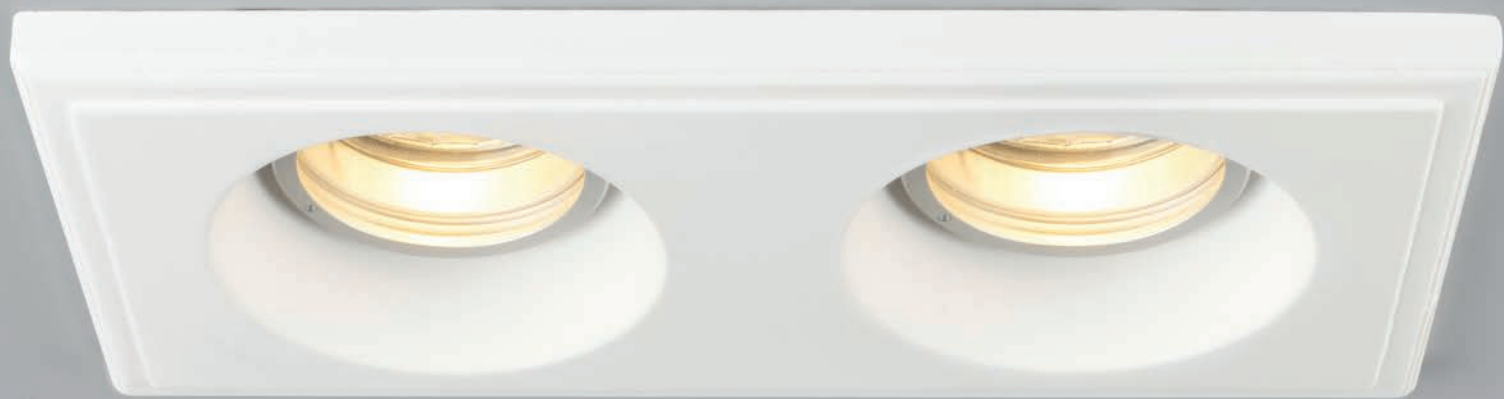

# PIXO 2X50 IP54

OUTDOOR

Fix (not adjustable) 0° - 0°

4.49" x 9.61"

Material : waterproof CALCYT+®

## PIXO 2X50 LED WARMDIM

WARMDIM : DIMS FROM 3000°K TO 2000°K

REF N°	500LM CRI80
DIM 0-10V	257 62 645

2x 6 W - 2x 500lm - 4 Step MacAdam  
 ☐ - xx/50Hz - ☐ - Incl. LED driver  
 (phase DIM, 0-10V) Standard beam angle  
 36° (options 24°)  
 h = 4.53"

## PIXO 2X50 LED 1300LM CRI 80

REF N°	2700°K	3000°K	4000°K
DIM 0-10V	257 27 045	257 27 145	257 27 245

2x Xicato LED - 2x 12.7W - 2x 1300lm  
 ☐ - 700mA/50Hz - ☐ - Incl. LED  
 driver (phase DIM, 0-10V) Standard beam  
 angle 36° (options 12°, 24°)  
 h = 5.91"

## PIXO 2X50 LED 700LM CRI 80

REF N°	2700°K	3000°K	4000°K
DIM 0-10V	257 62 045	257 62 145	257 62 245

2x Xicato LED - 2x 5.6 W - 2x 720lm  
 ☐ - xx/50Hz - ☐ - Incl. LED driver  
 (phase DIM, 0-10V) Standard beam angle  
 36° (options 12°, 24°)  
 h = 3.62" (phase DIM models beam 36°)  
 h = 4.53" (all other models)

## PIXO 2X50 LED 700LM CRI 97

REF N°	2700°K	3000°K	4000°K
DIM 0-10V	257 62 945	257 62 845	257 62 745

2x Xicato LED - 2x 7.4 W - 2x 720lm  
 ☐ - xx/50Hz - ☐ - Incl. LED driver  
 (phase DIM, 0-10V) Standard beam angle  
 36° (options 12°, 24°)  
 h = 4.53" (models beam angle 36°)  
 h = 5.91" (models beam angle 12° or 24°)

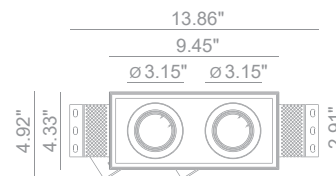
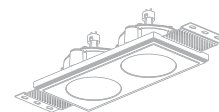

## INSTALLATION KIT

**STANDARD** (included) installation system for ceiling 0.35" - 0.47" - 0.59"

**REF N° 257 99 025** installation system for gypsum ceiling 0.98"

**REF N° 257 99 030** installation system for gypsum ceiling 1.18"

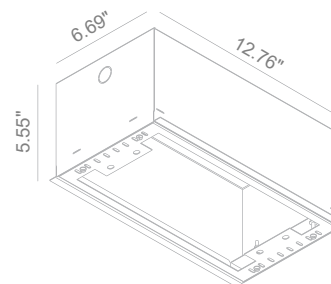

## BEAM ANGLES

**STANDARD** (included) beam angle 36°

**REF N° 205 50 012** optional beam angle 12°

**REF N° 205 50 024** optional beam angle 24°

## EMERGENCY UNITS

**REF N° 693 01 001** 1h basic + control LED

**REF N° 693 01 003** 3h basic + control LED





# PIXO 111 IP20

INDOOR

Adjustable  $\odot$  0° - 30°

$\square$  7.36" x 8.03"

Material : CALCYT® plaster

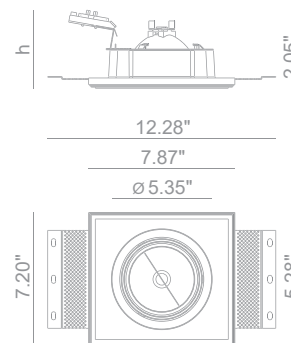
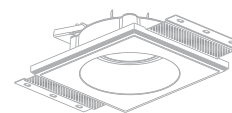

## INSTALLATION KIT

**STANDARD** (included) installation system for ceiling 0.35" - 0.47" - 0.59"

**REF N° 228 99 025** installation system for gypsum ceiling 0.98"

**REF N° 228 99 030** installation system for gypsum ceiling 1.18"

### PIXO 111 LED 3000LM CRI 80

REF N°	2700°K	3000°K	4000°K
on/off	228 26 040	228 26 140	228 26 240
phase DIM	228 75 040	228 75 140	228 75 240
DIM 0-10V	228 66 040	228 66 140	228 66 240

Xicato LED - 29.3W - 3000lm - 2 Step MacAdam  
 $\square$  - xxVAC/50Hz -  $\odot$  - Beam angle 36°  
 (option 20°) - Incl LED driver  
 h = 6.02"

### PIXO 111 LED 2000LM CRI 80

REF N°	2700°K	3000°K	4000°K
on/off	228 25 040	228 25 140	228 25 240
phase DIM	228 75 040	228 75 140	228 75 240
DIM 0-10V	228 65 040	228 65 140	228 65 240

Xicato LED - 19.5W - 2000lm - 2 Step MacAdam  
 $\square$  - xxVAC/50Hz -  $\odot$  - Beam 36°  
 (option 20°) - Incl LED driver  
 h = 6.02"

### PIXO 111 LED 1300LM CRI 97

REF N°	2700°K	3000°K	4000°K
on/off	228 23 940	228 23 840	228 23 740
phase DIM	228 73 940	228 73 840	228 73 740
DIM 0-10V	228 63 940	228 63 840	228 63 740

Xicato LED - 17.6W - 1300lm - 2 Step MacAdam  
 $\square$  - xxVAC/50Hz -  $\odot$  - Beam angle 36°  
 (option 20°) - Incl LED driver  
 h = 6.02"

### PIXO 111 LED 2000LM CRI 97

REF N°	2700°K	3000°K	4000°K
on/off	228 25 940	228 25 840	228 25 740
phase DIM	228 75 940	228 75 840	228 75 740
DIM 0-10V	228 65 940	228 65 840	228 65 740

Xicato LED - 22.3W - 2000lm - 2 Step MacAdam  
 $\square$  - xxVAC/50Hz -  $\odot$  - Beam angle 36°  
 (option 20°) - Incl LED driver  
 h = 6.02"

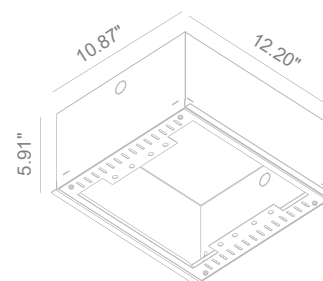

## BEAM ANGLES & OPTIONS

**STANDARD** (included) beam angle 36°

**REF N° 205 11 020** optional beam angle 20°

**REF N° 201 00 060** Frosted diffuser for 111 LED series

## EMERGENCY UNITS

**REF N° 693 01 001** 1h basic + control LED

**REF N° 693 01 003** 3h basic + control LED















