

Technical features

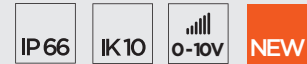

101604P

QUBO MAXI COB





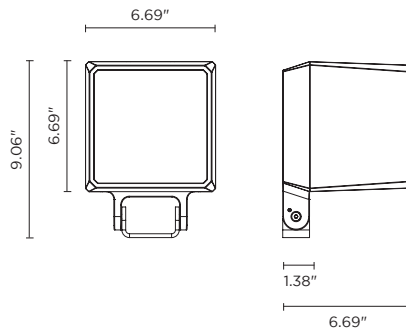

Designed by
NAVA + AROSIO

Floodlight for outdoor installation on a façade/wall, with U shape fixing bracket allowing vertical adjustment of +90° / -40°. Phospho-chromatized and polyester powder coated die-cast copper-free aluminum base and head, tempered safety glass, molded silicone gaskets, with screws in stainless steel. Built-in LED driver, with 1 COB CREE "CXB 2540" LED. IP66 rating.



Technical data

Wattage	42 WATT
IP Rating	IP66
IK Rating	IK10
Material	High corrosion resistance die-cast copper-free aluminum body
Coating	Polyester powder coating with phosphochromating pre-finish
Light source	1 x COB CREE "CXB 2540" LED
Screws	Stainless steel
Transformer	Electrical power supply 120VAC 50/60Hz built-in
Gasket	Silicone rubber
Glass	Tempered
Power cable	3.28' power cable included
Gross weight	9.92 lbs

light source	light beam options	lumen output (lm)	lumin. efficacy (lm/w)
3000°K warm-white			
cob led	 14°	4,950	117.85
cob led	 35°	4,752	113.14
cob led	 55°	4,560	108.57
4000°K neutral-white			
cob led	 14°	5,265	125.36
cob led	 35°	5,000	119.05
cob led	 55°	4,770	113.57

Finish color options:

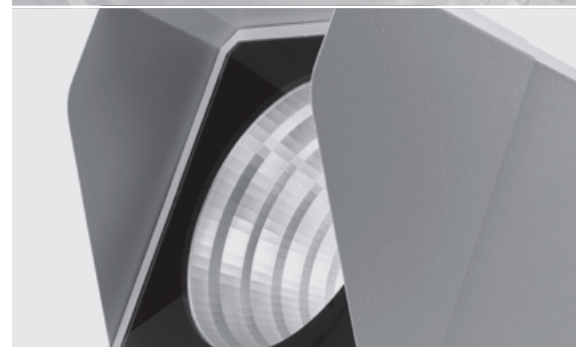

OTHER VIEW



OPTIONAL

AC044
SPIKE



AC074
HONEYCOMB LOUVER

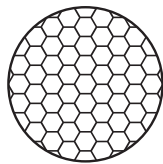

AC078
ANTI-GLARE VISOR



AC038
TREE STRAP



OPTIONAL

LUMINAIRE SUIVABLE
FOR POLE MOUNTING
IN SINGLE OR MULTIPLE
COMBINATIONS

