

Technical features



101601P

# QUBO MICRO HP





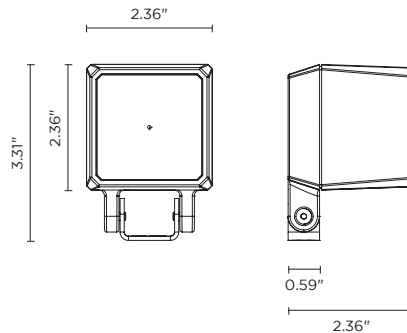

Designed by  
NAVA + AROSIO

Floodlight for outdoor installation on a façade/wall, with U shape fixing bracket allowing vertical adjustment of +90° / -40°. Phospho-chromatized and polyester powder coated die-cast copper-free aluminum base and head, tempered safety glass, molded silicone gaskets, with screws in stainless steel. Remote 24VDC power supply needed, with 1 x CREE "XHP35" LED. IP66 rating.



Technical data

Wattage	6 WATT
IP Rating	IP66
IK Rating	IK10
Material	High corrosion resistance die-cast copper-free aluminum body
Coating	Polyester powder coating with phosphochromating pre-finish
Light source	1 x CREE "XHP35" LED
Screws	Stainless steel
Remote driver	Constant voltage 24VDC
Gasket	Silicone rubber
Glass	Tempered
Power cable	3.28' power cable included
Gross weight	1.54 lbs

light source	light beam options	lumen output (lm)	lumin. efficacy (lm/w)
<b>3000°K warm-white</b>			
high-power led	 4°	510	85.00
high-power led	 10°	489	81.50
high-power led	 28°	474	79.00
<b>4000°K neutral-white</b>			
high-power led	 4°	520	86.67
high-power led	 10°	499	83.17
high-power led	 28°	484	80.67

Finish color options:

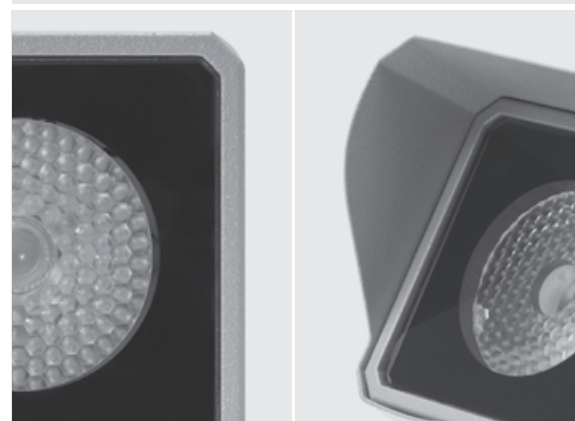

## OTHER VIEW

---



## OPTIONAL

---

AC044  
SPIKE



AC071  
HONEYCOMB LOUVER

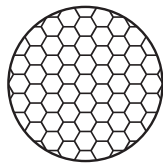

AC075  
ANTI-GLARE VISOR



AC038  
TREE STRAP

