

RIVER WALL 2.1

River Wall is an outdoor linear profile surface-mounted fixture for installation on walls, ceilings or floors using a bracket. It is available in white, blue or RGBW with a variety of optics options. River Wall 2.1 is available in static white or blue with wall washer optics.



TECHNICAL DATA

Wattage / Input	40W (120VAC)
Power Supply	Integral
Construction	Body: Anodized Aluminum Alloy EN AW 6060 Lens: Tempered, Transparent Glass Cable Length: 4.92'
CCT	2700K, 3000K, 4000K, 5000K, Blue
CRI	>80
Delivered Lumens	2098 lm (3000K)
Efficacy	52.5 lm/W (3000K)
Optics	Wall Washer
Finishes	Gray, Custom RAL
Fixture Dimensions	40.16" l x 2.17" w x 2.91" h LED Spacing: 1.97"
Fixture Weight	11.46 lbs
LED Source	20 Power LEDs
Lumen Maintenance	L80 >50,000hrs (Ta 25°C)
Color Consistency	3-Step MacAdam
Operating Temp.	-4°F to +113°F
IP Rating	IP66
IK Rating	IK09

Fixture Dimensions

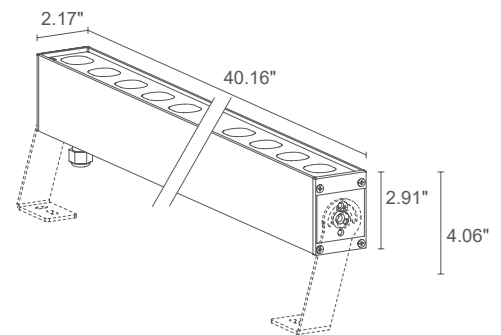

**REQUIRED BRACKETS,
ORDER SEPARATELY.**

ORDERING INFORMATION

Example: RW21105V1F. Accessories ordered separately.

RW2110		V1	
Model No.	CCT	Optics	Finish
RW2110	F - 2700K 5 - 3000K 9 - 4000K 0 - 5000K 1 - Blue	V1 - Wall Washer	F - Gray C - Custom RAL (consult factory for "C")

Job Name/Date:

Fixture Type Designation:

ACCESSORIES

Required for Installation



WM0811

Pair of brackets
4.92"



WM0812

Pair of brackets
10.83"

PHOTOMETRIC DATA

Note all Photometry is 3000K

V1 - Wall Washer

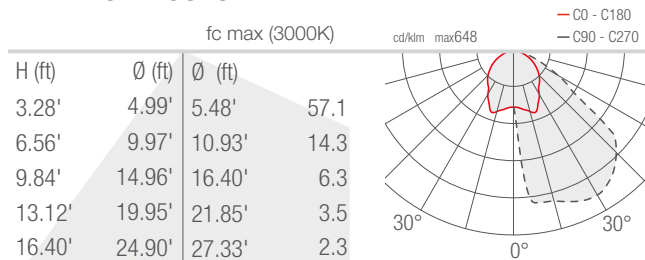

Job Name/Date:

Fixture Type Designation: