

SIRI 3.0
23W, gray



designplan™ 

79 Trenton Avenue
Frenchtown, NJ 08825

www.designplan.com

Tel: (908) 996-7710
Fax: (908) 996-7042



SIRI

OUTDOOR PROJECTORS
ARCHITECTURAL LIGHTING FOR LARGE BUILDINGS

2700K 3000K 4000K 5000K



ultra-narrow narrow medium wide elliptical



SIRI 1.0
9W 24VDC



SIRI 2.0
16W 24VDC



SIRI 3.0
23W 24VDC



SIRI 1.1
9W 24VDC



SIRI 2.1
16W 24VDC



SIRI 3.1
23W 24VDC



RGBW



narrow medium wide elliptical



SIRI 1.2
11W 24VDC



SIRI 2.2
20W 24VDC



SIRI 3.2
33W 24VDC



SIRI 1.3
11W 24VDC



SIRI 2.3
20W 24VDC



SIRI 3.3
33W 24VDC

RGBW
VERSION



**BUILT-IN
PROTECTION
SYSTEMS:**

**IPS
INTELLIGENT
PROTECTION
SYSTEM**



**PID
PROTECTIVE
IMPEDANCE DEVICE
(WHITE LED COLOR)**



**NTC
TEMPERATURE
SENSOR
BUILT IN
(SIRI 3.0 / 3.1)**



**DESIGN
patent
pending**



**6-STEP MATERIAL PROTECTION,
AND OXIDATION AND
CORROSION RESISTANCE**

Low-copper-content aluminum alloy EN AB 47100
Preparation for painting with ALODINE NT-E® coating
Epoxy paint
Polyester paint
Paints compliant with
Qualicoat automotive coating standard
Salt spray tested (over 1000 hours)



**SUITABLE
FOR OUTDOOR
APPLICATIONS**



**RAL FINISH
ON REQUEST**

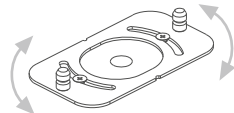

**INTEGRATED BASE FOR CONNECTIONS,
AND PLATE ADJUSTABLE THROUGH 35°**





SIRI

UNIQUE SELLING POINTS

IK07
SIRI 1

IK06
SIRI 2/3

BODY IN DIE-CAST
LOW-COPPER-CONTENT
ALUMINUM EN AB 47100
FOR EXCELLENT RESISTANCE
TO CORROSION



6° OPTICS

The 6° optics means the beam can be concentrated on a small area even at large distances



ANTI-GLARE RECESSED OPTICS



0.16"-THICK TRANSPARENT EXTRA-CLEAR
GLASS WITH VITRIFIED SERIGRAPHY,
HIGH TRANSMITTANCE TO ENSURE
CHROMATIC UNIFORMITY AND TEMPERED
FOR EXCELLENT RESISTANCE
TO KNOCKS AND SCRATCHES

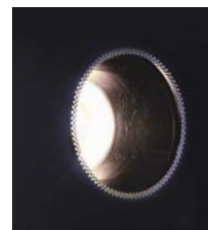

SCALED, ADJUSTABLE BRACKET



SIRI 1



SIRI 1.0



SIRI 1.1

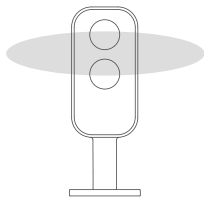

10°x45° optics

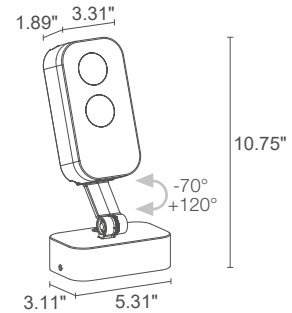
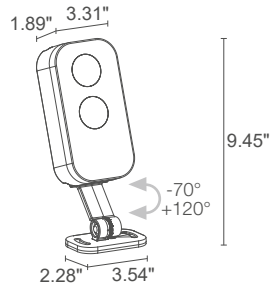

2.3 lbs IP66 IK07

3.0 lbs IP66 IK07

POWER / POWER SUPPLY MODEL NO.	9W 24VDC SR1010 E - White SR1010 F - Gray SR1010 H - Anthracite SR1010 T - Cor-ten
LED COLOR	F - 2700K 5 - 3000K 9 - 4000K 0 - 5000K
OPTICS	V - 6° S - 12° M - 30° L - 40° W - 10°x45°
POWER CABLES	includes 4.92' neoprene cable H05RN-F 0.12"x0.04" Ø0.28" 1 - 16.40' 2 - 32.81' 3 - 49.21' 4 - 65.62'
LUMEN OUTPUT AT SOURCE	603 lm (3000K)
DELIVERED LUMEN OUTPUT	422 lm (3000K, 30°)
NO. AND TYPE OF LED	2 power LEDs 1/4 ANSI BIN, 50,000h L95 B10 (Ta 25°C)
MATERIAL	body in die-cast aluminum lens in serigraphed, tempered, transparent extra-clear glass
POWER SUPPLY UNIT	remote power supply required, not included
MOUNTING	surface mounted (ceiling, wall, ground, spike)
ACCESSORIES	see accessories page

POWER / POWER SUPPLY MODEL NO.	9W 24VDC SR1110 E White SR1110 F Gray SR1110 H Anthracite SR1110 T Cor-ten
LED COLOR	F - 2700K 5 - 3000K 9 - 4000K 0 - 5000K
OPTICS	V - 6° S - 12° M - 30° L - 40° W - 10°x45°
POWER CABLES	includes 4.92' neoprene cable H05RN-F 0.12"x0.04" Ø0.28"
LUMEN OUTPUT AT SOURCE	603 lm (3000K)
DELIVERED LUMEN OUTPUT	422 lm (3000K, 30°)
NO. AND TYPE OF LED	2 power LEDs 1/4 ANSI BIN, 50,000h L95 B10 (Ta 25°C)
MATERIAL	body in die-cast aluminum lens in serigraphed, tempered, transparent extra-clear glass
POWER SUPPLY UNIT	remote power supply required, not included
MOUNTING	surface mounted (ceiling, wall, ground)
ACCESSORIES	see accessories page

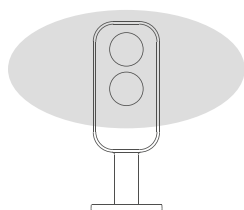

30°x60° optics



SIRI 1.2



SIRI 1.3

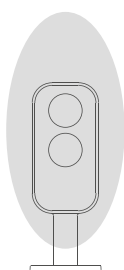

60°x30° optics

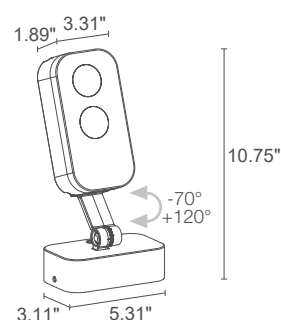
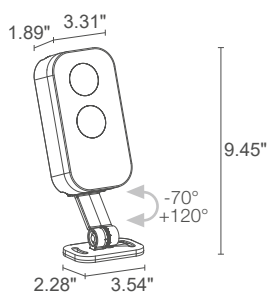

IPS LED 1.7 lbs IP66 IK07

IPS LED 2.5 lbs IP66 IK07

POWER / POWER SUPPLY MODEL NO.	11W 24VDC SR1200 7 ■ E White SR1200 7 ■ F Gray SR1200 7 ■ H Anthracite SR1200 7 ■ T Cor-ten
OPTICS	S - 21° M - 32° L - 58° W - 30°x60° X - 60°x30°
LED COLOUR	RGBW
LUMEN OUTPUT AT SOURCE	536 lm, R: 83 lm G: 150 lm B: 60 lm W: 243 lm (4000K)
DELIVERED LUMEN OUTPUT	379 lm, R: 59 lm G: 105 lm B: 42 lm W: 173 lm (4000K, 32°)
NO. AND TYPE OF LED	2 RGBW LED groups 50,000h L90 B10 (Ta 25°C)
MATERIAL	body in die-cast aluminum lens in serigraphed, tempered, transparent extra-clear glass
POWER SUPPLY UNIT	remote power supply required, not included
POWER CABLES	includes 4.92' FEP+RUB cable (equivalent to H05RN-F) 0.24"x0.02"/0.02" Ø0.25"
MOUNTING	surface mounted (ceiling, wall, ground, spike)
ACCESSORIES	see accessories page

POWER / POWER SUPPLY MODEL NO.	11W 24VDC SR1300 7 ■ E White SR1300 7 ■ F Gray SR1300 7 ■ H Anthracite SR1300 7 ■ T Cor-ten
OPTICS	S - 21° M - 32° L - 58° W - 30°x60° X - 60°x30°
LED COLOUR	RGBW
LUMEN OUTPUT AT SOURCE	536 lm, R: 83 lm G: 150 lm B: 60 lm W: 243 lm (4000K)
DELIVERED LUMEN OUTPUT	379 lm, R: 59 lm G: 105 lm B: 42 lm W: 173 lm (4000K, 32°)
NO. AND TYPE OF LED	2 RGBW LED groups 50,000h L90 B10 (Ta 25°C)
MATERIAL	body in die-cast aluminum lens in serigraphed, tempered, transparent extra-clear glass
POWER SUPPLY UNIT	remote power supply required, not included
POWER CABLES	includes 4.92' FEP+RUB cable (equivalent to H05RN-F) 0.24"x0.02"/0.02" Ø0.25"
MOUNTING	surface mounted (ceiling, wall, ground)
ACCESSORIES	see accessories page

SIRI 2



SIRI 2.0



SIRI 2.1

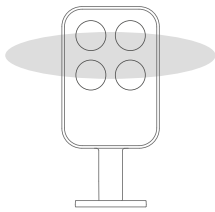

10°x45° optics

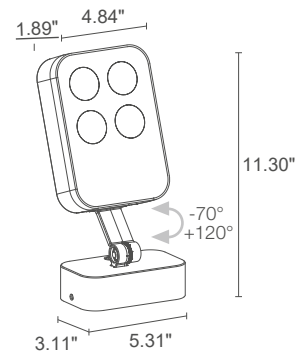
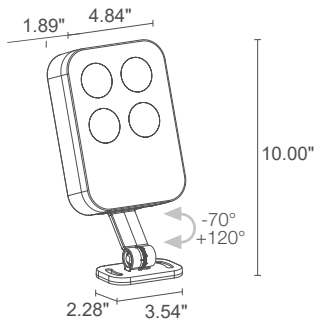

IPS PID LED TECH 3.1 lbs IP66 IK06

IPS PID LED TECH 4.3 lbs IP66 IK06

POWER / POWER SUPPLY MODEL NO.	16W 24VDC SR2010 ■ ■ ■ E - ■ ■ White SR2010 ■ ■ ■ F - ■ ■ Gray SR2010 ■ ■ ■ H - ■ ■ Anthracite SR2010 ■ ■ ■ T - ■ ■ Cor-ten
LED COLOR	F - 2700K 5 - 3000K 9 - 4000K 0 - 5000K
OPTICS	V - 6° S - 12° M - 30° L - 40° W - 10°x45°
POWER CABLES	includes 4.92' neoprene cable H05RN-F 0.12"x0.04" Ø0.28" 1 - 16.40' 2 - 32.81' 3 - 49.21' 4 - 65.62'
LUMEN OUTPUT AT SOURCE	1311 lm (3000K)
DELIVERED LUMEN OUTPUT	925 lm (3000K, 30°)
NO. AND TYPE OF LED	4 power LEDs 1/4 ANSI BIN, 50,000h L95 B10 (Ta 25°C)
MATERIAL	body in die-cast aluminum lens in serigraphed, tempered, transparent extra-clear glass
POWER SUPPLY UNIT	remote power supply required, not included
MOUNTING	surface mounted (ceiling, wall, ground, spike)
ACCESSORIES	see accessories page

POWER / POWER SUPPLY MODEL NO.	16W 24VDC SR2110 ■ ■ ■ E White SR2110 ■ ■ ■ F Gray SR2110 ■ ■ ■ H Anthracite SR2110 ■ ■ ■ T Cor-ten
LED COLOR	F - 2700K 5 - 3000K 9 - 4000K 0 - 5000K
OPTICS	V - 6° S - 12° M - 30° L - 40° W - 10°x45°
POWER CABLES	includes 4.92' neoprene cable H05RN-F 0.12"x0.04" Ø0.28"
LUMEN OUTPUT AT SOURCE	1311 lm (3000K)
DELIVERED LUMEN OUTPUT	925 lm (3000K, 30°)
NO. AND TYPE OF LED	4 power LEDs 1/4 ANSI BIN, 50,000h L95 B10 (Ta 25°C)
MATERIAL	body in die-cast aluminum lens in serigraphed, tempered, transparent extra-clear glass
POWER SUPPLY UNIT	remote power supply required, not included
MOUNTING	surface mounted (ceiling, wall, ground)
ACCESSORIES	see accessories page

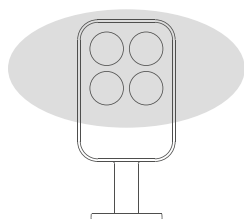

30°x60° optics



SIRI 2.2



SIRI 2.3

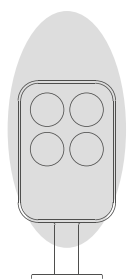

60°x30° optics

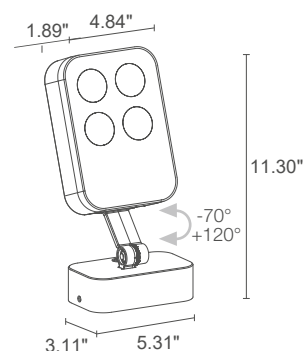
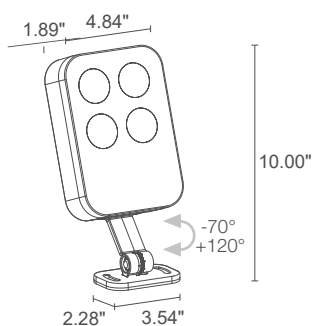

IPS LED TECH 3.1 lbs IP66 IK06

IPS LED TECH 4.2 lbs IP66 IK06

POWER / POWER SUPPLY MODEL NO.	20W 24VDC SR2200 7 ■ E White SR2200 7 ■ F Gray SR2200 7 ■ H Anthracite SR2200 7 ■ T Cor-ten
OPTICS	S - 21° M - 32° L - 58° W - 30°x60° X - 60°x30°
LED COLOR	RGBW
LUMEN OUTPUT AT SOURCE	1059 lm, R: 165 lm G: 293 lm B: 118 lm W: 483 lm (4000K)
DELIVERED LUMEN OUTPUT	756 lm, R: 118 lm G: 209 lm B: 84 lm W: 345 lm (4000K, 32°)
NO. AND TYPE OF LED	4 RGBW LED groups 50,000h L90 B10 (Ta 25°C)
MATERIAL	body in die-cast aluminum lens in serigraphed, tempered, transparent extra-clear glass
POWER SUPPLY UNIT	remote power supply required, not included
POWER CABLES	includes 4.92' FEP+RUB cable (equivalent to H05RN-F) 0.24"x0.02"/0.02" Ø0.25"
MOUNTING	surface mounted (ceiling, wall, ground, spike)
ACCESSORIES	see accessories page

POWER / POWER SUPPLY MODEL NO.	20W 24VDC SR2300 7 ■ E White SR2300 7 ■ F Gray SR2300 7 ■ H Anthracite SR2300 7 ■ T Cor-ten
OPTICS	S - 21° M - 32° L - 58° W - 30°x60° X - 60°x30°
LED COLOR	RGBW
LUMEN OUTPUT AT SOURCE	1059 lm, R: 165 lm G: 293 lm B: 118 lm W: 483 lm (4000K)
DELIVERED LUMEN OUTPUT	756 lm, R: 118 lm G: 209 lm B: 84 lm W: 345 lm (4000K, 32°)
NO. AND TYPE OF LED	4 RGBW LED groups 50,000h L90 B10 (Ta 25°C)
MATERIAL	body in die-cast aluminum lens in serigraphed, tempered, transparent extra-clear glass
POWER SUPPLY UNIT	remote power supply required, not included
POWER CABLES	includes 4.92' FEP+RUB cable (equivalent to H05RN-F) 0.24"x0.02"/0.02" Ø0.25"
MOUNTING	surface mounted (ceiling, wall, ground)
ACCESSORIES	see accessories page

SIRI 3



SIRI 3.0



SIRI 3.1

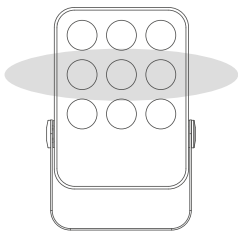

10°x45° optics

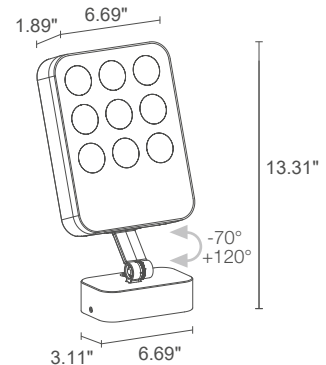
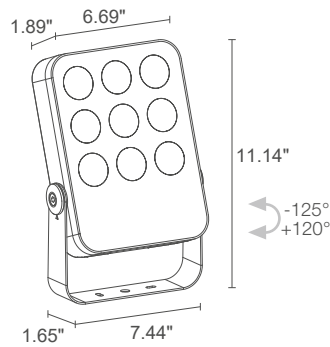

IPS PID NTC LED TECH 4.9 lbs IP66 IK06

IPS PID NTC LED TECH 5.4 lbs IP66 IK06

POWER / POWER SUPPLY	23W 24VDC
MODEL NO.	SR3010 ■ ■ ■ E - ■ ■ White SR3010 ■ ■ ■ F - ■ ■ Gray SR3010 ■ ■ ■ H - ■ ■ Anthracite SR3010 ■ ■ ■ T - ■ ■ Cor-ten

POWER / POWER SUPPLY	23W 24VDC
MODEL NO.	SR3110 ■ ■ ■ E White SR3110 ■ ■ ■ F Gray SR3110 ■ ■ ■ H Anthracite SR3110 ■ ■ ■ T Cor-ten

LED COLOR	F - 2700K 5 - 3000K 9 - 4000K 0 - 5000K
OPTICS	V - 6° S - 12° M - 30° L - 40° W - 10°x45°
POWER CABLES	includes 4.92' neoprene cable H05RN-F 0.12"x0.04" Ø0.28" 1 - 16.40' 2 - 32.81' 3 - 49.21' 4 - 65.62'

LED COLOR	F - 2700K 5 - 3000K 9 - 4000K 0 - 5000K
OPTICS	V - 6° S - 12° M - 30° L - 40° W - 10°x45°

LUMEN OUTPUT AT SOURCE	2214 lm (3000K)
DELIVERED LUMEN OUTPUT	1491 lm (3000K, 30°)
NO. AND TYPE OF LED	9 power LEDs 1/4 ANSI BIN, 50,000h L95 B10 (Ta 25°C)
MATERIAL	body in die-cast aluminum lens in serigraphed, tempered, transparent extra-clear glass
POWER SUPPLY UNIT	remote power supply required, not included
MOUNTING	surface mounted (ceiling, wall, ground, spike)
ACCESSORIES	see accessories page

LUMEN OUTPUT AT SOURCE	2214 lm (3000K)
DELIVERED LUMEN OUTPUT	1491 lm (3000K, 30°)
NO. AND TYPE OF LED	9 power LEDs 1/4 ANSI BIN, 50,000h L95 B10 (Ta 25°C)
MATERIAL	body in die-cast aluminum lens in serigraphed, tempered, transparent extra-clear glass
POWER SUPPLY UNIT	remote power supply required, not included
MOUNTING	surface mounted (ceiling, wall, ground)
ACCESSORIES	see accessories page

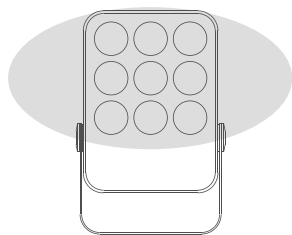

30°x60° optics



SIRI 3.2



SIRI 3.3

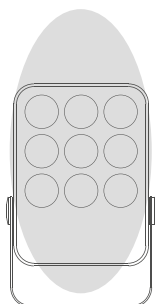

60°x30° optics

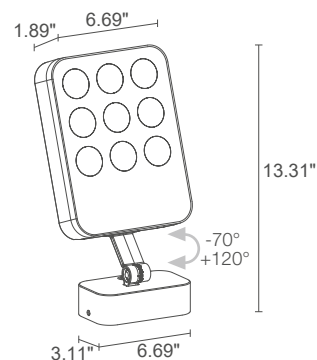
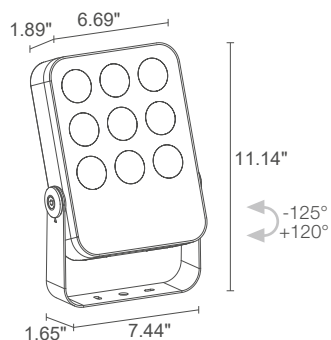

IPS LED 4.5 lbs IP66 IK06



IPS LED 5.3 lbs IP66 IK06

POWER / POWER SUPPLY MODEL NO.	33W 24VDC SR3200 7 ■ E White SR3200 7 ■ F Gray SR3200 7 ■ H Anthracite SR3200 7 ■ T Cor-ten
OPTICS	S - 21° M - 32° L - 58° W - 30°x60° X - 60°x30°
LED COLOR	RGBW
LUMEN OUTPUT AT SOURCE	2148 lm, R: 336 lm G: 594 lm B: 238 lm W: 980 lm (4000K)
DELIVERED LUMEN OUTPUT	1532 lm, R: 240 lm G: 423 lm B: 170 lm W: 699 lm (4000K, 32°)
NO. AND TYPE OF LED	9 RGBW LED groups 50,000h L90 B10 (Ta 25°C)
MATERIAL	body in die-cast aluminum lens in serigraphed, tempered, transparent extra-clear glass
POWER SUPPLY UNIT	remote power supply required, not included
POWER CABLES	includes 4.92' FEP+RUB cable (equivalent to H05RN-F) 0.24"x0.02"/0.02" Ø0.25"
MOUNTING	surface mounted (ceiling, wall, ground, spike)
ACCESSORIES	see accessories page

POWER / POWER SUPPLY MODEL NO.	33W 24VDC SR3300 7 ■ E White SR3300 7 ■ F Gray SR3300 7 ■ H Anthracite SR3300 7 ■ T Cor-ten
OPTICS	S - 21° M - 32° L - 58° W - 30°x60° X - 60°x30°
LED COLOR	RGBW
LUMEN OUTPUT AT SOURCE	2148 lm, R: 336 lm G: 594 lm B: 238 lm W: 980 lm (4000K)
DELIVERED LUMEN OUTPUT	1532 lm, R: 240 lm G: 423 lm B: 170 lm W: 699 lm (4000K, 32°)
NO. AND TYPE OF LED	9 RGBW LED groups 50,000h L90 B10 (Ta 25°C)
MATERIAL	body in die-cast aluminum lens in serigraphed, tempered, transparent extra-clear glass
POWER SUPPLY UNIT	remote power supply required, not included
POWER CABLES	includes 4.92' FEP+RUB cable (equivalent to H05RN-F) 0.24"x0.02"/0.02" Ø0.25"
MOUNTING	surface mounted (ceiling, wall, ground)
ACCESSORIES	none

SIRI

ACCESSORIES

	SIRI 1.0	SIRI 1.1	SIRI 1.2	SIRI 1.3	SIRI 2.0	SIRI 2.1	SIRI 2.2	SIRI 2.3	SIRI 3.0	SIRI 3.1	SIRI 3.2
ANTI-GLARE ACCESSORIES  Honeycomb louvre built into the lighting fixture order together with the lighting fixture the honeycomb louvre can be fitted on all optics, except for the 6° optics	WH5010	WH5010			WH5020	WH5020			WH5030	WH5030	
 Anti-glare hood the anti-glare hood is available on request in the same finish as the lighting fixture	WB5010H Anthracite	WB5010H Anthracite	WB5010H Anthracite	WB5010H Anthracite	WB5020H Anthracite	WB5020H Anthracite	WB5020H Anthracite	WB5020H Anthracite	WB5030H Anthracite		WB5030H Anthracite
	3.50"x3.54" h 6.81"	3.50"x3.54" h 6.81"	3.50"x3.54" h 6.81"	3.50"x3.54" h 6.81"	5.00"x3.54" h 7.36"	5.00"x3.54" h 7.36"	5.00"x3.54" h 7.36"	5.00"x3.54" h 7.36"	6.85"x3.98" h 7.48"		6.85"x3.98" h 7.48"
ACCESSORIES FOR INSTALLATION  Spike for in-ground installation	WP0300		WP0300		WP0300		WP0300		WP0300		WP0300

POWER CABLES Siri 1.0 / 2.0 / 3.0

the choice of power cable is included in the configuration of the code for the lighting fixture

- 1 16.40'
- 2 32.81'
- 3 49.21'
- 4 65.62'

Neoprene cables
H05RN-F 0.12"x0.04" Ø0.28" IPS

SIRI 3.0

3000K, 23W, 30°, white

Project by / Corinne Vezzoni & Associés

Light planning by / 8'18"

thecamp, Aix-en-Provence, France



SIRI

OUTDOOR PROJECTORS

SIRI 1.0 1.1

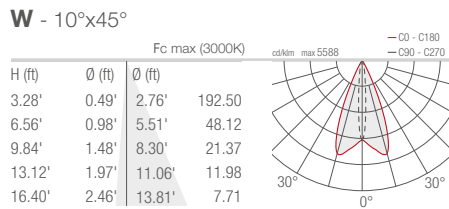
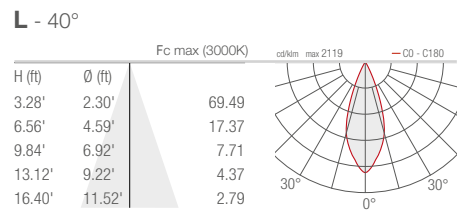
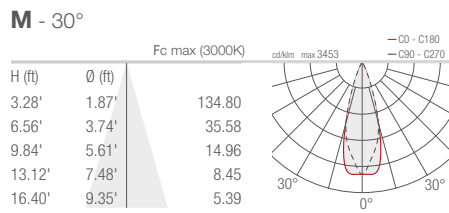
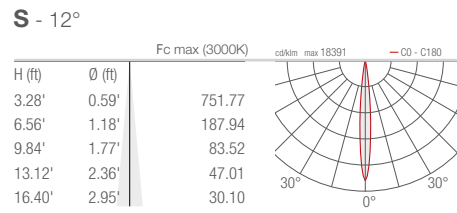
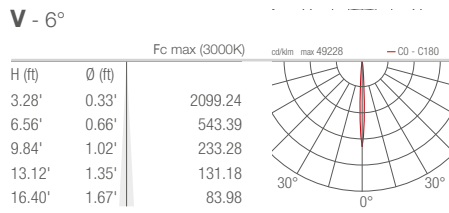

SIRI 1.2 1.3

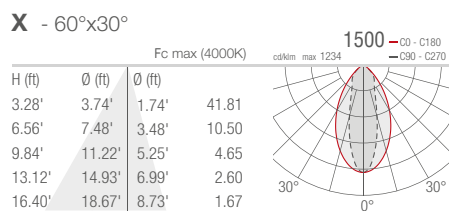
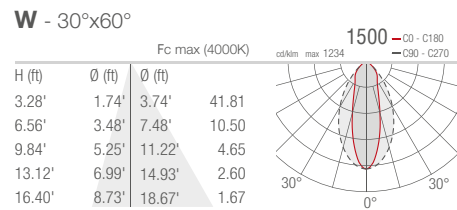
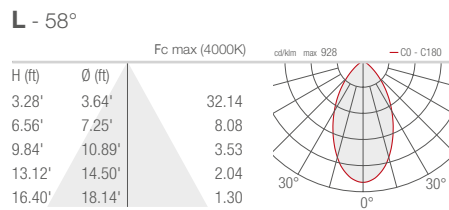
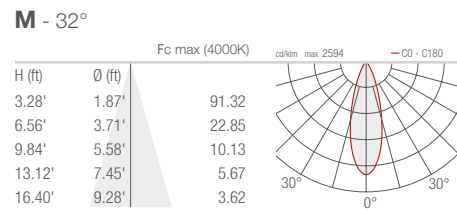
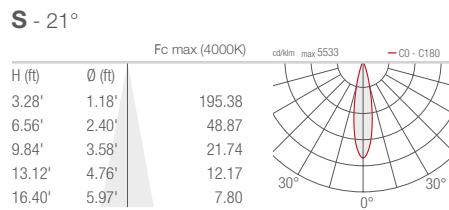



SIRI 2.0 2.1

V - 6°

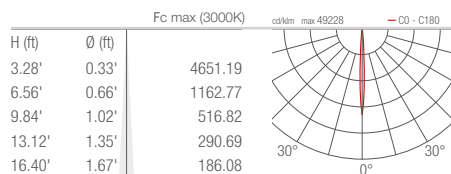

S - 12°

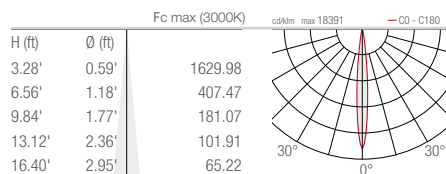

M - 30°

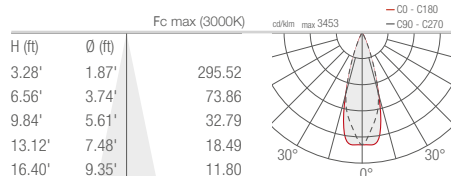

L - 40°

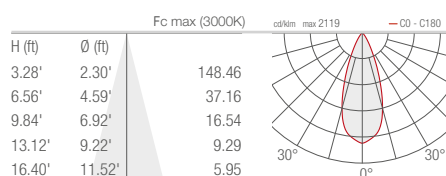

W - 10°x45°

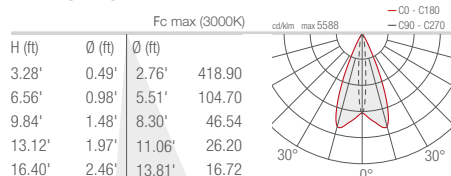

SIRI 2.2 2.3

S - 21°

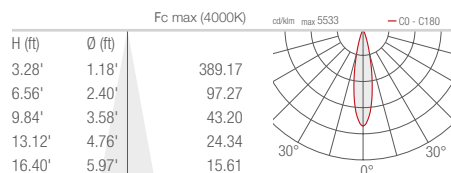

M - 32°

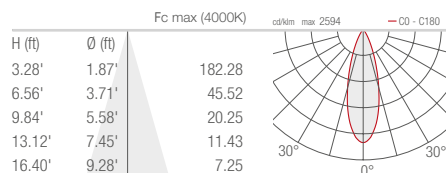

L - 58°

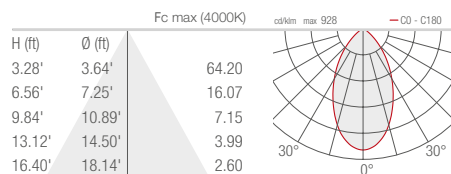

W - 30°x60°

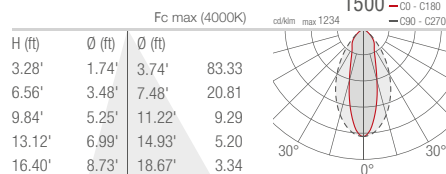

X - 60°x30°

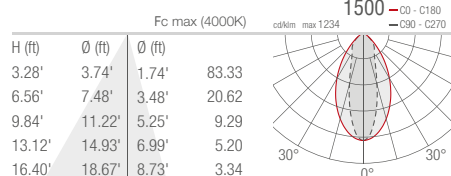

SIRI 3.0 3.1

V - 6°

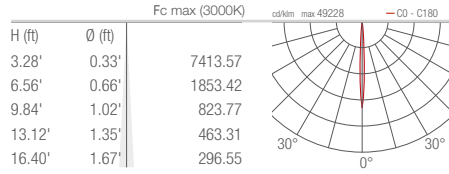

S - 12°

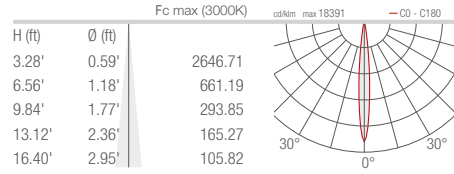

M - 30°

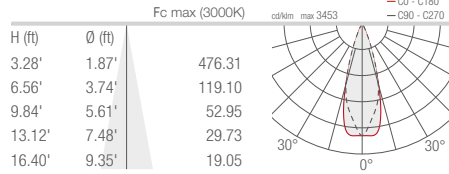

L - 40°

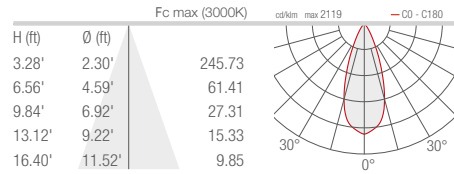

W - 10°x45°

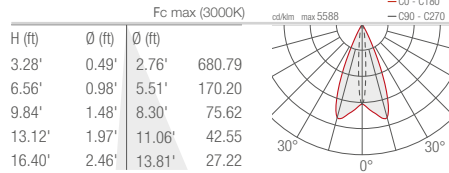

SIRI 3.2 3.3

S - 21°

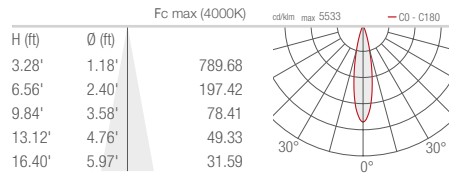

M - 32°

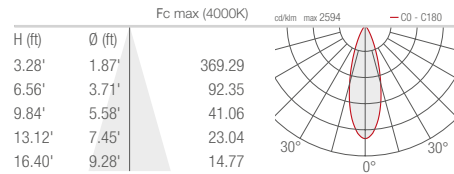

L - 58°

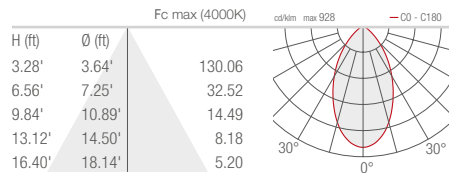

W - 30°x60°

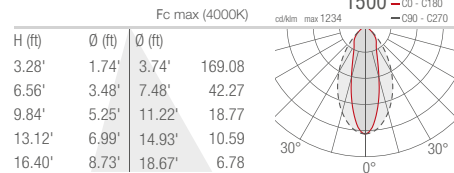

X - 60°x30°

