

Siri is a line of spotlights for indoor and outdoor applications with outstanding design featuring rounded angles. The scaled and adjustable bracket allows multiple installations on ceiling, wall, and floor.

TECHNICAL DATA

Wattage / Input	23W (24VDC)
Power Supply	Remote, not included. See page 2.
Construction	Body: Die-Cast Aluminum Lens: Tempered, Serigraphed Extra-Clear Glass Cable Length: 4.92'
CCT	2700K, 3000K, 4000K, 5000K
CRI	>80
Delivered Lumens	1491 lm (3000K, 30°)
Efficacy	64.8 lm/W (3000K, 30°)
Optics	5 Standard (see below)
Finishes	4 Standard, Custom RAL (see below)
Fixture Dimensions	1.89" l x 7.44" w x 11.14" h
Fixture Weight	4.63 lbs
LED Source	9 Power LEDs
Lumen Maintenance	L95, B10 >50,000hrs (Ta 25°C)
Color Consistency	1/4 ANSI BIN
Operating Temp.	-4°F to +113°F
IP Rating	IP66
Impact Rating	IK06



Fixture Dimensions

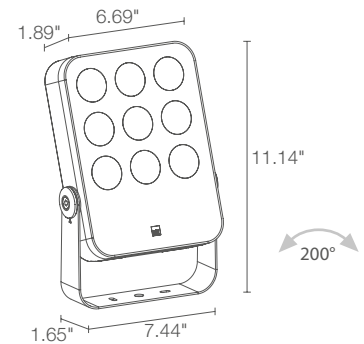

ORDERING INFORMATION

Example: SR30105ME or SR30105ME-1 Accessories / Power Supplies ordered separately.

SR3010				
Model No.	CCT	Optics	Finish	Cable Length
SR3010	F - 2700K 5 - 3000K 9 - 4000K 0 - 5000K	V - 6° S - 12° M - 30° L - 40° W - 10° x 45°	E - White F - Gray H - Anthracite T - Cor-ten C - Custom RAL (Consult factory for "C")	4.92' standard 1 - 16.40' 2 - 32.81' 3 - 49.21' 4 - 65.62'

Job Name/Date:

Fixture Type Designation:

SUGGESTED POWER SUPPLIES

24VDC

Part Number	Description	Input/Output	# of Fixtures
PPLT00155	Non-Dim	120VAC to 24VDC, 30W, Class 2	1-1
PPLT00157	Non-Dim	120VAC to 24VDC, 60W, Class 2	1-2
PPLT00543	0-10V Dimming to 15% (-40°C / -40°F cold weather start)	120-277VAC to 24VDC, 100W, Class 2	1-3

For other power supply options consult factory.

ACCESSORIES

Installation



WP0300

Ground Spike

ACCESSORIES

Anti-Glare

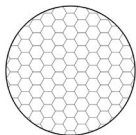

WH5030

Honeycomb Louvre
Not available for 6° optic



WB5030H

Anti-glare hood - Anthracite finish
On request the finish can match the fixture

Job Name/Date:

Fixture Type Designation:

PHOTOMETRIC DATA

Note all Photometry is 3000K

V - 6°

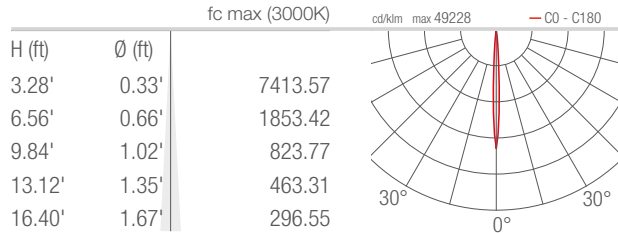

S - 12°

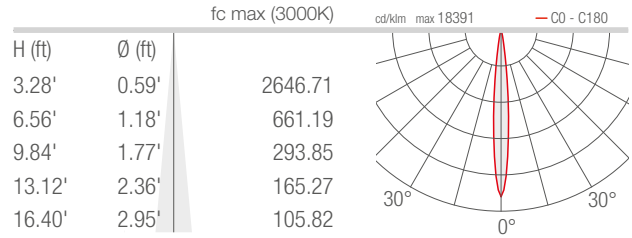

M - 30°

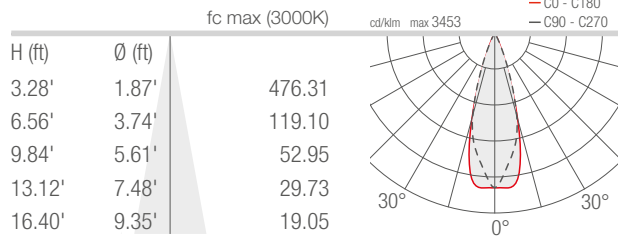

L - 40°

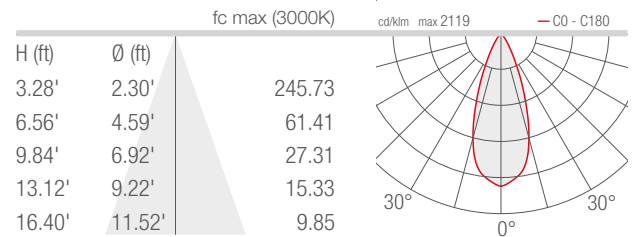

W - 10°x45°

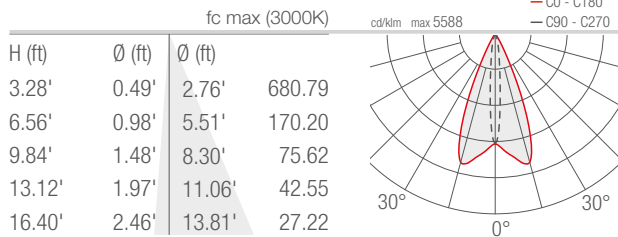

Job Name/Date:

Fixture Type Designation: