

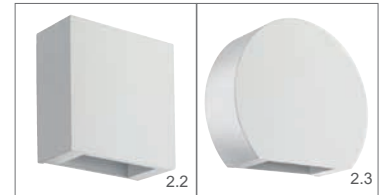

**INSTRUCTIONS PERTAINING TO RISK OF FIRE OR INJURY TO PERSONS. READ ALL INSTRUCTIONS. IMPORTANT SAFETY INSTRUCTIONS. SAVE THESE INSTRUCTIONS.**

**DANGER - RISK OF SHOCK - DISCONNECT POWER BEFORE INSTALLATION! Please read all instructions before installation.**

- Keep these instructions for future reference.
- Must be installed by a qualified electrician in accordance with national and local standards. Designplan is not responsible for fixtures installed without regard to these standards.
- Unauthorized alterations or tampering of product voids warranty.
- The main power connection must be in accordance with local electrical codes.
- Suitable for INDOOR applications.
- **DO NOT INSTALL INSULATION WITHIN 3.0" (76 mm) OF ANY PART OF THE LUMINAIRE.**



**IP40**

## Electrical Connections:

- LED lights must be **connected in series** respecting polarities.
- **CHOOSE POWER SUPPLY ACCORDINGLY.** Please consider the voltage through which fixtures are fed as well as the max power consumption.
- **Connect power only if all fixtures are connected.**
- The power supplies **MUST** be installed in aerated rooms, far from heat sources. Overworking or lack of air circulation will not permit natural dissipation.
- The electronic power supply is current-stable, therefore it partially compensates the voltage-drop problems related to the cable length; we suggest not to exceed 100 ft.
- Use only Class 2 type electronic power supply.
- Never use switches on secondary circuit.

## Maintenance

Scheduled maintenance must be carried out once a year on all lighting devices, regardless of appliance class and type of use. It must include the following operations:

- Periodically clean fixtures to remove dirt from gratings and screw heads.
- Check tightness of screws on various parts of the device.
- Check that all cable glands and cables are intact and tight. Check that the glass or plastic lens is intact, and replace it if broken or damaged.
- The internal components such as the ballast, driver, washers and screws must not show clear signs of oxidation or rust. Clear traces of rust and oxidation will indicate the presence of water inside the device.
- In the case of damage, the components must be replaced by original components or spare parts.

# STEP INSIDE 2.2, 2.3

## Fixture Installation

- It is the contractor's responsibility to caulk around all seams of fixture to satisfy wet label requirements.
- It is the contractor's responsibility to install Remote Driver in a suitable electrical enclosure.

### RECESSED INSTALLATION

Package Contents

STEP  
INSIDE 2.2

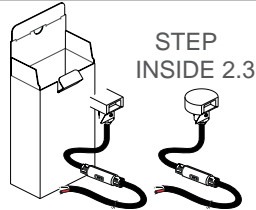

STEP  
INSIDE 2.3

1

2

Use gel-filled waterproof wire-nuts for wire connections.

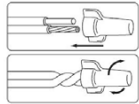

500mA

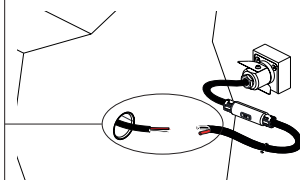

3



Clockwise rotation

4

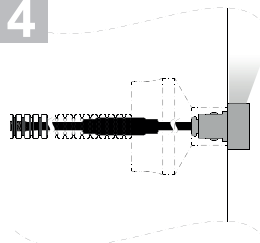

(WC0201)

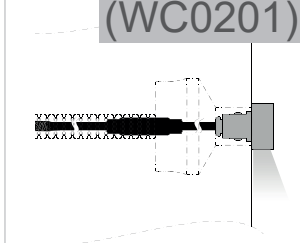

Use corrugated  $\text{\O}0.787''$  minimum  
(recommended  $\text{\O}0.984''$ )

4

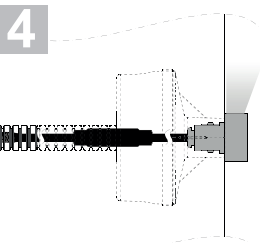

(WC0202)

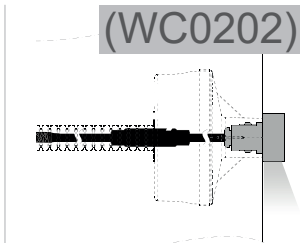

Use corrugated  $\text{\O}0.79''$  minimum  
(recommended  $\text{\O}0.98''$ )

### WALL INSTALLATION

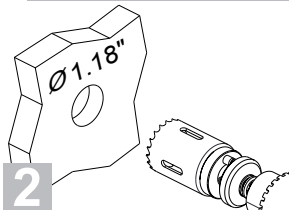

2

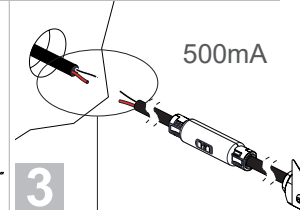

3

Use gel-filled waterproof wire-nuts for wire connections.

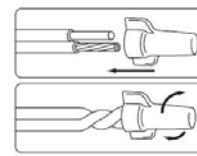

4

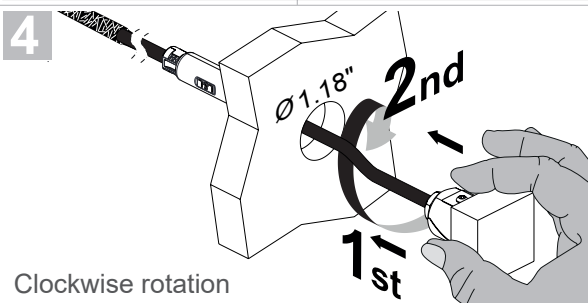

Clockwise rotation

Use corrugated  $\text{\O}0.79''$  minimum (recommended  $\text{\O}0.98''$ )

5

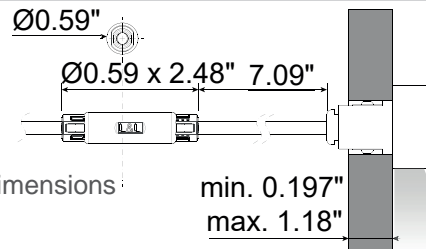

Overall dimensions:

min.  $0.197''$   
max.  $1.18''$

6

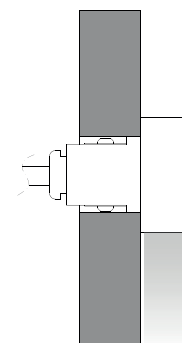
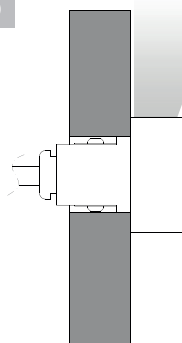

## Wiring Diagram

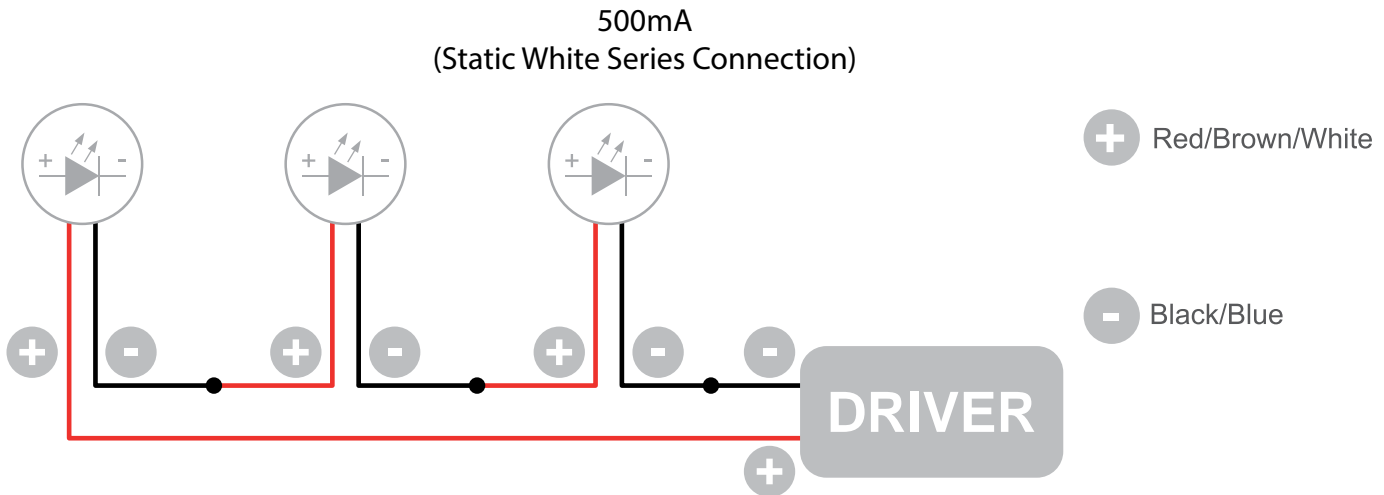

 The individual lamps must be connected in series.  
Only power up the system once all the lamps have been connected.

- LED lights work at constant current. When choosing a power supply unit, you need to consider the current by which the LEDs are driven and their maximum power consumption.
- Only power up the system once all the lamps are connected. Connecting an individual lamp to an active power supply may cause the lamp to break due to over-voltage.
- The electronic power supply is constant current, so to a certain extent it automatically compensates the voltage drop associated with cable length; however, we advise not exceeding 100 feet.
- Lamps and power supply units must be installed in well-ventilated boxes or locations to allow a natural heat diffusion and avoid the devices overheating.
- On the power system, install a surge protection device to reduce the intensity of any voltage spikes to protect the lighting fixtures from the risk of damage.
- Fixture NOT suitable for covering with thermally insulating material.