

The Stra family of in-grades uplights are robust and powerful. With an IP69K rating (making them suitable for power washing) along with an optional IP68 housing, these fixtures are durable. Various optics and static white available. RGBW available on the Stra 5.0. Dimming available on Stra 1.0.

## TECHNICAL DATA

<b>Wattage / Input</b>	37W (120VAC)
<b>Power Supply</b>	Integral (0-10V Dimming Available)
<b>Construction</b>	Body: Aluminum Alloy EN AB 47100 Trim: AISI 316L Stainless Steel Lens: Extra-clear Tempered Glass
<b>CCT</b>	2700K, 3000K, 4000K (3500K available, consult factory)
<b>CRI</b>	CRI >80, >90
<b>Delivered Lumens</b>	2024 lm (3000K, 30°, CRI 80) 2205 lm (3000K, 66°x11° tiltable, CRI 80) 1420 lm (3000K, wall washer, CRI 80) 1619 lm (3000K, 30°, CRI 90) 1764 lm (3000K, 66°x11° tiltable, CRI 90) 1136 lm (3000K, wall washer, CRI 90)
<b>Efficacy</b>	30.7-59.6 lm/W
<b>Optics</b>	7 Standard (see below)
<b>Finishes</b>	Micro-Blasted Stainless Steel
<b>Fixture Dimensions</b>	Ø11.42" x 5.43"
<b>Aperture</b>	Ø7.13"
<b>Fixture Weight</b>	11.02 lbs
<b>LED Source</b>	4 High-Intensity Power LED
<b>Lumen Maintenance</b>	L90, B10>50,000hrs (Ta 25°C)
<b>Color Consistency</b>	3-Step MacAdam
<b>Operating Temp.</b>	-4°F to +113°F
<b>IP Rating</b>	IP69K, IP68 with purpose-built outer casing
<b>IK Rating</b>	IK10



Fixture Dimensions

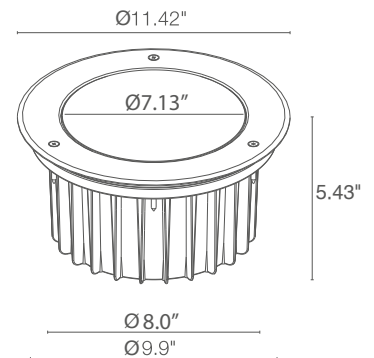

Wall Washer Optics

## ORDERING INFORMATION

Example: CS10100FMI. Accessories ordered separately.

CS1010					
Model No.	CRI	CCT	Optics		Finish / Dimming
CS1010	0 - 80 CRI 1 - 90 CRI	F - 2700K 5 - 3000K 9 - 4000K	V - 11° S - 14° M - 30° L - 37°	W - 10° x 45° X - 66°x11° tiltable H - Wall Washer	I - Stainless Steel / Non-Dim IR - Stainless Steel / 0-10V

Job Name/Date:

Fixture Type Designation:

## ACCESSORIES

### Anti-Glare

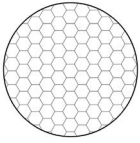

#### WH0610

Honeycomb Louvre  
*Not available for 66°x11°  
and wall washer optics*

## ACCESSORIES

### Installation

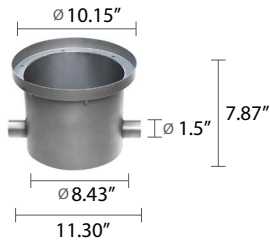

**WC5611-US**  
Outer Casing  
IP68



**WE0202**  
Tamper-resistant  
screw kit



**WE0203**  
Screwdriver for tamper  
resistant screws



**WN7001**  
Pair of extractors  
for outer casings



**WE0201**  
Magnet for 66°x11° optics

Job Name/Date:

Fixture Type Designation:

## PHOTOMETRIC DATA

Note all Photometry is CRI 80, 3000K

### V - 11° CRI 80 (Stra 1.0 - 2.0 - 3.0)

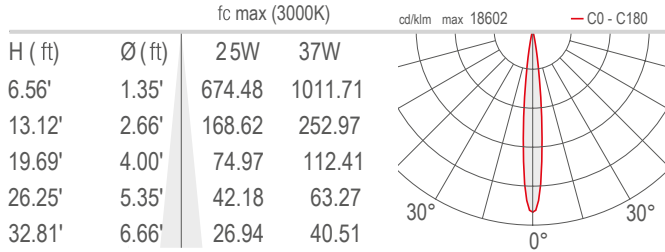

### S - 14° CRI 80

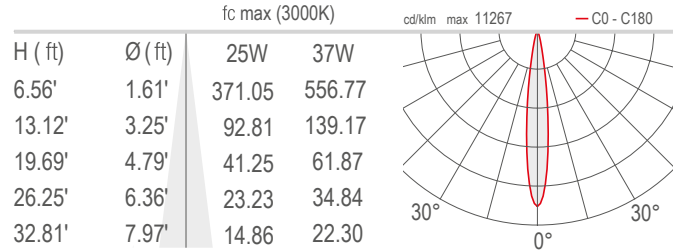

### M - 30° CRI 80

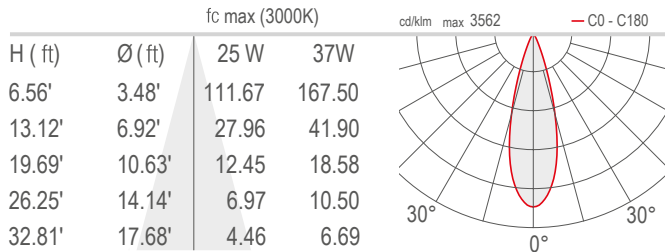

### L - 37° CRI 80

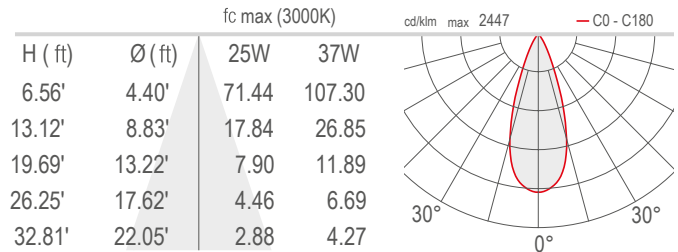

### W - 10°x45° CRI 80

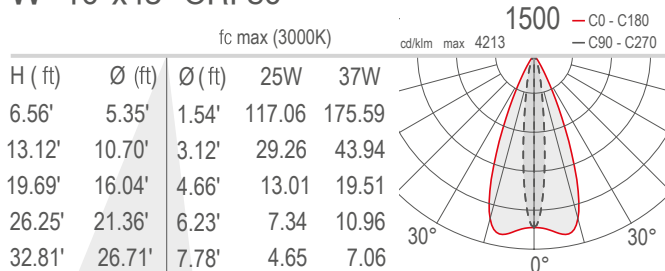

### X - 66°x11° CRI 80 (Stra 1.0)

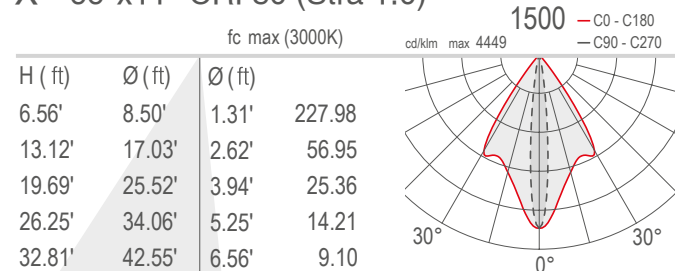

### H - Wall washer CRI 80 (Stra 1.0)

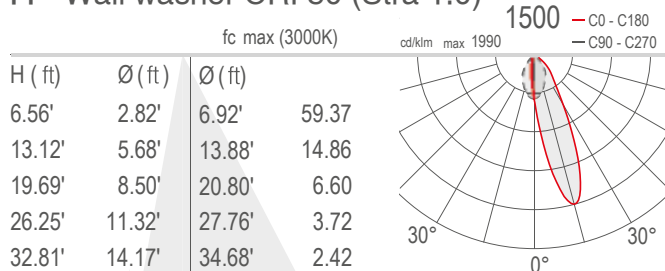

Job Name/Date:

Fixture Type Designation: