

Harmony and Functionality.

kubs

design by Landa R&D

designplan 

79 Trenton Avenue
Frenchtown, NJ 08825

www.designplan.com

Tel: (908) 996-7710
Fax: (908) 996-7042



kubs

Harmonious and compact design, a 3D bollard with variable height, perfect for enhancing and illuminating external paths and access routes. A luminaire supplied with 3W and 6W single or double emission power with asymmetrical light beam. The two available finishes, graphite and oxide, expand the aesthetic possibilities, combining function with technical quality. Precise light beams for high impact effects even in extreme outdoor conditions.

KUBS | WALL LAMP also available



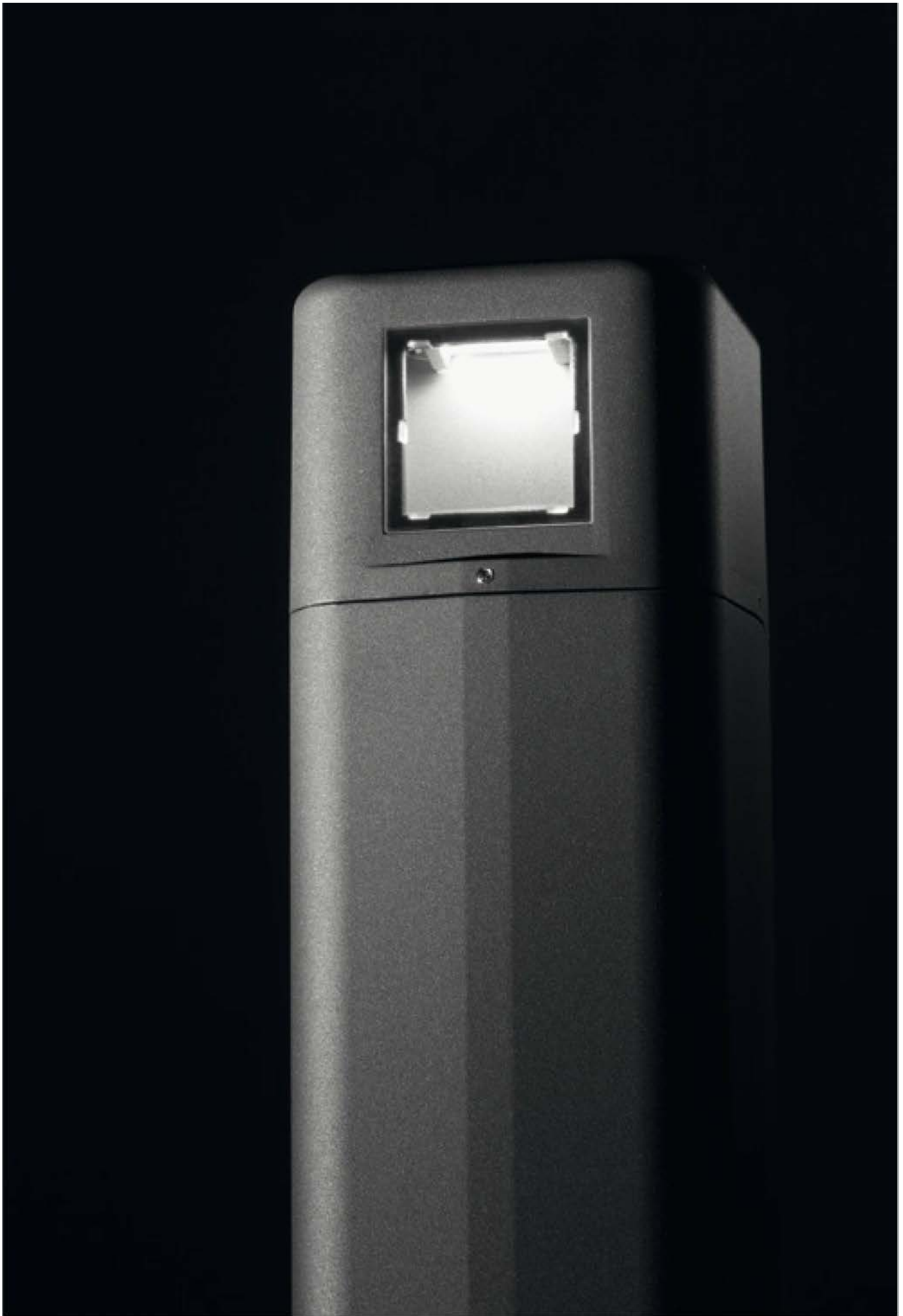

kubs

SINGLE ASYMMETRIC

3W



TECHNICAL SPECIFICATIONS

	SINGLE ASYMMETRIC
Source lamp	LED 3W
Total wattage	5.5W
Voltage	120 VAC, 50-60 Hz
Control	On/Off • Consult factory for dimmable options
Light color	3000K • other colors on request
Delivered lumens *Lumens at source	119 lm (260 lm*)
Luminous efficacy	22 lm/W
McADAM steps	3
Beam	Asymmetric
CRI	> 90
Life time	L70 > 50.000 h Ta 40°C
IP rating	IP65
IK rating	IK08

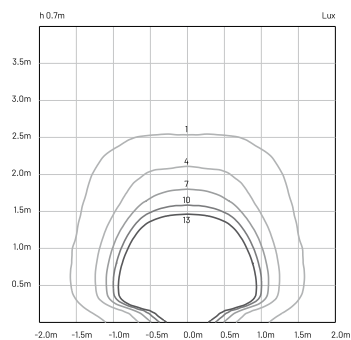
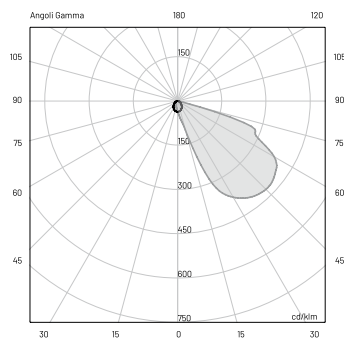



MATERIALS

Body	Die-cast aluminum EN47100 and extruded aluminum EN AW6060
Diffuser	Extra clear PMMA
Finishing	Polyester powder paint

ORDER CODE

KU 3 0 ____ A H B 1 0 _

Finishing	L Graphite	
	V Oxide	
Height	012 4.72"	
	035 13.78"	
	070 27.56"	

Example KU 3 0 012 A H B 1 0 L

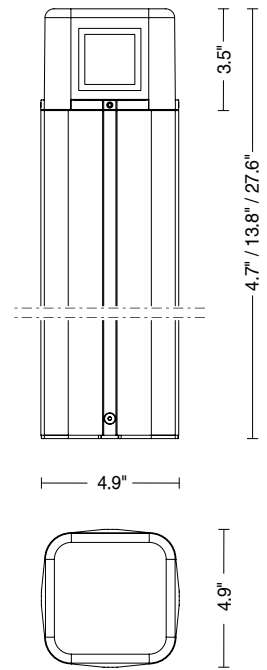

AVAILABLE ACCESSORIES

Code	Description
<u>00A404.01P</u>	Anchor bolt
<u>0404M003</u>	Loop-in loop-out IP68



kubs

SINGLE ASYMMETRIC

6W



TECHNICAL SPECIFICATIONS

	SINGLE ASYMMETRIC
Source lamp	LED 6W
Total wattage	9W
Voltage	120 VAC, 50-60 Hz
Control	On/Off • Consult factory for dimmable options
Light color	3000K • other colors on request
Delivered lumens *Lumens at source	240 lm (520 lm*)
Luminous efficacy	27 lm/W
McADAM steps	3
Beam	Asymmetric
CRI	> 90
Lifetime	L70 > 50.000 h Ta 40°C
IP rating	IP65
IK rating	IK08

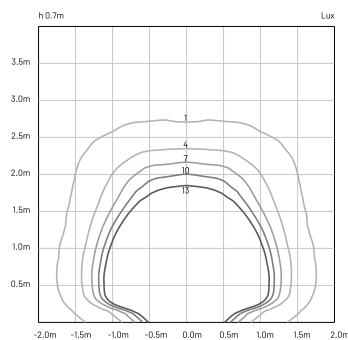
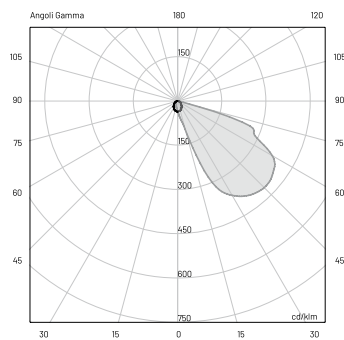



MATERIALS

Body	Die-cast aluminum EN47100 and extruded aluminum EN AW6060
Diffuser	Extra clear PMMA
Finishing	Polyester powder paint

ORDER CODE

KU 31 ___ AHB10 _

Finishing	L	Graphite	
	V	Oxide	
Height	012	4.72"	
	035	13.78"	
	070	27.56"	

Example: KU 31 012 AHB10 L

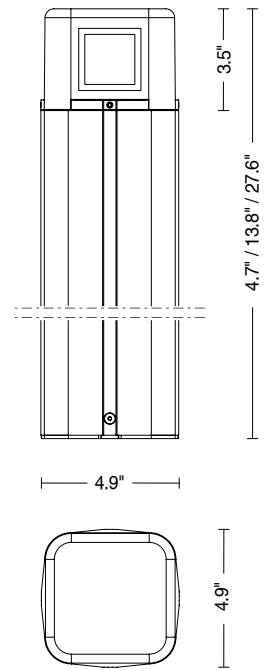

AVAILABLE ACCESSORIES

Code	Description
00A404.01P	Anchor bolt
0404M003	Loop-in loop-out IP68



kubs

DOUBLE ASYMMETRIC

6W



TECHNICAL SPECIFICATIONS

	DOUBLE ASYMMETRIC
Source lamp	LED 6W
Total wattage	9W
Voltage	120 VAC, 50-60 Hz
Control	On/Off • Consult factory for dimmable options
Light color	3000K • other colors on request
Delivered lumens *Lumens at source	240 lm (520 lm*)
Luminous efficacy	27 lm/W
McADAM steps	3
Beam	Asymmetric
CRI	> 90
Life time	L70 > 50.000 h Ta 40°C
IP rating	IP65
IK rating	IK08

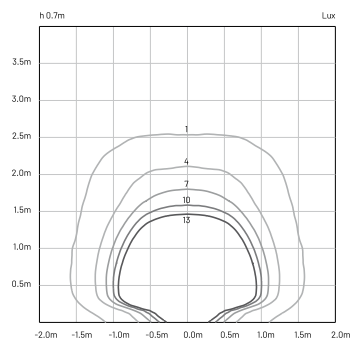
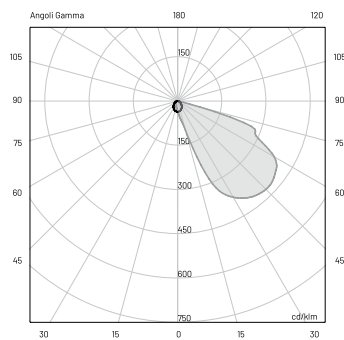

MATERIALS

Body	Die-cast aluminum EN47100 and extruded aluminum EN AW6060
Diffuser	Extra clear PMMA
Finishing	Polyester powder paint

ORDER CODE

KU 3 0	4	H B 1 0	_	Finishing	L	Graphite	●
					V	Oxide	●
				Height	012	4.72"	
					035	13.78"	
					070	27.56"	
Example					KU 3 0 012 4 H B 1 0 L		

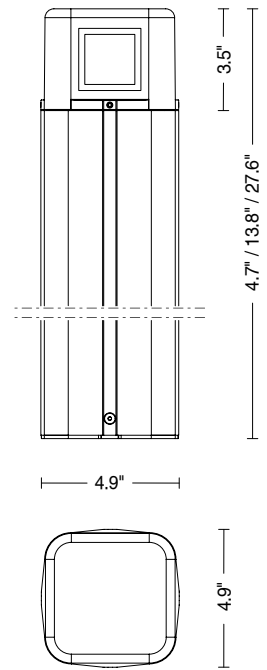

AVAILABLE ACCESSORIES

Code	Description
00A404.01P	Anchor bolt
0404M003	Loop-in loop-out IP68





