

CENTAUR C1.0 - C1.S

The Centaur C1.0 is a 1.5" diameter round in-grade uplight made of stainless steel that is suitable for power washing and is driveover rated up to 11,000 lbs. It is available in RGBW or RGBA (A for Amber). Field addressable. Also available in a square version (C1.S).



TECHNICAL DATA

| | |
|---------------------------|---|
| Wattage / Input | 4W (24VDC) |
| Power Supply | Remote, not included. See page 2. |
| Construction | Body and Trim: Stainless Steel 316 Alloy Lens: 0.4" Clear Tempered Glass Lens Frame: Threaded Bottlecap |
| CCT | RGBW or RGBA (Amber in 2000K) |
| CRI | >80 |
| BUG Rating | B0-U3-G0 - All Channels B0-U2-G0 - Red B0-U2-G0 - Green B0-U1-G0 - Blue B0-U2-G0 - White |
| Delivered Lumens | RGBW: 62 lm R: 12 lm, G: 30 lm, B: 9 lm, W: 22 lm |
| Efficacy | 31 lm/W |
| Optics | 30° standard |
| Finishes | Stainless Steel 316 Alloy |
| Fixture Dimensions | Ø1.5" x 4.3" h |
| LED Source | RGBW or RGBA LED |
| IP Rating | IP68, IP69K |
| Driveover Rated | 11,000 lbs |

Fixture Dimensions

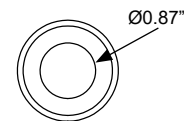
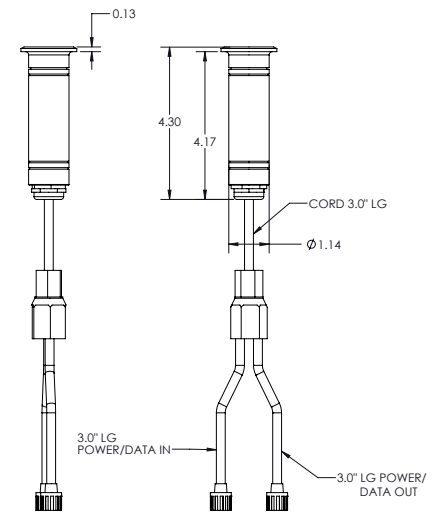

C1.0
Round Version

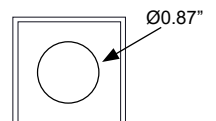

C1.S
Square Version
1.5" x 1.5"

ORDERING INFORMATION

Example: C1.0-L-1-4-SS-1-X-T-00. Power Supplies / Accessories ordered separately.

| | - | | - | 4 | - | SS | - | | - | X | - | T | - | 00 |
|-----------------|---------------|---------------------------------------|----------------------|----------|--------------------|--|-----------|--|---|---|---|---|---|----|
| Model # | CCT / Wattage | Body | Finish | Optics | Driver | Lens | Options | | | | | | | |
| C1.0-L (Round) | 1 - 4W, RGBW | 4 - Recessed box with conduit entries | SS - Stainless Steel | 0 - None | X - Remote | T - Clear Tempered | 00 - None | | | | | | | |
| C1.S-L (Square) | 2 - 4W, RGBA | | | 1 - 30° | See p.2 to specify | RDM DMX Decoder integrate into fixture housing. Fixture required an RDM controller to address and control RGBW colors (provided by others) | | | | | | | | |

Job Name/Date:

Fixture Type Designation:

SUGGESTED POWER SUPPLIES

24VDC

| Part Number | Description | Input/Output | # of Fixtures |
|---------------------------|-------------|---|---------------|
| PPLT00284 | Non-Dim | 120277VAC to 24VDC, 100W, Class 2, DAMP | 1-20 |

For other power supply options consult factory.

ACCESSORIES

Installation

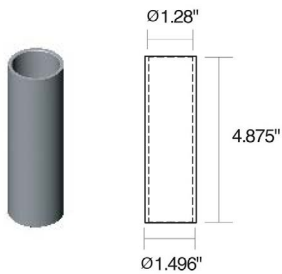

PPMP03318

Core Drilled Application Sleeve

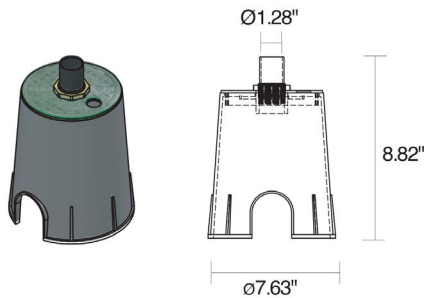

C1.0, C1.S - OH

Poured Concrete Housing

ACCESSORIES

Controllers (RGBW)

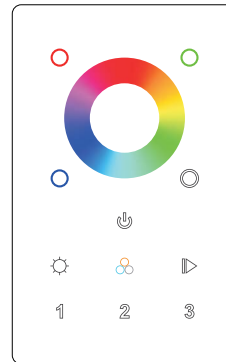

[PPWD00570](#) - RGBW DMX512+Wifi Controller

Touch Sensitive

Can be controlled by WiFi

Controls 3 zones synchronously and separately

Job Name/Date:

Fixture Type Designation:

PHOTOMETRIC DATA

Maximum Candela = 113

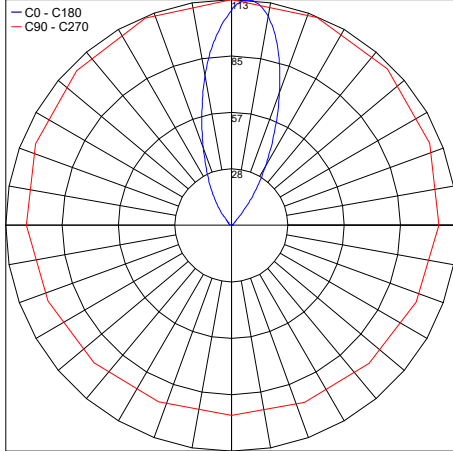

PHOTOMETRIC FILENAME : C1.0-L-2 - ALL CHANNELS (LLIA001934-005A).IES

Maximum Candela = 24

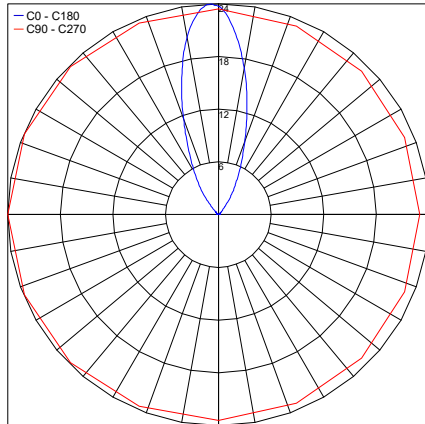

PHOTOMETRIC FILENAME : C1.0-L-2 - RED (LLIA001934-001A).IES

Maximum Candela = 57.7

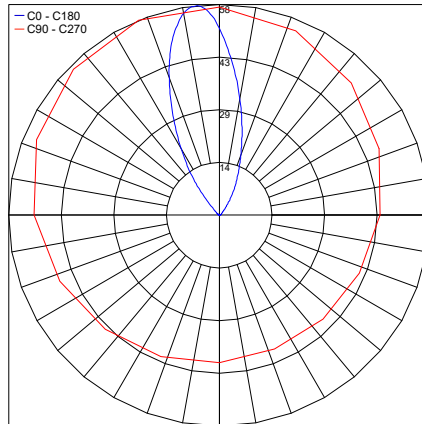

PHOTOMETRIC FILENAME : C1.0-L-2 - GREEN (LLIA001934-002A).IES

Maximum Candela = 16.3

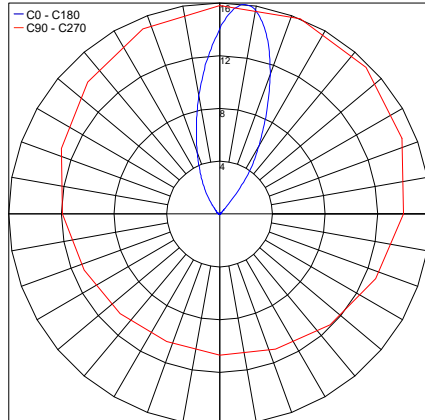

PHOTOMETRIC FILENAME : C1.0-L-2 - BLUE (LLIA001934-003A).IES

Maximum Candela = 40.1

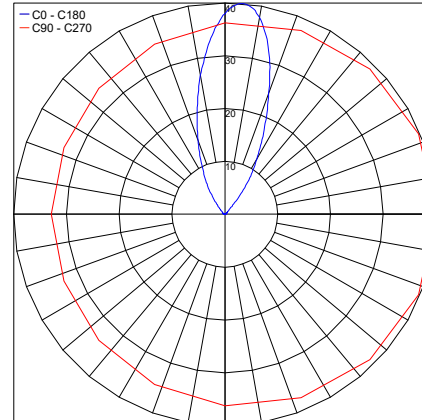

PHOTOMETRIC FILENAME : C1.0-L-2 - 3000K WHITE (LLIA001934-004A).IES

Job Name/Date:

Fixture Type Designation: