



INSTRUCTIONS PERTAINING TO RISK OF FIRE OR INJURY TO PERSONS. READ ALL INSTRUCTIONS. IMPORTANT SAFETY INSTRUCTIONS. SAVE THESE INSTRUCTIONS.

DANGER - RISK OF SHOCK - DISCONNECT POWER BEFORE INSTALLATION! Please read all instructions before installation.

- Keep these instructions for future reference.
- Must be installed by a qualified electrician in accordance with national and local standards. Designplan is not responsible for fixtures installed without regard to these standards.
- The main power connection must be in accordance with local electrical codes.
- Unauthorized alterations or tampering of product voids warranty.
- Suitable for OUTDOOR applications.



IP68 IP69K

Electrical Connections:

- LED lights must be **connected in series** respecting polarities.
- **CHOOSE POWER SUPPLY ACCORDINGLY.** Please consider the voltage through which fixtures are fed as well as the max power consumption.
- **Connect power only if all fixtures are connected.**
- This unit must be used in conjunction with a suitable fountain rated power supply.
- The electronic power supply is current-stable, therefore it partially compensates the voltage-drop problems related to the cable length; we suggest not to exceed 100 ft.
- Use only Class 2 type electronic power supply.
- Never use switches on secondary circuit.

ATTENTION: **For In-Grade** - It is the contractor's responsibility to seal the conduit with "Great Stuff" aerosol seal that prevents water and moisture penetration for ultimate protection. Contractor **MUST** use gel-filled wire nuts.

Maintenance

Scheduled maintenance must be carried out once a year on all lighting devices, regardless of appliance class and type of use. It must include the following operations:

- Periodically clean fixtures to remove dirt from gratings and screw heads.
- Check tightness of screws on various parts of the device.
- Check that all cable glands and cables are intact and tight. Check that the glass or plastic lens is intact, and replace it if broken or damaged.
- The internal components such as the ballast, driver, washers and screws must not show clear signs of oxidation or rust. Clear traces of rust and oxidation will indicate the presence of water inside the device.
- In the case of damage, the components must be replaced by original components or spare parts.

PPMP03329 CORE DRILL HOUSING

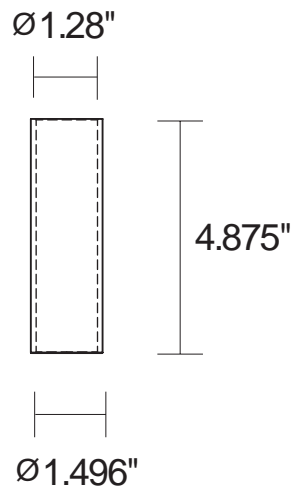

C1.0 - OH POURED CONCRETE HOUSING

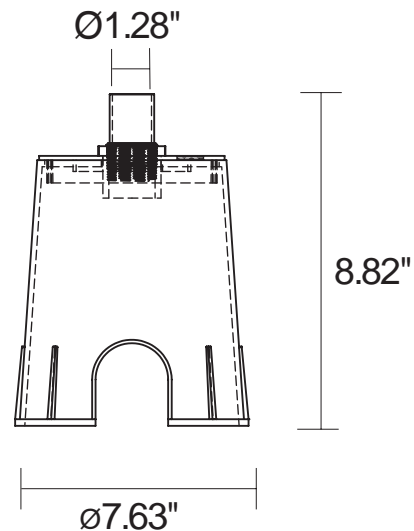
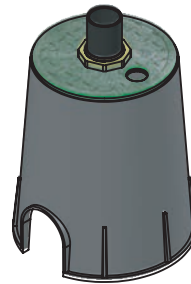

1. Place the outer casing with its upper part at the ground level, bearing in mind to foresee a suitable draining in the lower part.
2. Block the outer casing and lay the cement bed, trying to avoid air bubbles which would compromise the mechanical resistance.
3. Apply the tape in order to prevent any foreign bodies from entering the outer casing.
4. Housing can be trimmed to size if necessary.

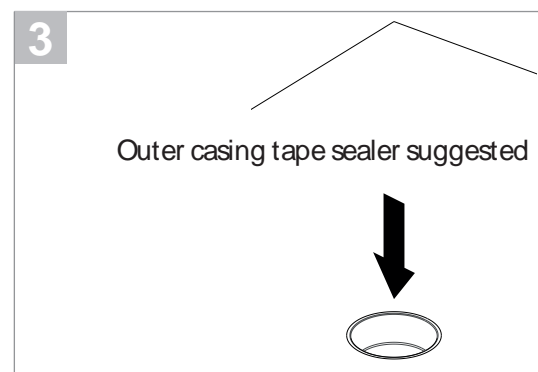
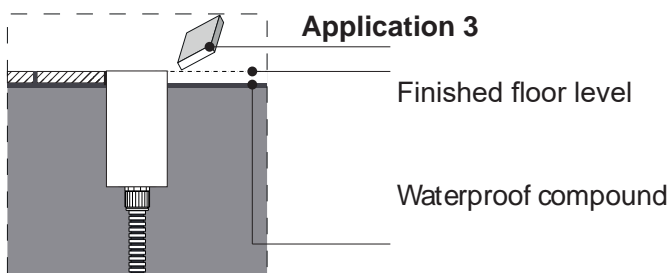
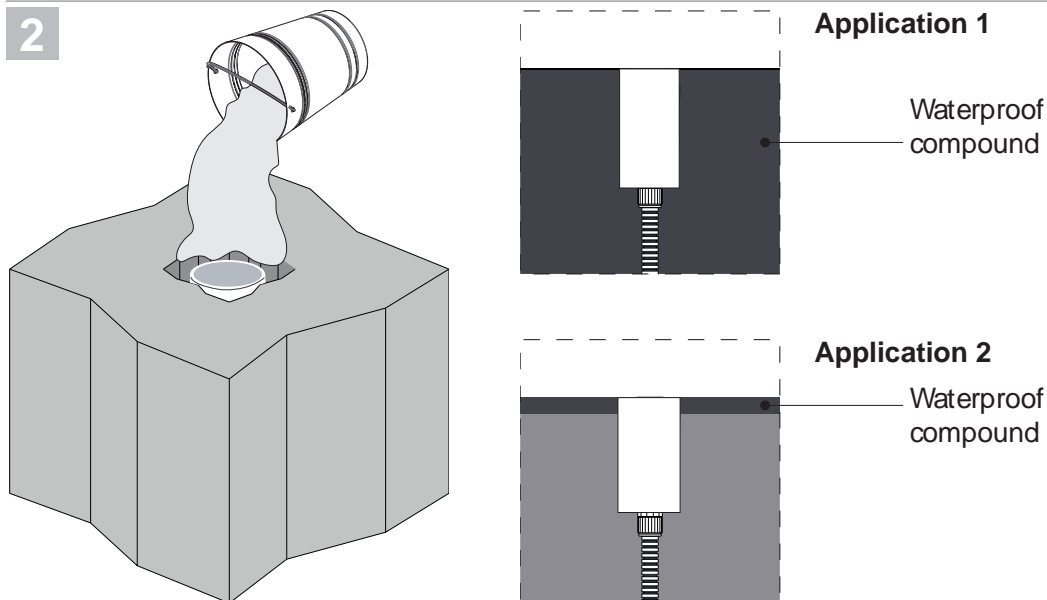
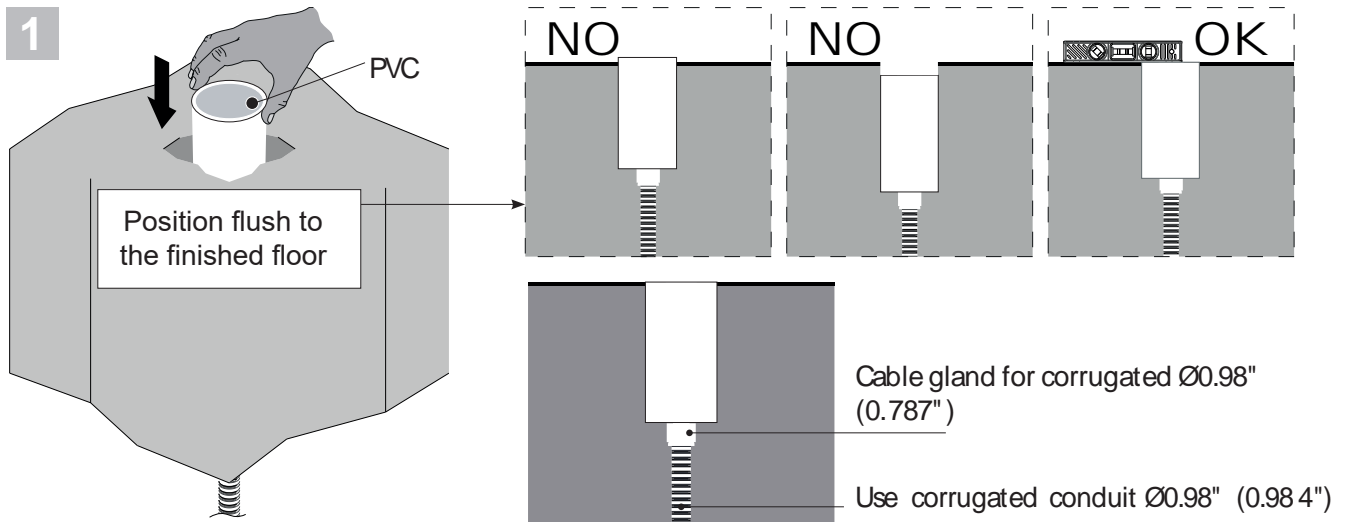

1

C1.0(Round)
CS.0(Square)

C1.H

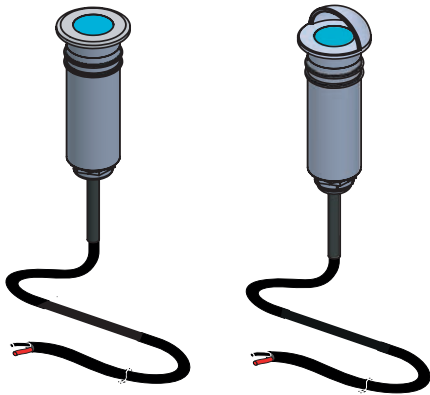

2

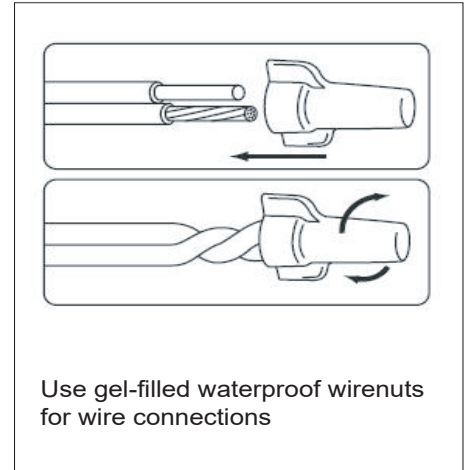
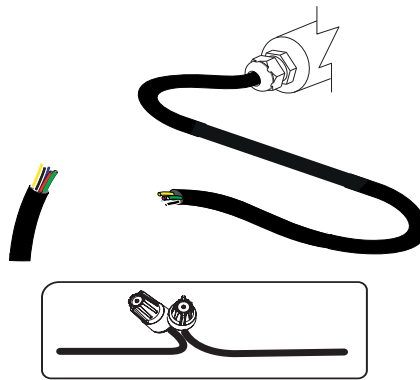

3

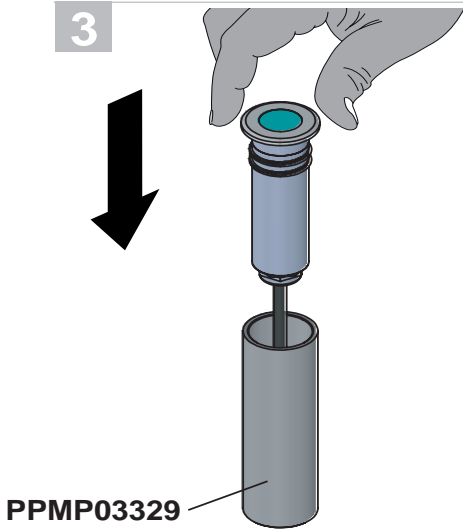

4 (PPMP03329 / C1.0- OH)

24 VDC RGBW

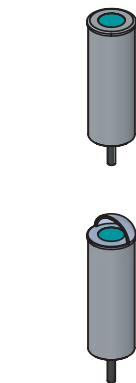

with PPMP03329

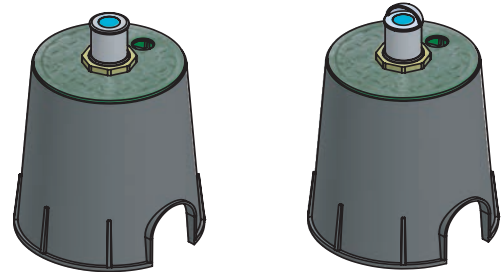

with C1.0-OH

- It is the contractor's responsibility to install Remote Driver in a suitable electrical enclosure.
- It is the contractor's responsibility to caulk around the edges between the fixture and the mounting surface, to satisfy wet label requirements.

WIRE DIAGRAM

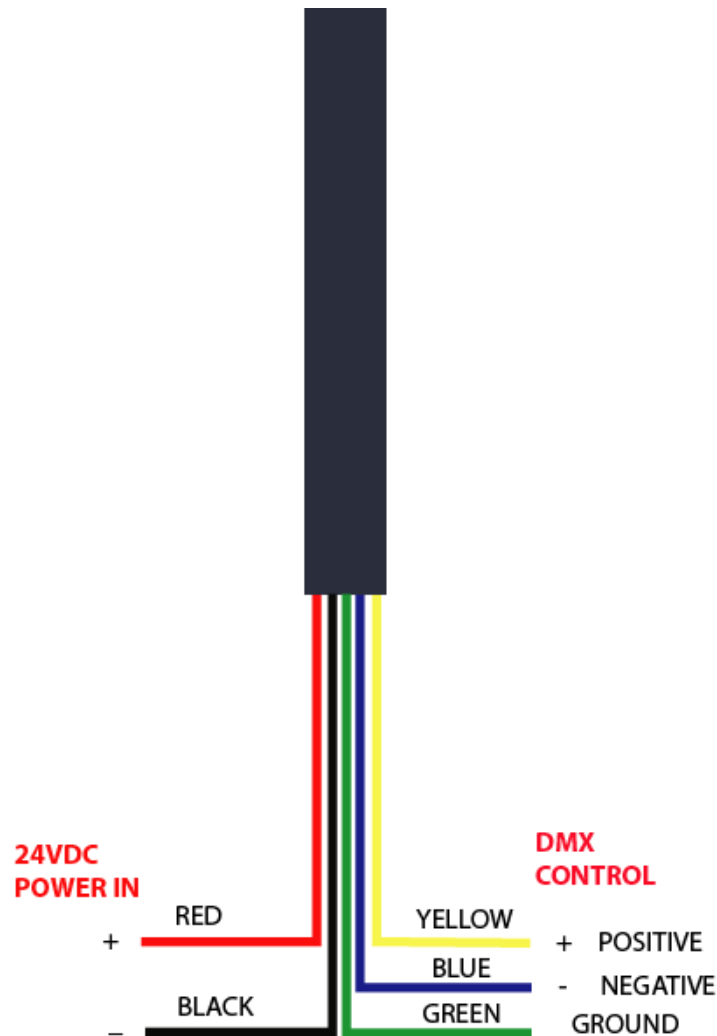

- Only power up the system once all the lamps are connected. Connecting an individual lamp to an active power supply may cause the lamp to break due to over-voltage.
- Power supply units must be installed in well-ventilated boxes or locations to allow a natural heat diffusion and avoid the devices overheating.
- On the power system, install a surge protection device to reduce the intensity of any voltage spikes to protect the lighting fixtures from the risk of damage.