

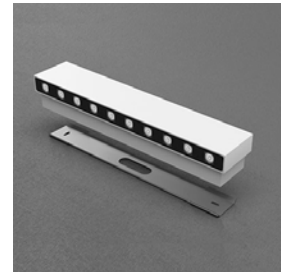

INSTRUCTIONS PERTAINING TO RISK OF FIRE OR INJURY TO PERSONS. READ ALL INSTRUCTIONS. IMPORTANT SAFETY INSTRUCTIONS. SAVE THESE INSTRUCTIONS.

DANGER - RISK OF SHOCK - DISCONNECT POWER BEFORE INSTALLATION! Please read all instructions before installation.

- Keep these instructions for future reference.
- Must be installed by a qualified electrician in accordance with national and local standards. Designplan is not responsible for fixtures installed without regard to these standards.
- The main power connection must be in accordance with local electrical codes.
- Unauthorized alterations or tampering of product voids warranty.
- Suitable for OUTDOOR applications.



ATTENTION: For Wall - It is the contractor's responsibility to caulk around all the edges between the fixture and the mounting surface to satisfy wet label requirements.

Maintenance

Scheduled maintenance must be carried out once a year on all lighting devices, regardless of appliance class and type of use. It must include the following operations:

- Periodically clean fixtures to remove dirt from gratings and screw heads.
- Check tightness of screws on various parts of the device.
- Check that all cable glands and cables are intact and tight. Check that the glass or plastic lens is intact, and replace it if broken or damaged.
- The internal components such as the ballast, driver, washers and screws must not show clear signs of oxidation or rust. Clear traces of rust and oxidation will indicate the presence of water inside the device.
- In the case of damage, the components must be replaced by original components or spare parts.

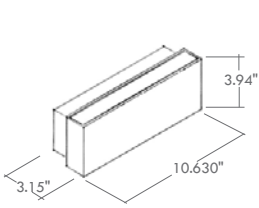

10.63" x 3.15" x H3.94"

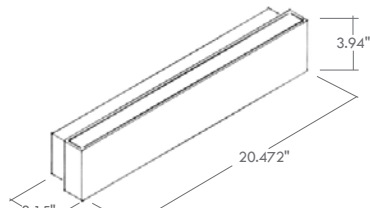

20.472" x 3.15" x H3.94"

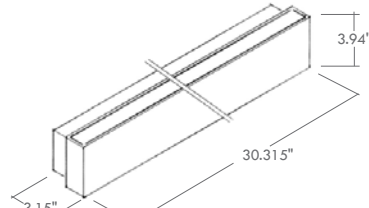

30.315" x 3.15" x H3.94"

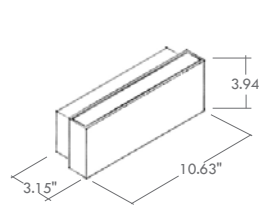

10.63" x 3.15" x H3.94"

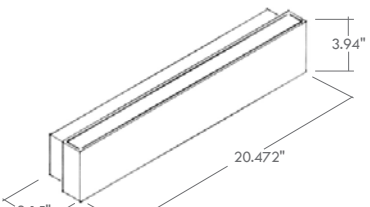

20.472" x 3.15" x H3.94"

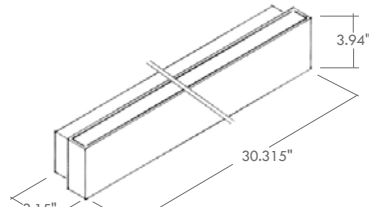

30.315" x 3.15" x H3.94"

ELEMENT PRO



Accessories

20.104652

Closing end cap

Dimensions .709" x 2" x .079"



20.104653

Pair of fixing clips

- Use wire-nuts for wire connections.

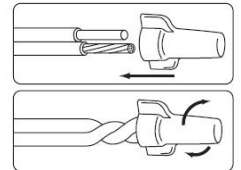

- It is the contractor's responsibility to caulk around all seams of fixture to satisfy wet label requirements.

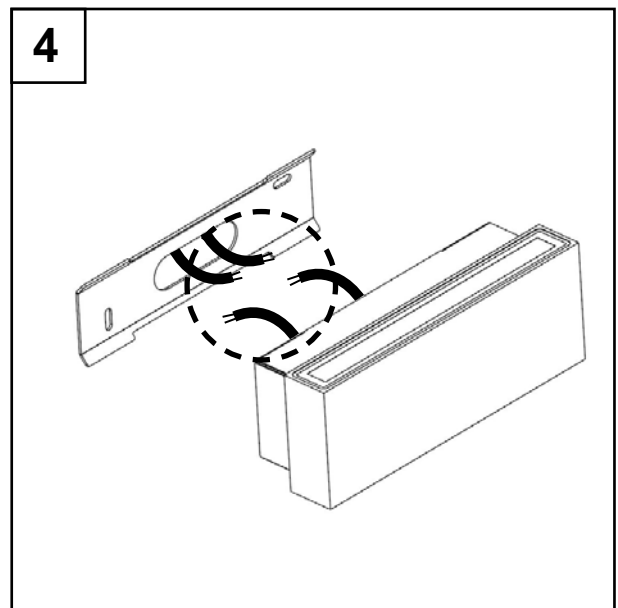
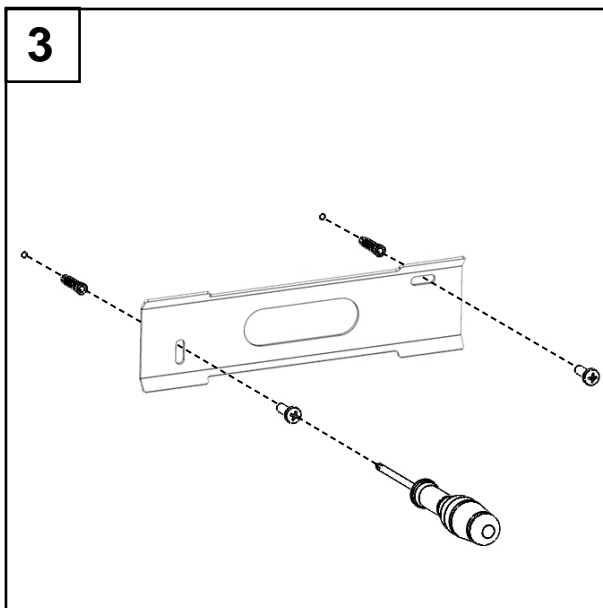
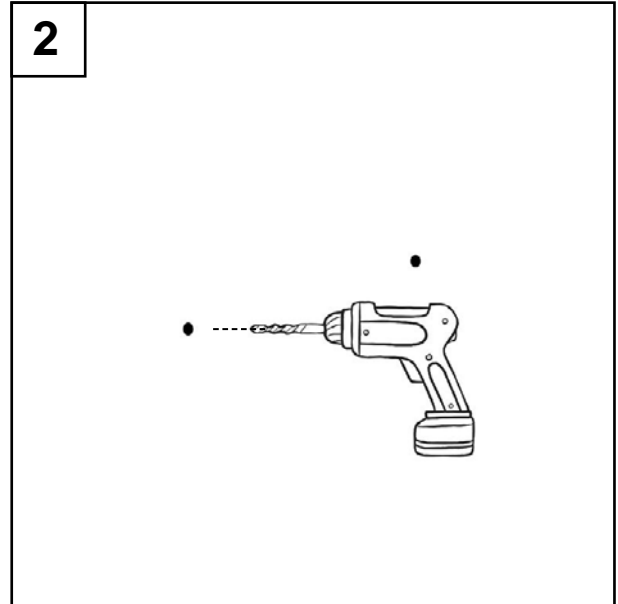
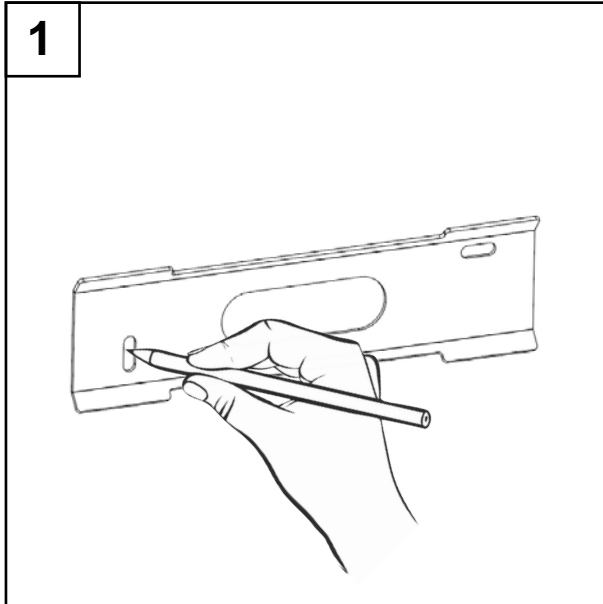

DALI VERSION

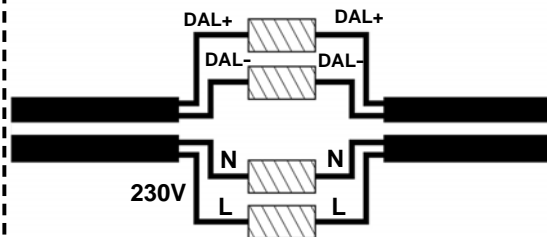

POLES JUNCTION BOX

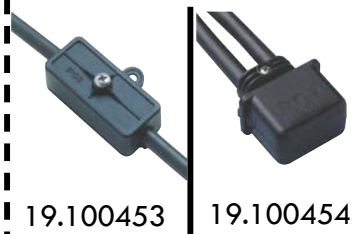

19.100453

19.100454

