

Gem Pro is a round, IP67-rated, recessed fixture with frame, suitable for installation in floors or walls, made to ensure durability and maximum resistance against atmospheric agents. Gem Pro 1 is the Ø1.6" version with 2.2W, 3 color temperatures and 5 optics options.

TECHNICAL DATA

Wattage / Input	2.2W (700mA)
Power Supply	Remote, not included. See page 2.
Construction	Body: Anticorodal Aluminum, Stainless Steel on request. Front Ring Nut: AISI 316L Stainless Steel Lens: PMMA (Acrylic) Diffuser: Extra Clear Glass Cable Length: 1.64'
CCT	2700K, 3000K, 4000K
BUG Rating	B0-U3-G0 (3000K)
Delivered Lumens	190 lm (3000K)
Efficacy	86.4 lm/W (3000K)
Optics	5 Standard, See Below
Finishes	Stainless or Bronze
Fixture Dimensions	Ø1.57" x 2.13" h
Cutout Dimensions	Ø1.26"
Color Consistency	<3-Step MacAdam
IP Rating	IP67
Driveover Capacity	Up to 6614 lbs

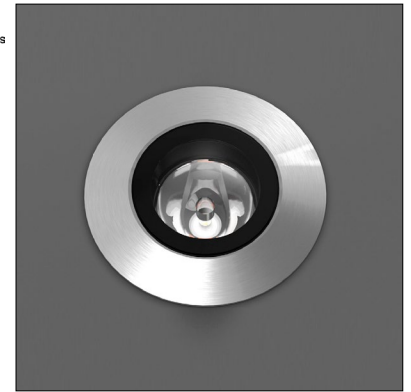

Fixture Dimensions

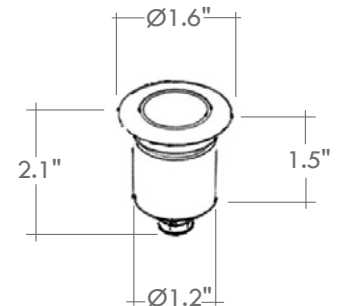

ORDERING INFORMATION

Example: LM07.104034.US.05.SS.BP. Accessories / Power Supplies ordered separately.

LM07.104034.US	.	.	.
Model No.	Finish	Optic	CCT
LM07.104034.US	05 - Stainless 59 - Bronze	SS - ≤8° SP - 10-15° MD - 20-35° FL - 40-55° HE - Horizontal Elliptical	BC - 2700K BP - 3000K BF - 4000K

Job Name/Date:

Fixture Type Designation:

SUGGESTED POWER SUPPLIES

700mA

Part Number	Description	Input/Output	# of Fixtures
PPLT00537	Non-Dim	120-277VAC to 700mA, 4W, Class 2	1-1
PPLT00470	Phase Dim (120V only)	120VAC to 700mA, 14W, Class 2	3-6
PPLT00465-P	0-10V Dimming to 1.0%	120-277VAC to 700mA, 20W, Class 2, DAMP	1-9
PPLT00261	Leading/Trailing Edge Dimming to 10% (120V only)	120VAC to 700mA, 32W, Class 2	7-14
PPLT00538-P	0-10V Dimming to 0.1% (4 Channels)	120-277VAC to 700mA, 100W, Class 2	1-44

Suggested Lutron Compatible

Part Number	Option	Lutron SKU	Dim Range	Description	Input/Output	# of Fixtures
PPLT00515	L3DAE / L3DA3W	L3DA	100%-1%	Hi-Lume™ 1% EcoSystem™ OR 1% 3-Wire LED Driver	120-277VAC to 700mA, 14W, Class 2	3-6
PPLT00579	PEQE	PEQ0	100%-0.1%	Hi-Lume™ Premier 0.1% EcoSystem™ Fade to Black	120-277VAC to 700mA, 16W, Class 2	4-7
PPLT00635	PEQE	PEQ0	100%-0.1%	Hi-Lume™ Premier 0.1% EcoSystem™ Fade to Black	120-277VAC to 700mA, 20W, Class 2	4-9
PPLT00673	PEQE	PEQ0	100%-0.1%	Hi-Lume™ Premier 0.1% EcoSystem™ Fade to Black	120-277VAC to 700mA, 20W, Class 2	4-9
PPLT00517	L3DAE / L3DA3W	L3DA	100%-1%	Hi-Lume™ 1% EcoSystem™ OR 1% 3-Wire LED Driver	120-277VAC to 700mA, 27W, Class 2	5-12
PPLT00181	L3DAE / L3DA3W	L3DA	100%-1%	Hi-Lume™ 1% EcoSystem™ OR 1% 3-Wire LED Driver	120-277VAC to 700mA, 38W, Class 2	10-17

For other power supply options consult factory.

ACCESSORIES - Installation

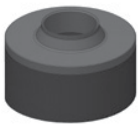

LM20.104128

Outer Casing IP20
Size $\varnothing 3.54" \times 3.35" h$
Hole $\varnothing 1.26"$



LM20.104290

Spring for installing on wall or ceiling in plasterboard.

Job Name/Date:

Fixture Type Designation:

PHOTOMETRIC DATA

Note: All photometric data is 3000K

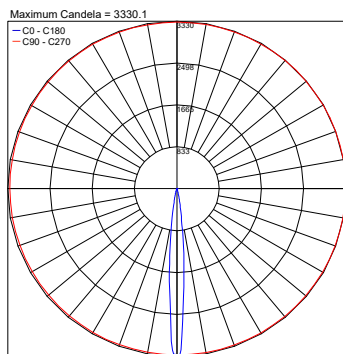

PHOTOMETRIC FILENAME : GEM PRO 1 SP 07.104034.XX.SP.BP.IES

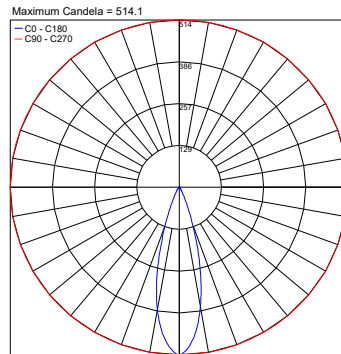

PHOTOMETRIC FILENAME : GEM PRO 1 MD 07.104034.XX.MD.BP.IES

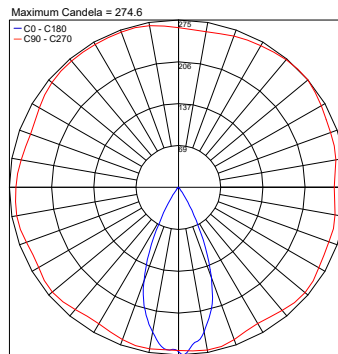

PHOTOMETRIC FILENAME : GEM PRO 1 FL 07.104034.XX.FL.BP.IES

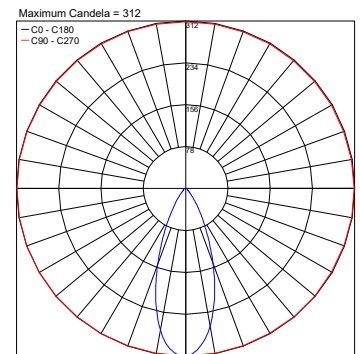

PHOTOMETRIC FILENAME : GEM PRO 1 HE 07.104034.XX.HE.BP.IES

Job Name/Date:

Fixture Type Designation: