

# Classicism and technology.

morphis

design by Innocenzo Rifino & Lorenzo Ruggieri

designplan<sup>TM</sup> 

79 Trenton Avenue  
Frenchtown, NJ 08825

[www.designplan.com](http://www.designplan.com)

Tel: (908) 996-7710  
Fax: (908) 996-7042





# morphis\_1

Morphis\_1 has the shape of the old lanterns, typical of the traditional outdoor lighting: a classical design in a contemporary key. A diffused light and an extra clear polycarbonate screen. A 29W luminaire ideal for illuminating access roads and external paths, available with extruded aluminum pole of different heights and six powder-coated finish options.

MORPHIS\_1 | WALL LAMP  
MORPHIS\_2 | WALL LAMP  
MORPHIS\_3 | WALL LAMP  
MORPHIS\_3 | PENDANT  
MORPHIS\_1 | BOLLARD





# morphis\_1

DIFFUSE

# 29W



## TECHNICAL SPECIFICATIONS

|                                    | <b>DIFFUSE (HEAD ONLY)</b>                               |
|------------------------------------|--|
| Source lamp                        | LED 29W  |
| Total wattage                      | 33W  |
| Voltage                            | xxx, 50-60 Hz  |
| Control                            | On/Off • dimmable on request                             |
| Light color                        | 3000K • 4000K • other colors on request                  |
| Delivered lumens<br>*Source lumens | 1700 lm (3400 lm*) @ 3000K<br>1800 lm (3600 lm*) @ 4000K |
| Luminous efficacy                  | 48 lm/W @ 3000K<br>52 lm/W @ 4000K                       |
| McADAM steps                       | 3  |
| Beam                               | Diffuse  |
| CRI                                | > 90   |
| Life time                          | L70 > 50.000 h Ta 40°C                                   |
| IP rating                          | IP65   |
| IK rating                          | IK08   |

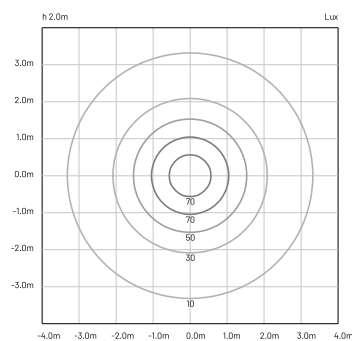
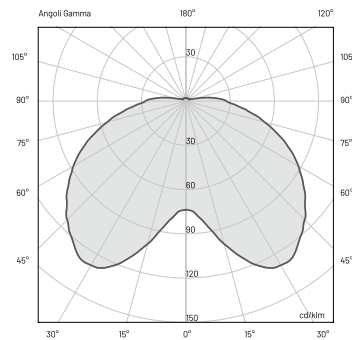

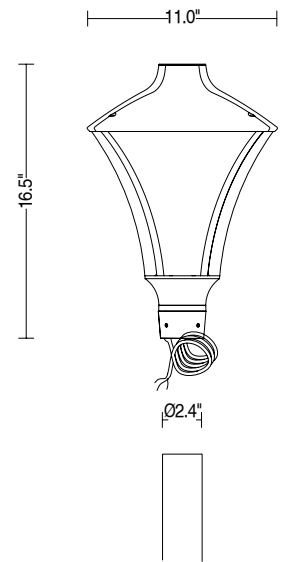







**MATERIALS**

|           |   |
|-----------|---|
| Body      | Die-cast aluminum EN47100 and extruded aluminum EN AW6060 |
| Diffuser  | Extra clear polycarbonate                                 |
| Finishing | Polyester powder paint                                    |

**ORDER CODE**

MO 4 0 PAT D \_ B 10 \_

|                    |          |              |   |
|--------------------|----------|--------------|---|
| <i>Finishing</i>   | <b>G</b> | Black        |    |
|                    | <b>S</b> | Black/copper |   |
|                    | <b>P</b> | Black/green  |  |
|                    | <b>R</b> | Black/silver |  |
|                    | <b>L</b> | Graphite     |  |
|                    | <b>V</b> | Oxide        |  |
| <i>Light color</i> | <b>N</b> | 4000K        |   |
|                    | <b>H</b> | 3000K        |   |

*Example* MO 4 0 PAT D N B 10 L

**INCLUDED ACCESSORIES**

| Code | Description                | Page |
|------|----------------------------|------|
| -    | 6.56' length cable -05RN-F | -    |



# morphis\_1

DIFFUSE

# 29W



## TECHNICAL SPECIFICATIONS

|                                    | DIFFUSE  |
|------------------------------------|--|
| Source lamp                        | LED 29W  |
| Total wattage                      | 33W  |
| Voltage                            | xxx, 50-60 Hz  |
| Control                            | On/Off • dimmable on request                             |
| Light color                        | 3000K • 4000K • other colors on request                  |
| Delivered lumens<br>*Source lumens | 1700 lm (3400 lm*) @ 3000K<br>1800 lm (3600 lm*) @ 4000K |
| Luminous efficacy                  | 48 lm/W @ 3000K<br>52 lm/W @ 4000K                       |
| McADAM steps                       | 3  |
| Beam                               | Diffuse  |
| CRI                                | > 90   |
| Life time                          | L70 > 50.000 h Ta 40°C                                   |
| IP rating                          | IP65   |
| IK rating                          | IK08   |

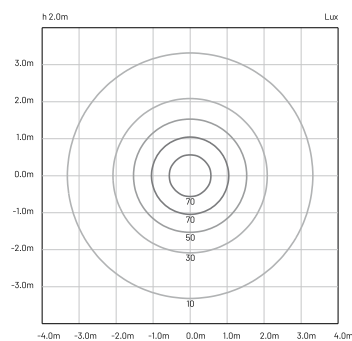
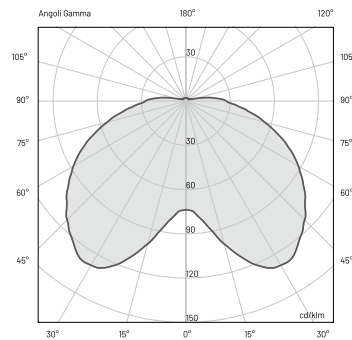

## MATERIALS

|           |  |
|-----------|--|
| Body      | Die-cast aluminum EN47100<br>and extruded aluminum EN AW6060 |
| Diffuser  | Extra clear polycarbonate                                    |
| Finishing | Polyester powder paint                                       |

## ORDER CODE

MO 4 0 \_ \_ \_ D \_ B 1 0 \_

|             |                        |              |   |
|-------------|------------------------|--------------|---|
| Finishing   | G                      | Black        | ● |
|             | S                      | Black/copper | ● |
|             | P                      | Black/green  | ● |
|             | R                      | Black/silver | ● |
|             | L                      | Graphite     | ● |
|             | V                      | Oxide        | ● |
| Light color | N                      | 4000K        |   |
|             | H                      | 3000K        |   |
| Height      | 180                    | 70.08"       |   |
|             | 200                    | 78.74"       |   |
|             | 300                    | 118.50"      |   |
| Example     | MO 4 0 180 D N B 1 0 L |              |   |

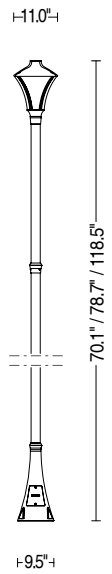

## AVAILABLE ACCESSORIES

| Code       | Description           |
|------------|-----------------------|
| 00A170.01P | Anchor bolt           |
| 0404M003   | Loop-in loop-out IP68 |







# morphis\_2

A design inspired by the classic of classics for Morphis\_2. A diffused light with extra clear transparent polycarbonate screen for a pole head that can be installed at a height of 129.92" and available in single, double or triple solution. 29W power and six finishing options, for any type of home or external public access.

MORPHIS\_1 | WALL LAMP  
MORPHIS\_2 | WALL LAMP  
MORPHIS\_3 | WALL LAMP  
MORPHIS\_3 | PENDANT  
MORPHIS\_1 | BOLLARD





# morphis\_2

1, 2, 3 LAMPS DIFFUSE

# 29W



## TECHNICAL SPECIFICATIONS <sup>1</sup>

|                   | <b>DIFFUSE</b>                          |
|-------------------|---|
| Source lamp       | LED 29W                                 |
| Total wattage     | 33W                                     |
| Voltage           | xxx, 50-60 Hz                           |
| Control           | On/Off • dimmable on request            |
| Light color       | 3000K • 4000K • other colors on request |
| Delivered lumens  | 1700 lm (3400 lm*) @ 3000K              |
| *Source lumens    | 1800 lm (3600 lm*) @ 4000K              |
| Luminous efficacy | 48 lm/W @ 3000K<br>52 lm/W @ 4000K      |
| McADAM steps      | 3                                       |
| Beam              | Diffuse                                 |
| CRI               | > 90                                    |
| Life time         | L70 > 50.000 h Ta 40°C                  |
| IP rating         | IP65                                    |
| IK rating         | IK08                                    |

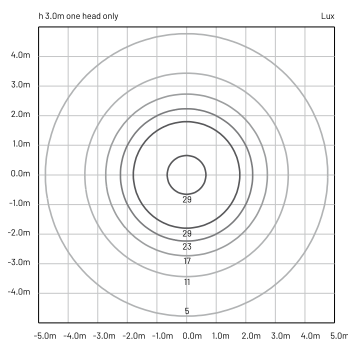
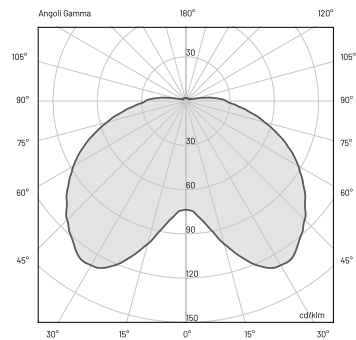

<sup>1</sup> all the technical specifications are related to one head only

## MATERIALS

|           |  |
|-----------|--|
| Body      | Die-cast aluminum EN47100<br>and extruded aluminum EN AW6060 |
| Diffuser  | Extra clear polycarbonate                                    |
| Finishing | Polyester powder paint                                       |

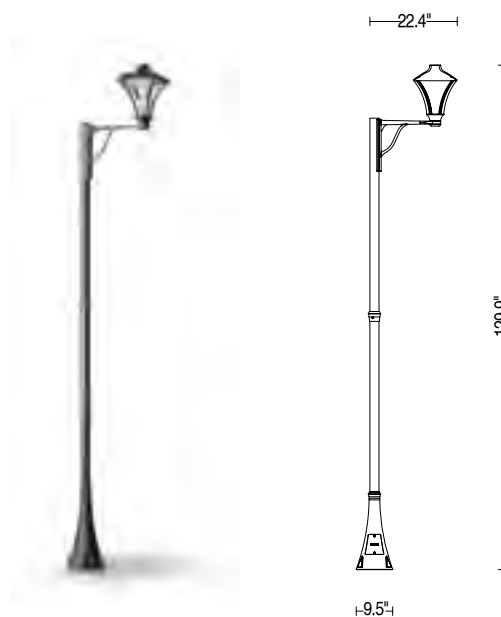

## ORDER CODE

MO 4 0 \_ \_ \_ D \_ B 1 0 \_

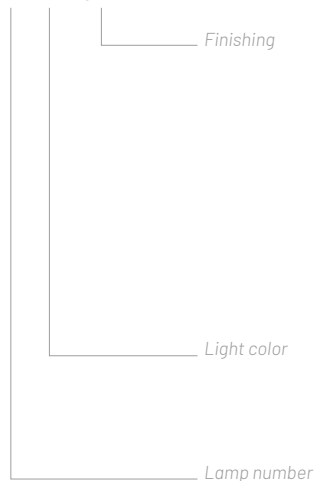

|            |              |  |
|------------|--------------|--|
| <b>G</b>   | Black        |  |
| <b>S</b>   | Black/copper |  |
| <b>P</b>   | Black/green  |  |
| <b>R</b>   | Black/silver |  |
| <b>L</b>   | Graphite     |  |
| <b>V</b>   | Oxide        |  |
| <b>N</b>   | 4000K        |  |
| <b>H</b>   | 3000K        |  |
| <b>PA1</b> | 1 lamp       |  |
| <b>PA2</b> | 2 lamps      |  |
| <b>PA3</b> | 3 lamps      |  |

Example

MO 4 0 PA1 D N B 1 0 L

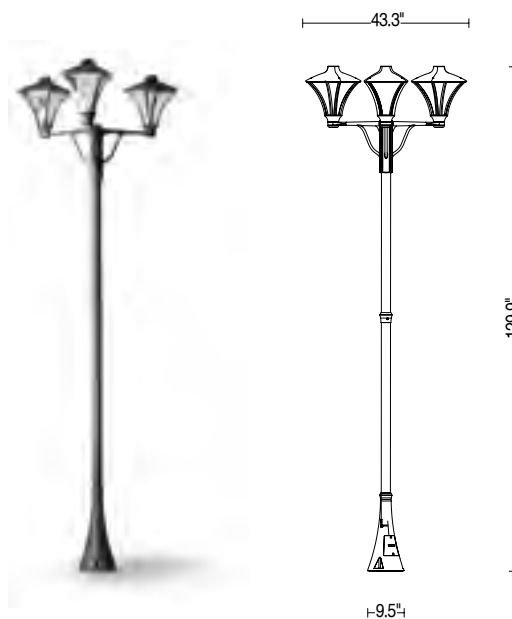

## AVAILABLE ACCESSORIES

| Code       | Description           |
|------------|-----------------------|
| 00A170.01P | Anchor bolt           |
| 0404M003   | Loop-in loop-out IP68 |

# morphis\_3

Morphis\_3 is a perfect combination of classic and contemporary.

Traditional design and innovative technology: 29W power, diffused optics and extra-clear polycarbonate. The six finishing options, the three installation solutions, single, double or triple on 118.1" pole, and the robustness of the construction components make Morphis\_3 a strong, versatile luminaire compatible with any outdoor type for the residential sector.

MORPHIS\_1 | WALL LAMP  
MORPHIS\_2 | WALL LAMP  
MORPHIS\_3 | WALL LAMP  
MORPHIS\_3 | PENDANT  
MORPHIS\_1 | BOLLARD







# morphis\_3

1, 2, 3 LAMPS DIFFUSE

# 29W



## TECHNICAL SPECIFICATIONS<sup>1</sup>

|                                    | DIFFUSE  |
|------------------------------------|--|
| Source lamp                        | LED 29W  |
| Total wattage                      | 33W  |
| Voltage                            | xxx, 50-60 Hz  |
| Control                            | On/Off • dimmable on request                             |
| Light color                        | 3000K • 4000K • other colors on request                  |
| Delivered lumens<br>*Source lumens | 1700 lm (3400 lm*) @ 3000K<br>1800 lm (3600 lm*) @ 4000K |
| Luminous efficacy                  | 48 lm/W @ 3000K<br>52 lm/W @ 4000K                       |
| McADAM steps                       | 3  |
| Beam                               | Diffuse  |
| CRI                                | > 90   |
| Life time                          | L70 > 50.000 h Ta 40°C                                   |
| IP rating                          | IP65   |
| IK rating                          | IK08   |

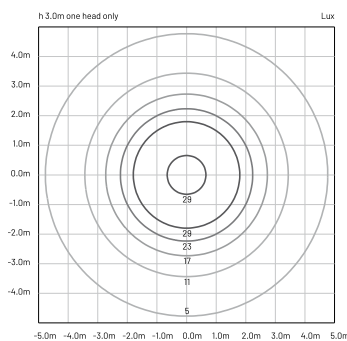
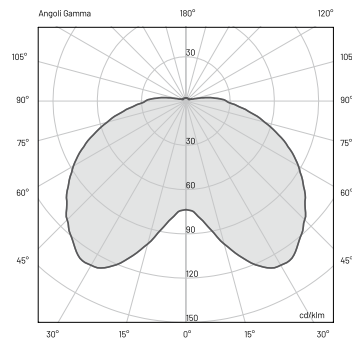

<sup>1</sup> all the technical specifications are related to one head only

## MATERIALS

|           |  |
|-----------|--|
| Body      | Die-cast aluminum EN47100<br>and extruded aluminum EN AW6060 |
| Diffuser  | Extra clear polycarbonate                                    |
| Finishing | Polyester powder paint                                       |

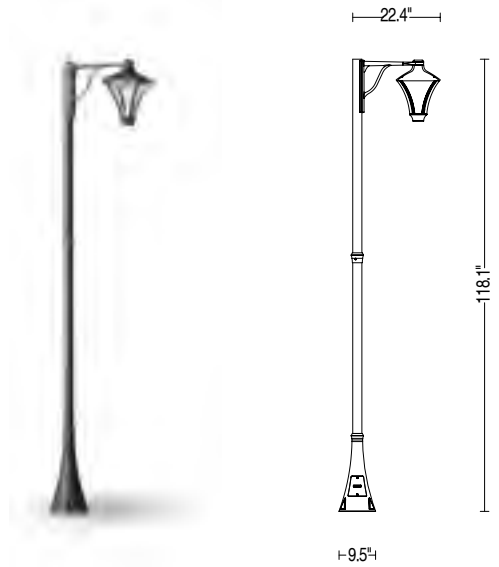

## ORDER CODE

M0 4 1 \_ \_ \_ D \_ B 1 0 \_

|             |     |              |   |
|-------------|-----|--------------|---|
| Finishing   | G   | Black        | ● |
|             | S   | Black/copper | ● |
|             | P   | Black/green  | ● |
|             | R   | Black/silver | ● |
|             | L   | Graphite     | ● |
|             | V   | Oxide        | ● |
| Light color | N   | 4000K        |   |
|             | H   | 3000K        |   |
| Lamp number | PA1 | 1 lamp       |   |
|             | PA2 | 2 lamps      |   |
|             | PA3 | 3 lamps      |   |

Example M0 4 1 PA1 D N B 1 0 L



## AVAILABLE ACCESSORIES

| Code       | Description           |
|------------|-----------------------|
| 00A170.01P | Anchor bolt           |
| 0404M003   | Loop-in loop-out IP68 |





# morphis\_4

Morphis\_4 is an exclusive and additional variant of the range where the lantern has a compact design to favor discretion. A compact pole head with diffuse optics which can be installed at a height of 118.1" in single, double or triple version. Morphis\_4 is the perfect solution for lighting gardens, access roads and outdoor paths of all types and designs. Six powder finishes are available to the designer to meet any specific need for customization.

MORPHIS\_4 | WALL LAMP  
MORPHIS\_4 | CEILING LAMP  
MORPHIS\_4 | PENDANT





# morphis\_4

1, 2, 3 LAMPS DIFFUSE

# 29W



## TECHNICAL SPECIFICATIONS <sup>1</sup>

|                   | <b>DIFFUSE</b>                          |
|-------------------|---|
| Source lamp       | LED 29W                                 |
| Total wattage     | 33W                                     |
| Voltage           | 700mA, 50-60 Hz                         |
| Control           | On/Off • dimmable on request            |
| Light color       | 3000K • 4000K • other colors on request |
| Delivered lumens  | 1550 lm (3400 lm*) @ 3000K              |
| *Source lumens    | 1650 lm (3600 lm*) @ 4000K              |
| Luminous efficacy | 44 lm/W @ 3000K<br>47 lm/W @ 4000K      |
| McADAM steps      | 3                                       |
| Beam              | Diffuse                                 |
| CRI               | > 90                                    |
| Life time         | L70 > 50.000 h Ta 40°C                  |
| IP rating         | IP65                                    |
| IK rating         | IK08                                    |

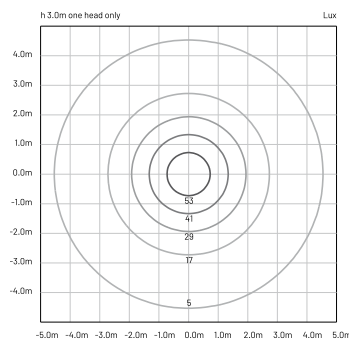
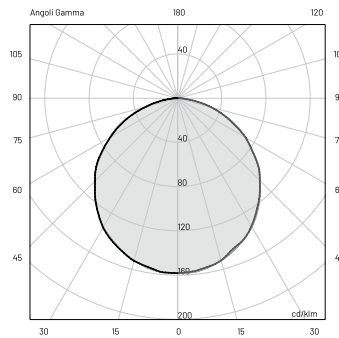

<sup>1</sup> all the technical specifications are related to one head only

## MATERIALS

|           |  |
|-----------|--|
| Body      | Die-cast aluminum EN47100<br>and extruded aluminum EN AW6060 |
| Diffuser  | Opal polycarbonate   |
| Finishing | Polyester powder paint                                       |

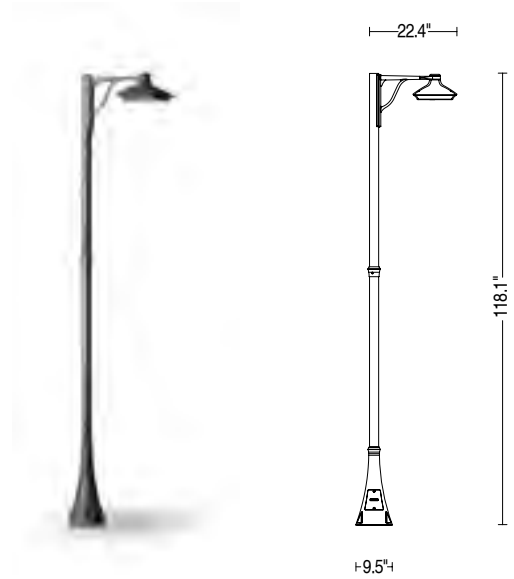

## ORDER CODE

MO 4 2 \_ \_ D \_ B D Z \_

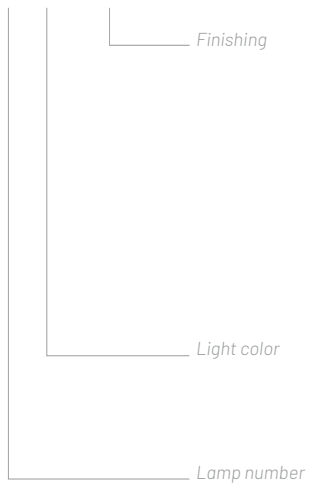

|            |              |   |
|------------|--------------|---|
| <b>G</b>   | Black        | ● |
| <b>S</b>   | Black/copper | ● |
| <b>P</b>   | Black/green  | ● |
| <b>R</b>   | Black/silver | ● |
| <b>L</b>   | Graphite     | ● |
| <b>V</b>   | Oxide        | ● |
| <b>N</b>   | 4000K        |   |
| <b>H</b>   | 3000K        |   |
| <b>PA1</b> | 1 lamp       |   |
| <b>PA2</b> | 2 lamps      |   |
| <b>PA3</b> | 3 lamps      |   |

Example

**MO 4 2 PA1 D N B D Z L**



## AVAILABLE ACCESSORIES

| Code       | Description           |
|------------|-----------------------|
| 00A170.01P | Anchor bolt           |
| 0404M003   | Loop-in loop-out IP68 |





