

Classicism and technology.

morphis

design by Innocenzo Rifino & Lorenzo Ruggieri

designplanTM 

79 Trenton Avenue
Frenchtown, NJ 08825

www.designplan.com

Tel: (908) 996-7710
Fax: (908) 996-7042





morphis_1

Morphis_1 has the shape of the old lanterns, typical of the traditional outdoor lighting: a classical design in a contemporary key. A diffused light and an extra clear polycarbonate screen. A 29W luminaire ideal for illuminating access roads and external paths, available with extruded aluminum pole of different heights and six powder-coated finish options.

MORPHIS_1 | WALL LAMP
MORPHIS_2 | WALL LAMP
MORPHIS_3 | WALL LAMP
MORPHIS_3 | PENDANT
MORPHIS_1 | BOLLARD





morphis_1

DIFFUSE

29W



TECHNICAL SPECIFICATIONS

| | DIFFUSE (HEAD ONLY) |
|-------------------|---|
| Source lamp | LED 29W |
| Total wattage | 33W |
| Voltage | xxx, 50-60 Hz |
| Control | On/Off • dimmable on request |
| Light color | 3000K • 4000K • other colors on request |
| Delivered lumens | 1700 lm (3400 lm*) @ 3000K |
| *Source lumens | 1800 lm (3600 lm*) @ 4000K |
| Luminous efficacy | 48 lm/W @ 3000K 52 lm/W @ 4000K |
| McADAM steps | 3 |
| Beam | Diffuse |
| CRI | > 90 |
| Life time | L70 > 50.000 h Ta 40°C |
| IP rating | IP65 |
| IK rating | IK08 |

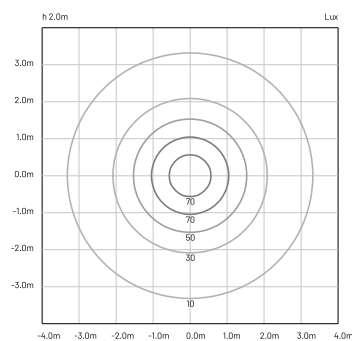
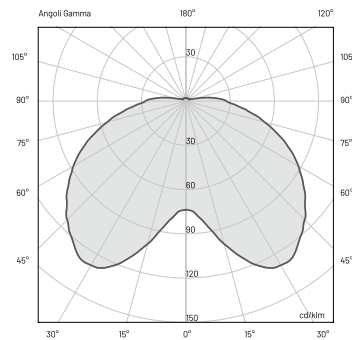

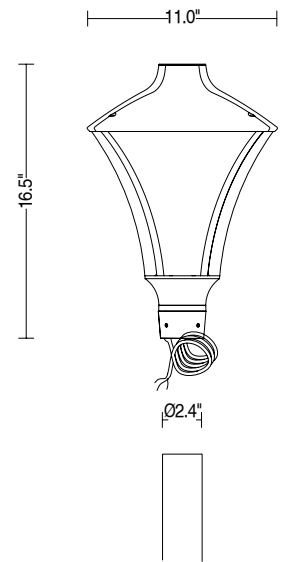







MATERIALS

| | |
|-----------|---|
| Body | Die-cast aluminum EN47100 and extruded aluminum EN AW6060 |
| Diffuser | Extra clear polycarbonate |
| Finishing | Polyester powder paint |

ORDER CODE

MO 4 0 PAT D _ B 10 _

| | | | |
|--------------------|------------------------------|--------------|---|
| <i>Finishing</i> | G | Black |  |
| | S | Black/copper |  |
| | P | Black/green |  |
| | R | Black/silver |  |
| | L | Graphite |  |
| | V | Oxide |  |
| <i>Light color</i> | N | 4000K | |
| | H | 3000K | |
| <i>Example</i> | MO 4 0 PAT D N B 10 L | | |



INCLUDED ACCESSORIES

| Code | Description | Page |
|------|----------------------------|------|
| - | 6.56' length cable -05RN-F | - |

morphis_1

DIFFUSE

29W



TECHNICAL SPECIFICATIONS

| | DIFFUSE |
|------------------------------------|--|
| Source lamp | LED 29W |
| Total wattage | 33W |
| Voltage | xxx, 50-60 Hz |
| Control | On/Off • dimmable on request |
| Light color | 3000K • 4000K • other colors on request |
| Delivered lumens *Source lumens | 1700 lm (3400 lm*) @ 3000K 1800 lm (3600 lm*) @ 4000K |
| Luminous efficacy | 48 lm/W @ 3000K 52 lm/W @ 4000K |
| McADAM steps | 3 |
| Beam | Diffuse |
| CRI | > 90 |
| Life time | L70 > 50.000 h Ta 40°C |
| IP rating | IP65 |
| IK rating | IK08 |

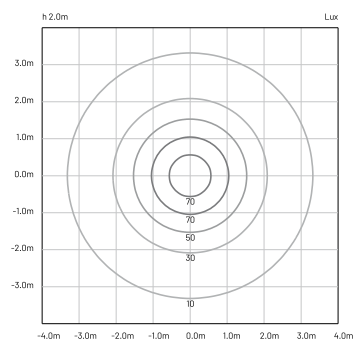
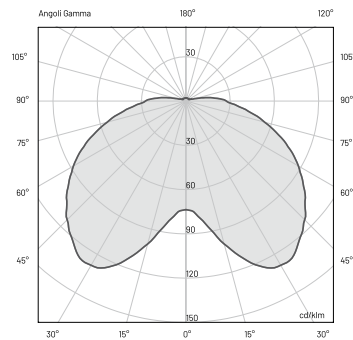

MATERIALS

| | |
|-----------|--|
| Body | Die-cast aluminum EN47100 and extruded aluminum EN AW6060 |
| Diffuser | Extra clear polycarbonate |
| Finishing | Polyester powder paint |

ORDER CODE

MO 4 0 _ _ _ D _ B 1 0 _

| | | | |
|-------------|------------------------|--------------|---|
| Finishing | G | Black | ● |
| | S | Black/copper | ● |
| | P | Black/green | ● |
| | R | Black/silver | ● |
| | L | Graphite | ● |
| | V | Oxide | ● |
| Light color | N | 4000K | |
| | H | 3000K | |
| Height | 180 | 70.08" | |
| | 200 | 78.74" | |
| | 300 | 118.50" | |
| Example | MO 4 0 180 D N B 1 0 L | | |

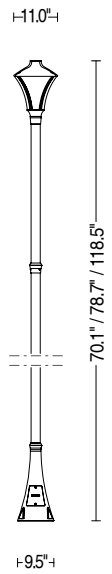

AVAILABLE ACCESSORIES

| Code | Description |
|------------|-----------------------|
| 00A170.01P | Anchor bolt |
| 0404M003 | Loop-in loop-out IP68 |





morphis_2

A design inspired by the classic of classics for Morphis_2. A diffused light with extra clear transparent polycarbonate screen for a pole head that can be installed at a height of 129.92" and available in single, double or triple solution. 29W power and six finishing options, for any type of home or external public access.

MORPHIS_1 | WALL LAMP
MORPHIS_2 | WALL LAMP
MORPHIS_3 | WALL LAMP
MORPHIS_3 | PENDANT
MORPHIS_1 | BOLLARD





morphis_2

1, 2, 3 LAMPS DIFFUSE

29W



TECHNICAL SPECIFICATIONS ¹

| | DIFFUSE |
|------------------------------------|--|
| Source lamp | LED 29W |
| Total wattage | 33W |
| Voltage | xxx, 50-60 Hz |
| Control | On/Off • dimmable on request |
| Light color | 3000K • 4000K • other colors on request |
| Delivered lumens *Source lumens | 1700 lm (3400 lm*) @ 3000K 1800 lm (3600 lm*) @ 4000K |
| Luminous efficacy | 48 lm/W @ 3000K 52 lm/W @ 4000K |
| McADAM steps | 3 |
| Beam | Diffuse |
| CRI | > 90 |
| Life time | L70 > 50.000 h Ta 40°C |
| IP rating | IP65 |
| IK rating | IK08 |

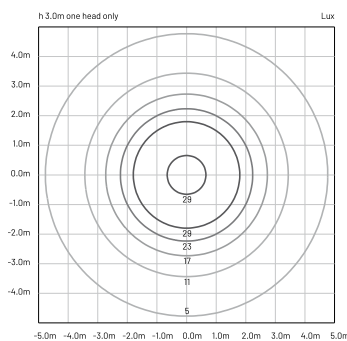
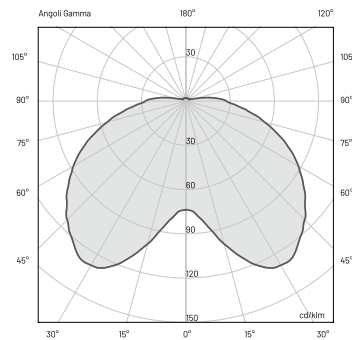

¹ all the technical specifications are related to one head only

MATERIALS

| | |
|-----------|--|
| Body | Die-cast aluminum EN47100 and extruded aluminum EN AW6060 |
| Diffuser | Extra clear polycarbonate |
| Finishing | Polyester powder paint |

ORDER CODE

MO 4 0 _ _ _ D _ B 1 0 _

| | | | |
|-------------|-----|--------------|---|
| Finishing | G | Black | ● |
| | S | Black/copper | ● |
| | P | Black/green | ● |
| | R | Black/silver | ● |
| | L | Graphite | ● |
| | V | Oxide | ● |
| Light color | N | 4000K | |
| | H | 3000K | |
| Lamp number | PA1 | 1 lamp | |
| | PA2 | 2 lamps | |
| | PA3 | 3 lamps | |

Example MO 4 0 PA1 D N B 1 0 L

AVAILABLE ACCESSORIES

| Code | Description |
|------------|-----------------------|
| 00A170.01P | Anchor bolt |
| 0404M003 | Loop-in loop-out IP68 |

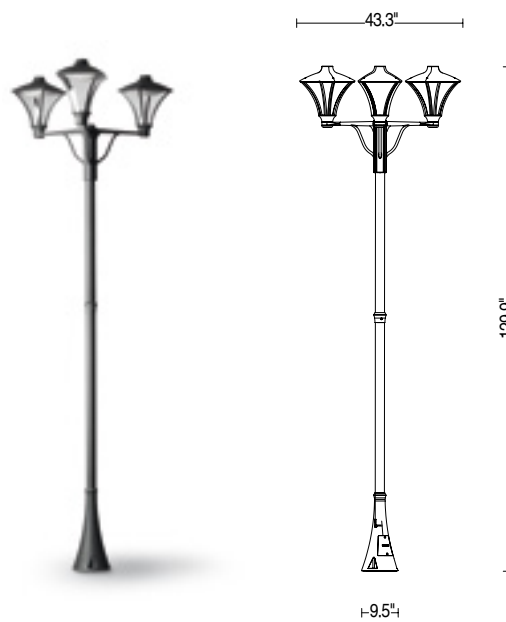
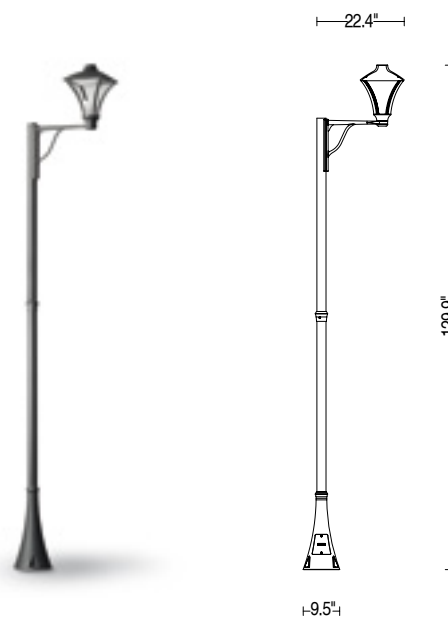

morphis_3

Morphis_3 is a perfect combination of classic and contemporary.

Traditional design and innovative technology: 29W power, diffused optics and extra-clear polycarbonate. The six finishing options, the three installation solutions, single, double or triple on 118.1" pole, and the robustness of the construction components make Morphis_3 a strong, versatile luminaire compatible with any outdoor type for the residential sector.

MORPHIS_1 | WALL LAMP
MORPHIS_2 | WALL LAMP
MORPHIS_3 | WALL LAMP
MORPHIS_3 | PENDANT
MORPHIS_1 | BOLLARD





morphis_3

1, 2, 3 LAMPS DIFFUSE

29W



TECHNICAL SPECIFICATIONS ¹

| | DIFFUSE |
|------------------------------------|--|
| Source lamp | LED 29W |
| Total wattage | 33W |
| Voltage | xxx, 50-60 Hz |
| Control | On/Off • dimmable on request |
| Light color | 3000K • 4000K • other colors on request |
| Delivered lumens *Source lumens | 1700 lm (3400 lm*) @ 3000K 1800 lm (3600 lm*) @ 4000K |
| Luminous efficacy | 48 lm/W @ 3000K 52 lm/W @ 4000K |
| McADAM steps | 3 |
| Beam | Diffuse |
| CRI | > 90 |
| Life time | L70 > 50.000 h Ta 40°C |
| IP rating | IP65 |
| IK rating | IK08 |

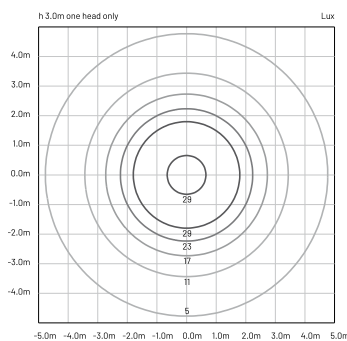
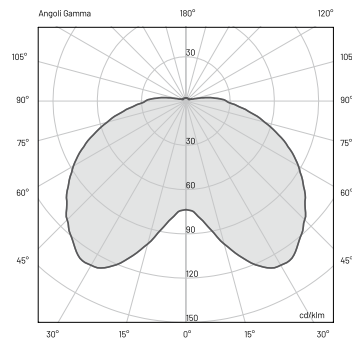

¹ all the technical specifications are related to one head only

MATERIALS

| | |
|-----------|--|
| Body | Die-cast aluminum EN47100 and extruded aluminum EN AW6060 |
| Diffuser | Extra clear polycarbonate |
| Finishing | Polyester powder paint |

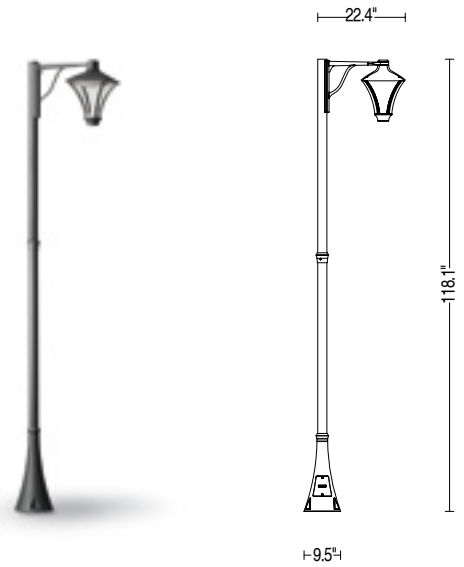

ORDER CODE

M0 4 1 _ _ _ D _ B 1 0 _

| | | | |
|-------------|-----|--------------|---|
| Finishing | G | Black | ● |
| | S | Black/copper | ● |
| | P | Black/green | ● |
| | R | Black/silver | ● |
| | L | Graphite | ● |
| | V | Oxide | ● |
| Light color | N | 4000K | |
| | H | 3000K | |
| Lamp number | PA1 | 1 lamp | |
| | PA2 | 2 lamps | |
| | PA3 | 3 lamps | |

Example M0 4 1 PA1 D N B 1 0 L

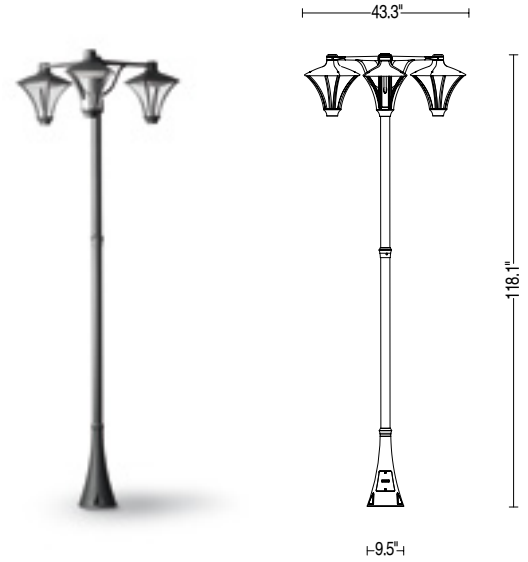

AVAILABLE ACCESSORIES

| Code | Description |
|------------|-----------------------|
| 00A170.01P | Anchor bolt |
| 0404M003 | Loop-in loop-out IP68 |





morphis_4

Morphis_4 is an exclusive and additional variant of the range where the lantern has a compact design to favor discretion. A compact pole head with diffuse optics which can be installed at a height of 118.1" in single, double or triple version. Morphis_4 is the perfect solution for lighting gardens, access roads and outdoor paths of all types and designs. Six powder finishes are available to the designer to meet any specific need for customization.

MORPHIS_4 | WALL LAMP
MORPHIS_4 | CEILING LAMP
MORPHIS_4 | PENDANT





morphis_4

1, 2, 3 LAMPS DIFFUSE

29W



TECHNICAL SPECIFICATIONS ¹

| | DIFFUSE |
|-------------------|---|
| Source lamp | LED 29W |
| Total wattage | 33W |
| Voltage | 700mA, 50-60 Hz |
| Control | On/Off • dimmable on request |
| Light color | 3000K • 4000K • other colors on request |
| Delivered lumens | 1550 lm (3400 lm*) @ 3000K |
| *Source lumens | 1650 lm (3600 lm*) @ 4000K |
| Luminous efficacy | 44 lm/W @ 3000K 47 lm/W @ 4000K |
| McADAM steps | 3 |
| Beam | Diffuse |
| CRI | > 90 |
| Life time | L70 > 50.000 h Ta 40°C |
| IP rating | IP65 |
| IK rating | IK08 |

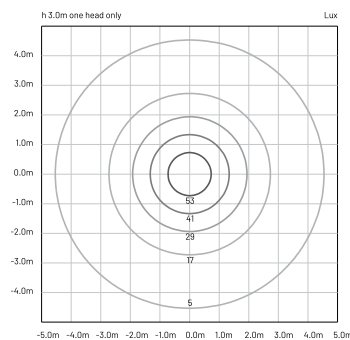
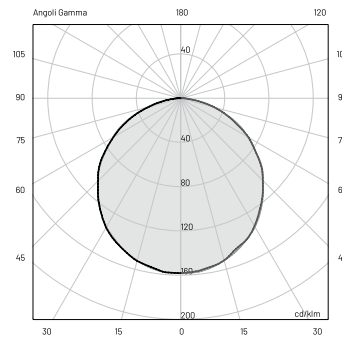

¹ all the technical specifications are related to one head only

MATERIALS

| | |
|-----------|--|
| Body | Die-cast aluminum EN47100 and extruded aluminum EN AW6060 |
| Diffuser | Opal polycarbonate |
| Finishing | Polyester powder paint |

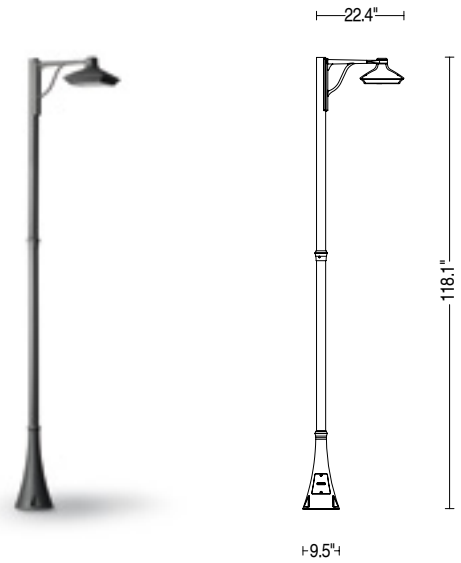

ORDER CODE

MO 4 2 _ _ _ D _ B 1 0 _

| | | | |
|-------------|-----|--------------|---|
| Finishing | G | Black | ● |
| | S | Black/copper | ● |
| | P | Black/green | ● |
| | R | Black/silver | ● |
| | L | Graphite | ● |
| | V | Oxide | ● |
| Light color | N | 4000K | |
| | H | 3000K | |
| Lamp number | PA1 | 1 lamp | |
| | PA2 | 2 lamps | |
| | PA3 | 3 lamps | |

Example MO 4 2 PA1 D N B 1 0 L

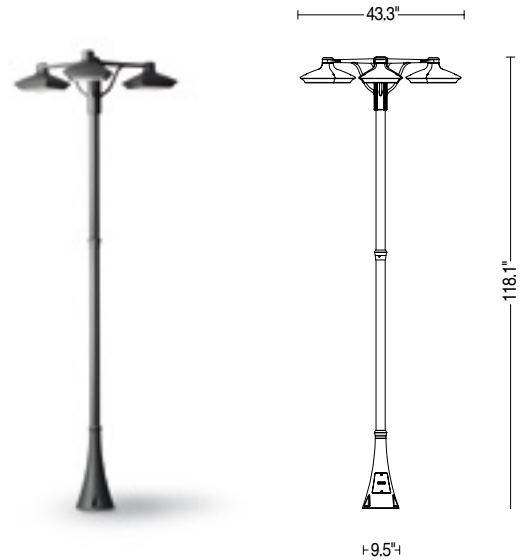

AVAILABLE ACCESSORIES

| Code | Description |
|------------|-----------------------|
| 00A170.01P | Anchor bolt |
| 0404M003 | Loop-in loop-out IP68 |



