

BENTH T-100

Benth is a small, IP65-rated, LED floodlight on a slim but durable stem, with 110° adjustability to orient the light beam for a variety of needs. It is available in 3 heights, 2 optic options, and 3 Hard Coated Treatment finishes (see below). Can be installed on a mounting plate or spike. Dark Sky compliant for output below 80°.

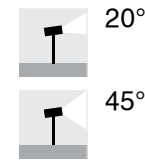

Fixture Dimensions - See page 2

TECHNICAL DATA

Wattage / Input	5W
Power Supply	Remote 350mA, not included. See page 2
Dimming	See Power Supplies on page 2
Construction	Body: AISI 316L Stainless Steel Lens: Transparent Polycarbonate
CCT	2700K, 3000K, 4000K
CRI	>80
Delivered Lumens	325 lm (3000K) Dark Sky compliant, output below 80°
Efficacy	65 lm/W (3000K)
Optics	20°, 45° (Adjustable 110°)
BUG Rating	—
Lumen Maintenance	100,000 hrs L80, B10 (Ta 25°C)
Hard Coat Finishes	Inox Natural, Inox Graphite, Inox Bronze
Fixture Dimensions	Head: 3.94" l x 1.18" Heights: 7.87", 15.75", 31.50"
IP Rating	IP65
Impact Resistance	IK07
Warranty	10 Years Against Corrosion 5 Years on Electrical Components

Hard Coating Treatment is the surface treatment of all the products by Stral Lighting. It is not a skin of color, but instead is a process that allows for the color to be absorbed all the way through. If a product is scratched, the color beneath is the same as the color on the surface. It guarantees a high superficial resistance to corrosion and atmospheric agents, as well as making the products anti-fingerprint and anti-stain. Available in three finishes Inox Natural, Inox Graphite and Inox Bronze.

ORDERING INFORMATION

Example: SPT5034034BS.US. Power Supplies / Accessories sold separately.

SPT503						.US
Model No.	Height	CCT	Optics	Finishes	Fixing	
SPT503	20 - 7.87"	2 - 2700K	2 - 20°	N - Inox Natural	F - On Flange Mount Plate	.US
	40 - 15.75"	3 - 3000K	4 - 45°	G - Inox Graphite	S - On Spike	
	80 - 31.50"	4 - 4000K		B - Inox Bronze	See Accessories page for ordering numbers	

Job Name/Date:

Fixture Type Designation:

FIXTURE DIMENSIONS

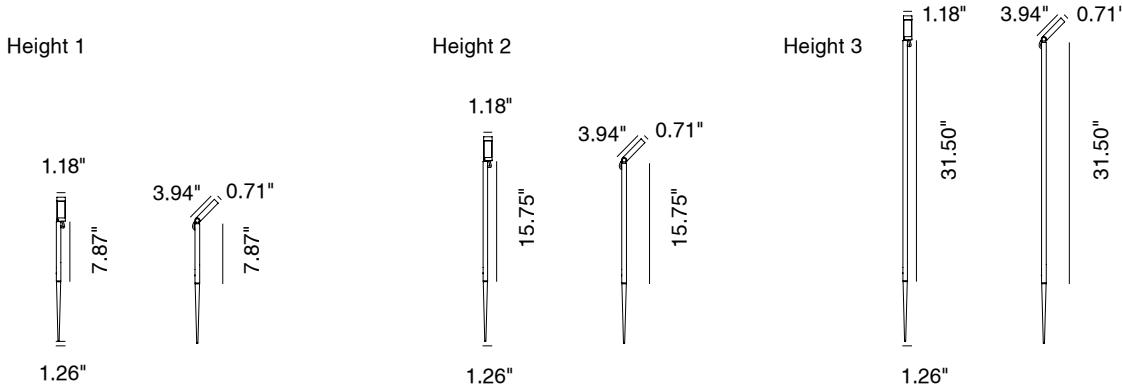

SUGGESTED POWER SUPPLIES

350mA

Part Number	Description	Input/Output	# of Fixtures
PPLT00148	0-10V Dimming to 10%	120-277VAC to 350mA, 6W, Class 2	1-1
PPLT00496	Phase Dim (120V only)	120VAC to 350mA, 12W, Class 2, DAMP	1-2
PPLT00263	Leading / Trailing Edge Dimming to 10% (120V only)	120-277VAC to 350mA, 32W, Class 2	2-3
PPLT00467-P	0-10V Dimming to 1.0%	120-277VAC to 350mA, 50W, Class 2, DAMP	1-4
PPLT00538-P	0-10V Dimming to 0.1% (4 channels)	120-277VAC to 350mA, 100W, Class 2	1-4 (1-16)

Suggested Lutron Compatible

Part Number	Option	Lutron SKU	Dim Range	Description	Input/Output	# of Fixtures
PPLT00247	L3DAE / L3DA3W	L3DA	100%-1%	Hi-Lume™ 1% EcoSystem™ or 1% 3-Wire LED Driver	120-277VAC to 350mA, 7W, Class 2	1-1
PPLT00516	L3DAE / L3DA3W	L3DA	100%-1%	Hi-Lume™ 1% EcoSystem™ or 1% 3-Wire LED Driver	120-277VAC to 350mA, 13W, Class 2	2-2
PPLT00179	L3DAE / L3DA3W	L3DA	100%-1%	Hi-Lume™ 1% EcoSystem™ or 1% 3-Wire LED Driver	120-277VAC to 350mA, 19W, Class 2	3-4

For other power supply options consult factory.

FINISHES



Inox Natural

Inox Graphite

Inox Bronze

Job Name/Date:

Fixture Type Designation:

ACCESSORIES

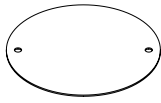

PT40002
Mortar Cap
Ø4.33"

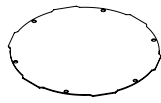

PT40003
Bottom Cap
Ø6.30"



PT69001
Spike
Ø0.79" x 1.97" w x 9.45" h

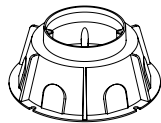

PT52123
Casing
Ø7.87" x 7.87" w x 3.15" h

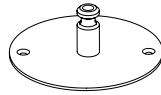

PT68100
Casing Flange
Ø4.33" x 4.33" w x 1.57" h

PHOTOMETRIC DATA

Note: All photometric data is 3000K

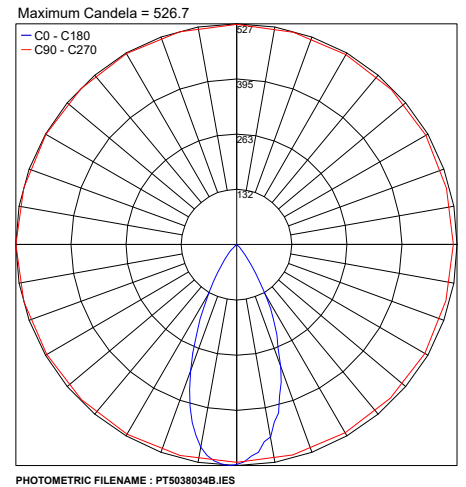
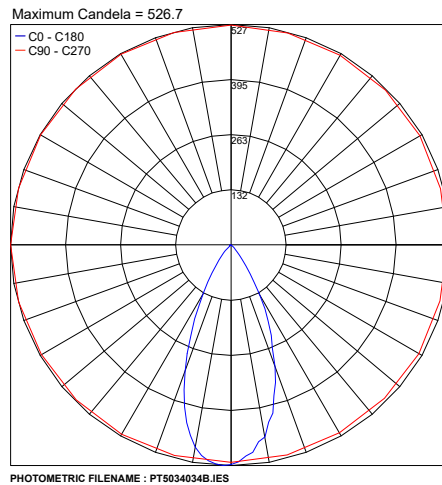
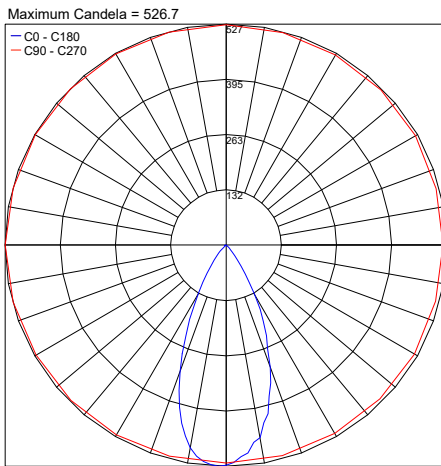

Job Name/Date:

Fixture Type Designation: