

# DAN M-120

Dan is an IP66-rated stainless steel bollard with clean lines and harmonious proportions that is perfectly suited for illuminating gardens and paths. It is available in 2 heights (23.6" or 35.4"), 2 pole head diameters (3.5" or 4.7"), and 3 standard Hard Coat Treatment finishes. Dan M-90 is the 7W, 4.7" pole head version. Flange with anchor bolts available for installation in concrete.



M120



## TECHNICAL DATA

<b>Wattage / Input</b>	7W (DAN M120)
<b>Power Supply</b>	Integral 120VAC
<b>Dimming</b>	On/Off Only
<b>Construction</b>	Body: AISI 316L Stainless Steel Lens: Black Silk-screened Extra-clear Tempered Glass 0.2" Thick
<b>CCT</b>	2700K, 3000K, 4000K
<b>CRI</b>	>85
<b>BUG Rating</b>	B0-U1-G0 (3000K)
<b>Delivered Lumens</b>	750 lm (M120 version - 3000K)
<b>Efficacy</b>	107 lm/W (M120 version - 3000K)
<b>Optics</b>	21°, 45°, 65°
<b>Lumen Maintenance</b>	100,000 hrs L80, B10 (Ta 25°C)
<b>Hard Coat Finishes</b>	Inox Natural, Inox Graphite, Inox Bronze
<b>Fixture Dimensions</b>	M120: 4.72" x 7.01" x 23.62" or 35.73" h
<b>IP Rating</b>	IP66
<b>Impact Resistance</b>	IK08
<b>Warranty</b>	10 Years Against Corrosion 5 Years on Electrical Components

## Fixture Dimensions

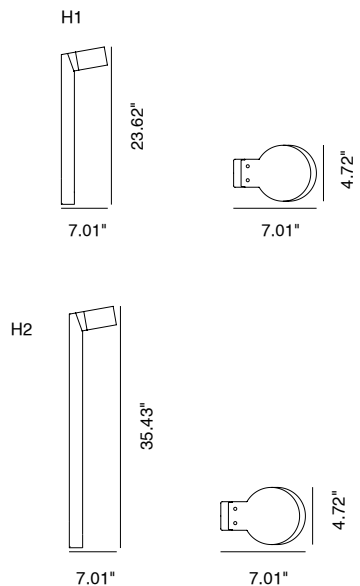

**Hard Coating Treatment** is the surface treatment of all the products by Stral Lighting. It is not a skin of color, but instead is a process that allows for the color to be absorbed all the way through. If a product is scratched, the color beneath is the same as the color on the surface. It guarantees a high superficial resistance to corrosion and atmospheric agents, as well as making the products anti-fingerprint and anti-stain. Available in three finishes Inox Natural, Inox Graphite and Inox Bronze.

## ORDERING INFORMATION

Example: SPT6022349B.US. Accessories sold separately.

SPT6022					.US
Model No.	CCT	Optics	Height	Finishes	
SPT6022 (M120)	2 - 2700K 3 - 3000K 4 - 4000K	2 - 21° 4 - 45° 6 - 65°	6 - 23.6" height 9 - 35.4" height	N - Inox Natural G - Inox Graphite B - Inox Bronze	.US

Job Name/Date:

Fixture Type Designation:

## FINISHES



Inox Natural



Inox Graphite



Inox Bronze

## ACCESSORIES

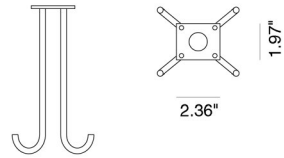

**PT64000**  
Flange with 4 Anchor Bolts  
for DAN  
**(REQUIRED)**

## PHOTOMETRIC DATA

Note: All photometric data is 3000K

24 inch version

Maximum Candela = 2697.9

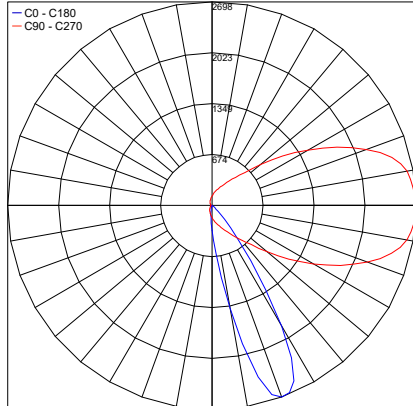

PHOTOMETRIC FILENAME : DAN M-120 - 24IN 7W 30K 21° - PT6022326N.IES

Maximum Candela = 525.6

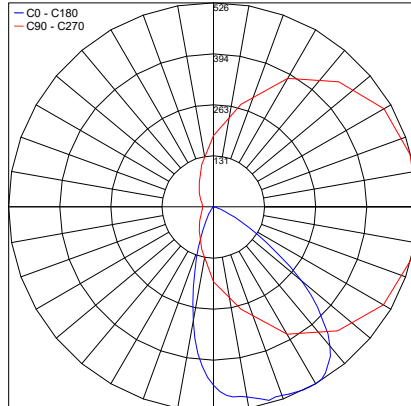

PHOTOMETRIC FILENAME : DAN M-120 - 24IN 7W 30K 65° - PT6022366N.IES

35 inch version

Maximum Candela = 2697.9

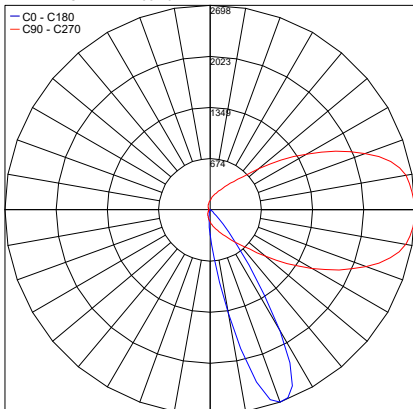

PHOTOMETRIC FILENAME : DAN M-120 - 35IN 7W 30K 21° - PT6022329N.IES

Maximum Candela = 912.4

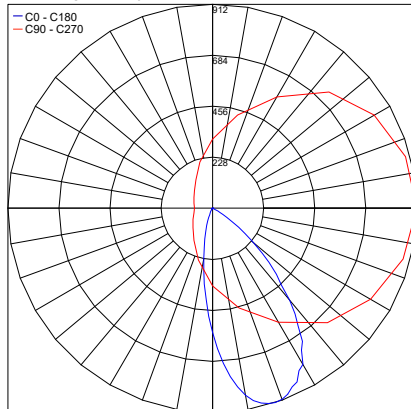

PHOTOMETRIC FILENAME : DAN M-120 - 35IN 7W 30K 45° - PT6022349N.IES

Maximum Candela = 525.6

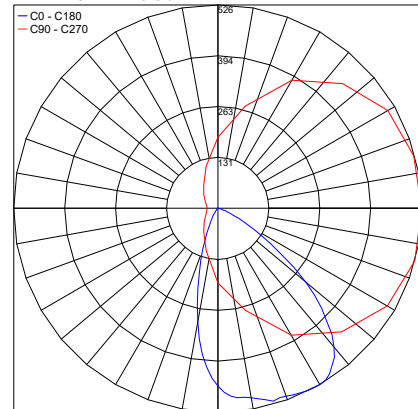

PHOTOMETRIC FILENAME : DAN M-120 - 35IN 7W 30K 65° - PT6022369N.IES

Job Name/Date:

Fixture Type Designation: