

Dan is an IP66-rated stainless steel bollard with clean lines and harmonious proportions that is perfectly suited for illuminating gardens and paths. It is available in 2 heights (23.6" or 35.4"), 2 pole head diameters (3.5" or 4.7"), and 3 standard Hard Coat Treatment finishes. Dan M-90 is the 5W, 3.5" pole head version. Flange with anchor bolts available for installation in concrete.



M-90

TECHNICAL DATA

Wattage / Input	5W (DAN M-90)
Power Supply	Integral 120VAC
Dimming	On/Off Only
Construction	Body: AISI 316L Stainless Steel Lens: Black Silk-screened Extra-clear Tempered Glass 0.2" Thick
CCT	2700K, 3000K, 4000K
CRI	>85
BUG Rating	B0-U1-G0 (3000K)
Delivered Lumens	550 lm (M-90 version - 3000K)
Efficacy	110 lm/W (M-90 version - 3000K)
Optics	21°, 45°, 65°
Lumen Maintenance	100,000 hrs L80, B10 (Ta 25°C)
Hard Coat Finishes	Inox Natural, Inox Graphite, Inox Bronze
Fixture Dimensions	3.54" x 5.71" x 23.62" or 35.73" h
IP Rating	IP66
Impact Resistance	IK08
Warranty	10 Years Against Corrosion 5 Years on Electrical Components

Fixture Dimensions

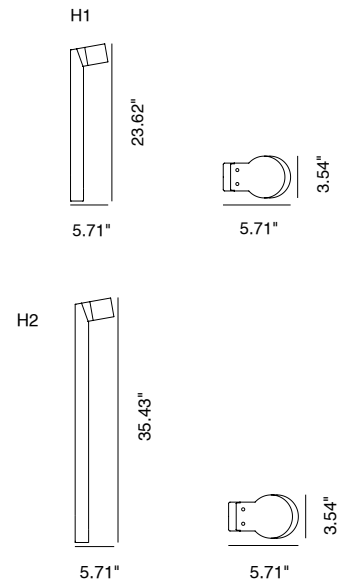

Hard Coating Treatment is the surface treatment of all the products by Stral Lighting. It is not a skin of color, but instead is a process that allows for the color to be absorbed all the way through. If a product is scratched, the color beneath is the same as the color on the surface. It guarantees a high superficial resistance to corrosion and atmospheric agents, as well as making the products anti-fingerprint and anti-stain. Available in three finishes Inox Natural, Inox Graphite and Inox Bronze.

ORDERING INFORMATION

Example: SPT6021349B.US. Accessories sold separately.

SPT6021					.US
Model No.	CCT	Optics	Height	Finishes	
SPT6021 (M-90)	2 - 2700K 3 - 3000K 4 - 4000K	2 - 21° 4 - 45° 6 - 65°	6 - 23.6" height 9 - 35.4" height	N - Inox Natural G - Inox Graphite B - Inox Bronze	.US

Job Name/Date:

Fixture Type Designation:

FINISHES



Inox Natural



Inox Graphite



Inox Bronze

ACCESSORIES

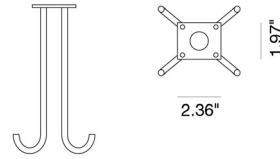

PT64000

Flange with 4 Anchor Bolts
for DAN
(REQUIRED)

PHOTOMETRIC DATA

Note: All photometric data is 3000K

24 inch version

Maximum Candela = 1993.5

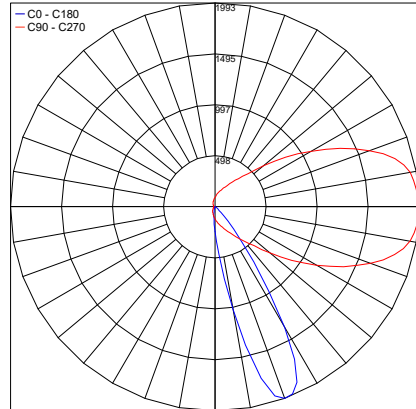

PHOTOMETRIC FILENAME : DAN M-90 - 24IN SW 30K 21° - PT6021326N.IES

Maximum Candela = 674.2

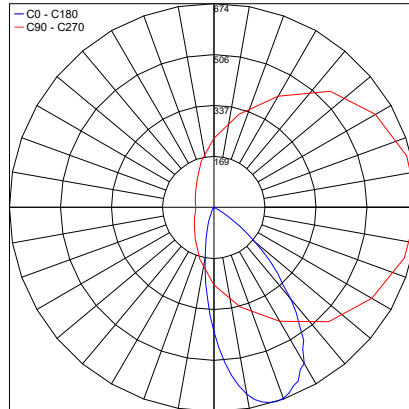

PHOTOMETRIC FILENAME : DAN M-90 - 24IN SW 30K 45° - PT6021346N.IES

Maximum Candela = 388.3

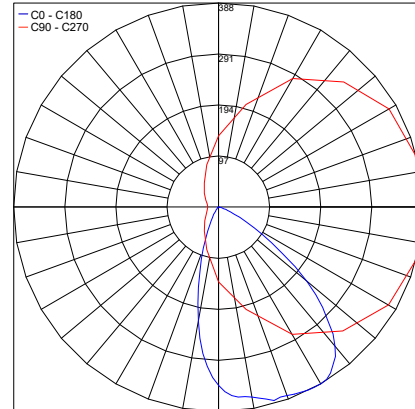

PHOTOMETRIC FILENAME : DAN M-90 - 24IN SW 30K 65° - PT6021366N.IES

35 inch version

Maximum Candela = 1993.5

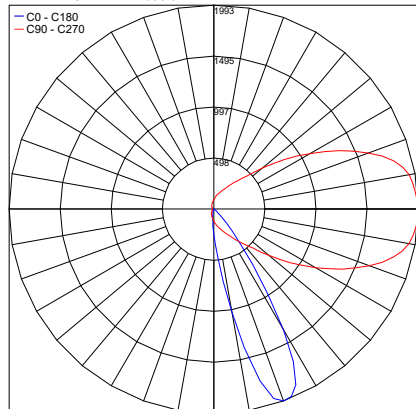

PHOTOMETRIC FILENAME : DAN M-90 - 35IN SW 30K 21° - PT6021329N.IES

Maximum Candela = 674.2

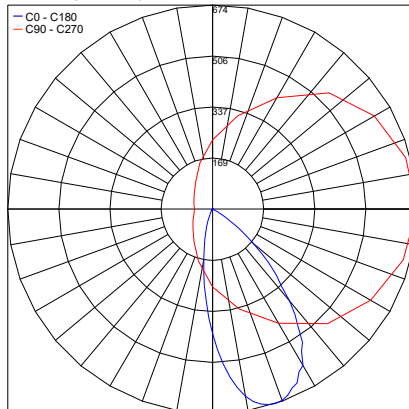

PHOTOMETRIC FILENAME : DAN M-90 - 35IN SW 30K 45° - PT6021349N.IES

Maximum Candela = 388.3

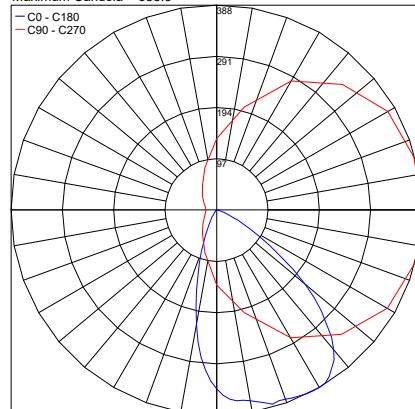

PHOTOMETRIC FILENAME : DAN M-90 - 35IN SW 30K 65° - PT6021369N.IES

Job Name/Date:

Fixture Type Designation: