

# DAN M-90

Dan is an IP66-rated stainless steel bollard with clean lines and harmonious proportions that is perfectly suited for illuminating gardens and paths. It is available in 2 heights (23.6" or 35.4"), 2 pole head diameters (3.5" or 4.7"), and 3 standard Hard Coat Treatment finishes. Dan M-90 is the 5W, 3.5" pole head version. Flange with anchor bolts available for installation in concrete. Dark Sky compliant for output below 80°.



M-90

## TECHNICAL DATA

<b>Wattage / Input</b>	5W (DAN M-90)
<b>Power Supply</b>	Integral 120VAC
<b>Dimming</b>	On/Off Only
<b>Construction</b>	Body: AISI 316L Stainless Steel Lens: Black Silk-screened Extra-clear Tempered Glass 0.2" Thick
<b>CCT</b>	2700K, 3000K, 4000K
<b>CRI</b>	>85
<b>BUG Rating</b>	B0-U1-G0 (3000K)
<b>Delivered Lumens</b>	550 lm (M-90 version - 3000K) Dark Sky compliant, output below 80°
<b>Efficacy</b>	110 lm/W (M-90 version - 3000K)
<b>Optics</b>	21°, 45°, 65°
<b>Lumen Maintenance</b>	100,000 hrs L80, B10 (Ta 25°C)
<b>Hard Coat Finishes</b>	Inox Natural, Inox Graphite, Inox Bronze
<b>Fixture Dimensions</b>	3.54" x 5.71" x 23.62" or 35.73" h
<b>IP Rating</b>	IP66
<b>Impact Resistance</b>	IK08
<b>Warranty</b>	10 Years Against Corrosion 5 Years on Electrical Components

## Fixture Dimensions

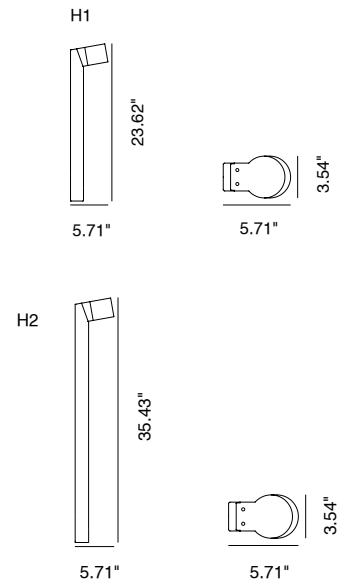

**Hard Coating Treatment** is the surface treatment of all the products by Stral Lighting. It is not a skin of color, but instead is a process that allows for the color to be absorbed all the way through. If a product is scratched, the color beneath is the same as the color on the surface. It guarantees a high superficial resistance to corrosion and atmospheric agents, as well as making the products anti-fingerprint and anti-stain. Available in three finishes Inox Natural, Inox Graphite and Inox Bronze.

## ORDERING INFORMATION

Example: SPT6021349B.US. Accessories sold separately.

SPT6021					.US
<b>Model No.</b>	<b>CCT</b>	<b>Optics</b>	<b>Height</b>	<b>Finishes</b>	
SPT6021 (M-90)	2 - 2700K 3 - 3000K 4 - 4000K	2 - 21° 4 - 45° 6 - 65°	6 - 23.6" height 9 - 35.4" height	N - Inox Natural G - Inox Graphite B - Inox Bronze	.US

Job Name/Date:

Fixture Type Designation:

## FINISHES



Inox Natural



Inox Graphite



Inox Bronze

## ACCESSORIES

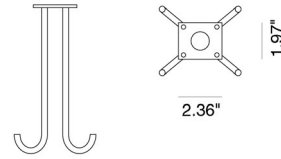

### PT64000

Flange with 4 Anchor Bolts  
for DAN  
**(REQUIRED)**

## PHOTOMETRIC DATA

Note: All photometric data is 3000K

### 24 inch version

Maximum Candela = 1993.5

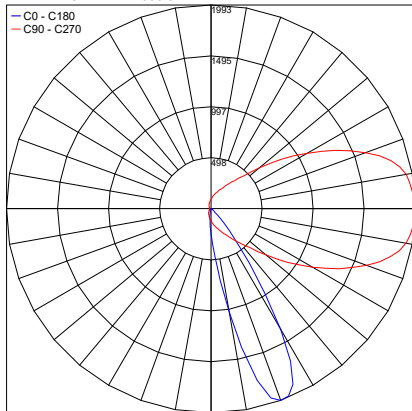

PHOTOMETRIC FILENAME : DAN M-90 - 24IN SW 30K 21° - PT6021326N.IES

Maximum Candela = 674.2

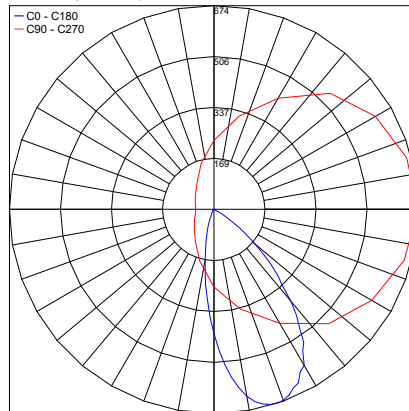

PHOTOMETRIC FILENAME : DAN M-90 - 24IN SW 30K 45° - PT6021346N.IES

Maximum Candela = 388.3

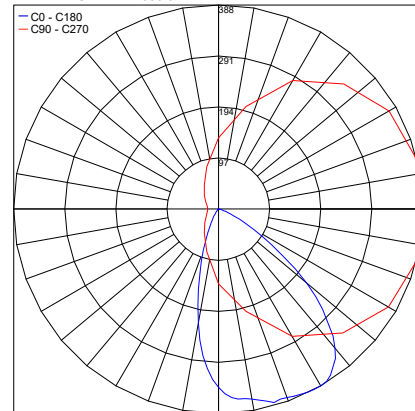

PHOTOMETRIC FILENAME : DAN M-90 - 24IN SW 30K 65° - PT6021366N.IES

### 35 inch version

Maximum Candela = 1993.5

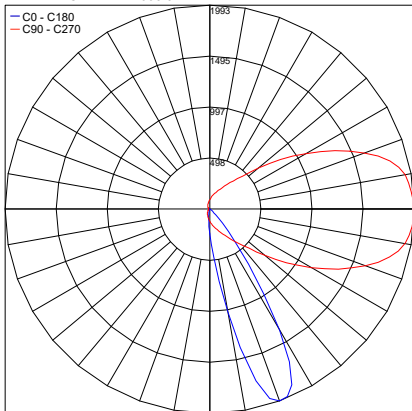

PHOTOMETRIC FILENAME : DAN M-90 - 35IN SW 30K 21° - PT6021329N.IES

Maximum Candela = 674.2

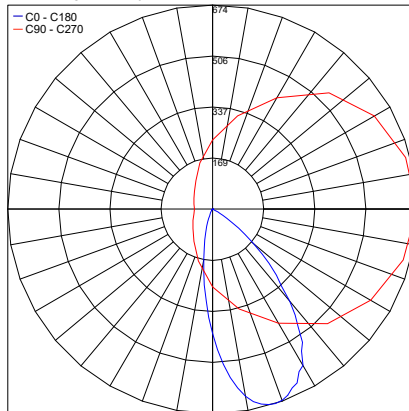

PHOTOMETRIC FILENAME : DAN M-90 - 35IN SW 30K 45° - PT6021349N.IES

Maximum Candela = 388.3

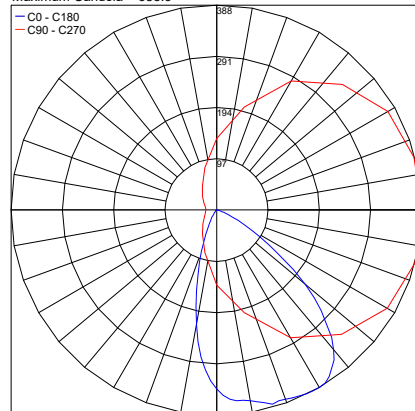

PHOTOMETRIC FILENAME : DAN M-90 - 35IN SW 30K 65° - PT6021369N.IES

Job Name/Date:

Fixture Type Designation: