

Dan is an IP66-rated stainless steel bollard with clean lines and harmonious proportions that is perfectly suited for illuminating gardens and paths. It is available in 2 heights (23.6" or 35.4"), 2 pole head diameters (3.5" or 4.7"), and 3 standard Hard Coat Treatment finishes. Dan M-90 is the 5W, 3.5" pole head version. Flange with anchor bolts available for installation in concrete. Dark Sky compliant for output below 80°.

## TECHNICAL DATA

|                           |  |
|---------------------------|--|
| <b>Wattage / Input</b>    | 5W (DAN M-90)  |
| <b>Power Supply</b>       | Integral 120VAC  |
| <b>Dimming</b>            | On/Off Only  |
| <b>Construction</b>       | Body: AISI 316L Stainless Steel<br>Lens: Black Silk-screened Extra-clear Tempered Glass 0.2" Thick |
| <b>CCT</b>                | 2700K, 3000K, 4000K  |
| <b>CRI</b>                | >80  |
| <b>BUG Rating</b>         | B0-U1-G0 (3000K)   |
| <b>Delivered Lumens</b>   | 550 lm (M-90 version - 3000K)<br>Dark Sky compliant, output below 80°                              |
| <b>Efficacy</b>           | 110 lm/W (M-90 version - 3000K)  |
| <b>Optics</b>             | 21°, 45°, 65°  |
| <b>Lumen Maintenance</b>  | 100,000 hrs L80, B10 (Ta 25°C)   |
| <b>Hard Coat Finishes</b> | Inox Natural, Inox Graphite, Inox Bronze   |
| <b>Fixture Dimensions</b> | 3.54" x 5.71" x 23.62" or 35.73" h   |
| <b>IP Rating</b>          | IP66   |
| <b>Impact Resistance</b>  | IK08   |
| <b>Warranty</b>           | 10 Years Against Corrosion<br>5 Years on Electrical Components                                     |



M-90



## Fixture Dimensions

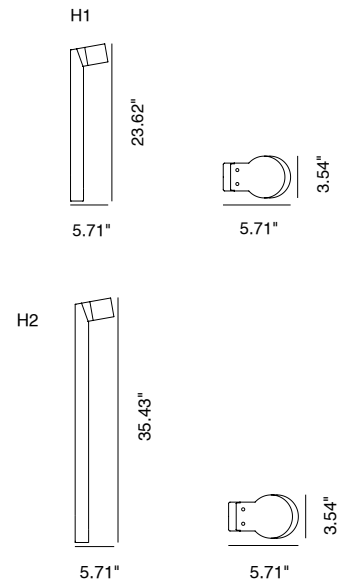

**Hard Coating Treatment** is the surface treatment of all the products by Stral Lighting. It is not a skin of color, but instead is a process that allows for the color to be absorbed all the way through. If a product is scratched, the color beneath is the same as the color on the surface. It guarantees a high superficial resistance to corrosion and atmospheric agents, as well as making the products anti-fingerprint and anti-stain. Available in three finishes Inox Natural, Inox Graphite and Inox Bronze.

## ORDERING INFORMATION

Example: SPT6021349B.US. Accessories sold separately.

| SPT6021        |                                     |                               |                                      |  | .US |
|----------------|-------------------------------------|-------------------------------|--------------------------------------|--|-----|
| Model No.      | CCT                                 | Optics                        | Height                               | Finishes   |     |
| SPT6021 (M-90) | 2 - 2700K<br>3 - 3000K<br>4 - 4000K | 2 - 21°<br>4 - 45°<br>6 - 65° | 6 - 23.6" height<br>9 - 35.4" height | N - Inox Natural<br>G - Inox Graphite<br>B - Inox Bronze | .US |

Job Name/Date:

Fixture Type Designation:

## FINISHES

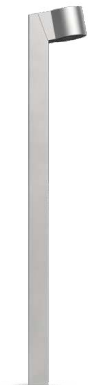

Inox Natural



Inox Graphite



Inox Bronze

## ACCESSORIES

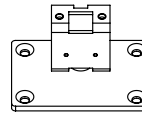

**PT64010**  
Anchor Flange  
4.13" w x 2.76" h  
**(REQUIRED)**

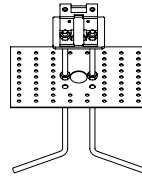

**PT64000**  
Anchor Bolts Kit  
(Set of 4)  
6.30" w x 10.63" h x 3.94" l  
**(REQUIRED)**

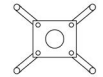
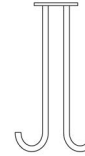

1.97"

2.36"

## PHOTOMETRIC DATA

Note: All photometric data is 3000K

24 inch version

Maximum Candela = 1993.5

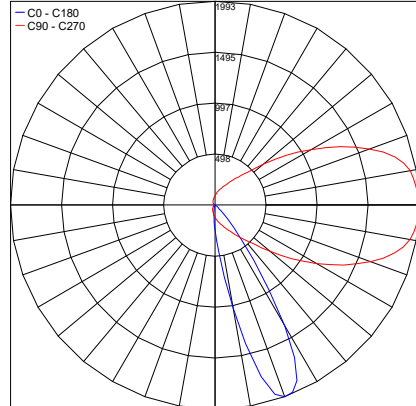

PHOTOMETRIC FILENAME : DAN M-90 - 24IN SW 30K 21° - PT6021326N.IES

Maximum Candela = 674.2

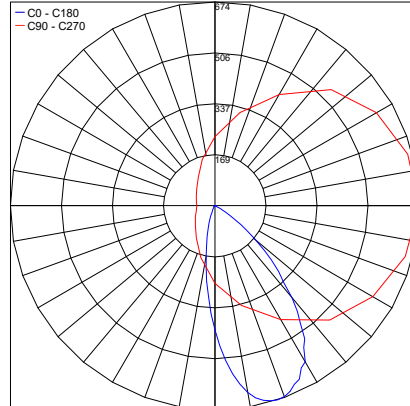

PHOTOMETRIC FILENAME : DAN M-90 - 24IN SW 30K 45° - PT6021346N.IES

Maximum Candela = 388.3

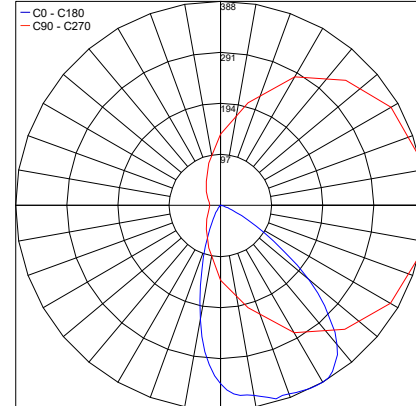

PHOTOMETRIC FILENAME : DAN M-90 - 24IN SW 30K 65° - PT6021366N.IES

35 inch version

Maximum Candela = 1993.5

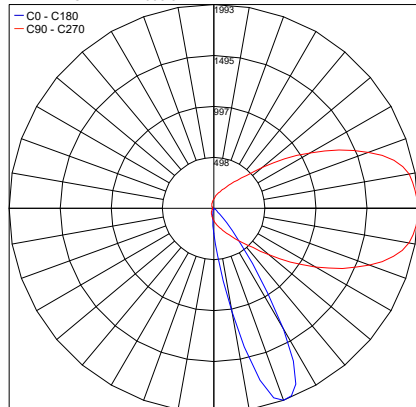

PHOTOMETRIC FILENAME : DAN M-90 - 35IN SW 30K 21° - PT6021329N.IES

Maximum Candela = 674.2

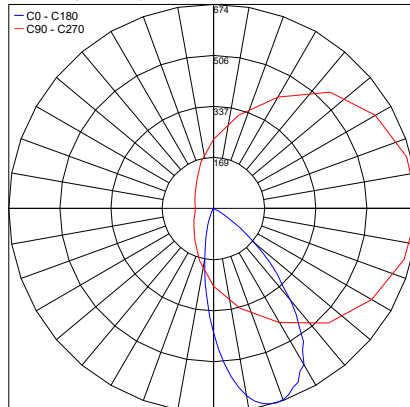

PHOTOMETRIC FILENAME : DAN M-90 - 35IN SW 30K 45° - PT6021349N.IES

Maximum Candela = 388.3

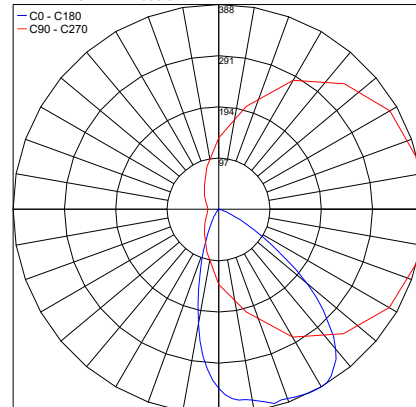

PHOTOMETRIC FILENAME : DAN M-90 - 35IN SW 30K 65° - PT6021369N.IES

Job Name/Date:

Fixture Type Designation: