

Kran is an IP66-rated bollard made of stainless steel, available in versions with 1, 2, or 3 LEDs in the head, and 2 heights for each style. It is available in 3 color temperatures, 5 optics options, and 3 Hard Coat Treatment finishes. Kran M-02 is the double LED version. Dark Sky compliant for output below 80°.

TECHNICAL DATA

Wattage	10W (M-02)
Power Supply	Integral 120VAC
Dimming	On/Off Only
Construction	Body: AISI 316L Stainless Steel Lens: Flush Black Silk-screened Glass Extra-clear, Tempered, 0.16" Thick
CCT	2700K, 3000K, 4000K
CRI	>85
Delivered Lumens	550 lm per beam (3000K) Dark Sky compliant, output below 80°
Efficacy	110 lm/W per beam (3000K)
Optics	21°, 45°, 65°, Asymmetric, Road
BUG Rating	B0-U1-G0 (21°, 45° - 3000K) B1-U1-G0 (65° - 3000K)
Lumen Maintenance	100,000 hrs L80, B10 (Ta 25°C)
Hard Coat Finishes	Inox Natural, Inox Graphite, Inox Bronze
Fixture Dimensions	23.6" or 35.4" height M-02 head: 7.24" l x 2.36" h
IP Rating	IP66
Impact Resistance	IK08
Warranty	10 Years Against Corrosion 5 Years on Electrical Components

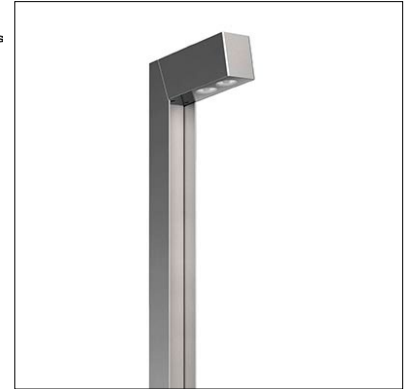

Fixture Dimensions

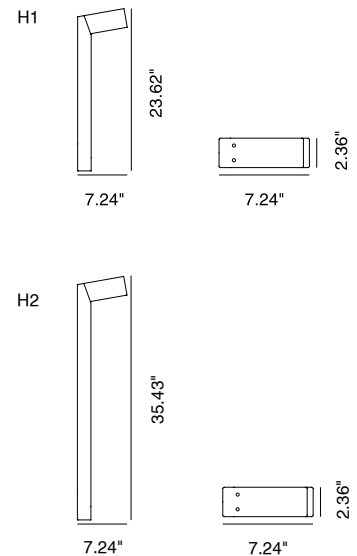

Hard Coating Treatment is the surface treatment of all the products by Stral Lighting. It is not a skin of color, but instead is a process that allows for the color to be absorbed all the way through. If a product is scratched, the color beneath is the same as the color on the surface. It guarantees a high superficial resistance to corrosion and atmospheric agents, as well as making the products anti-fingerprint and anti-stain. Available in three finishes Inox Natural, Inox Graphite and Inox Bronze.

ORDERING INFORMATION

Example: SPT6012366B.US. Accessories sold separately.

SPT6012					.US
Model No.	CCT	Optics	Height	Finishes	
SPT6012 (M-02)	2 - 2700K 3 - 3000K 4 - 4000K	2 - 21° 4 - 45° 6 - 65° 7 - Asymmetrical 8 - Road	6 - 23.6" 9 - 35.4"	N - Inox Natural G - Inox Graphite B - Inox Bronze	.US

Job Name/Date:

Fixture Type Designation:

FINISHES

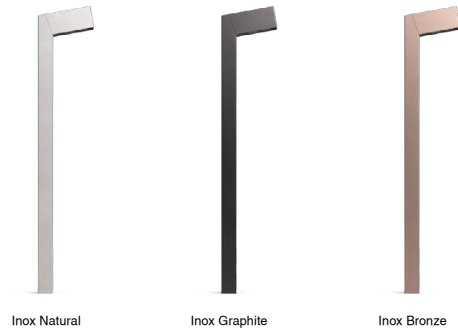

ACCESSORIES

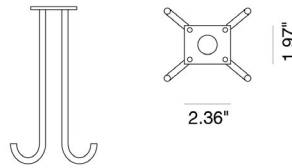

PT64000
Flange with 4 Anchor Bolts
for KRAN
(REQUIRED)

PHOTOMETRIC DATA

Note: All photometry is 3000K

21°

Maximum Candela = 3953.4

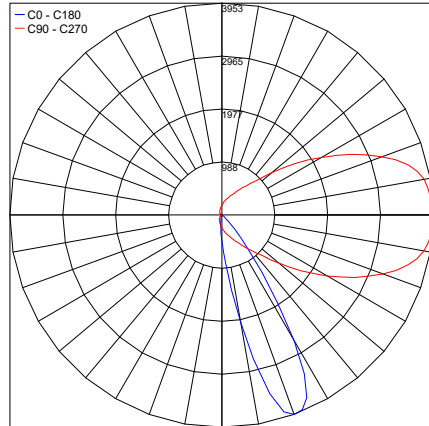

PHOTOMETRIC FILENAME : KRAN M-02 24IN 30K 21°-PT6012326N.IES

45°

Maximum Candela = 1337.0

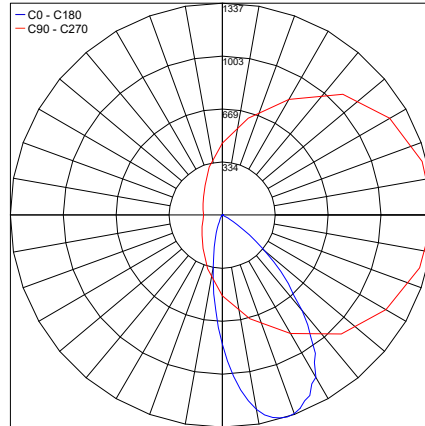

PHOTOMETRIC FILENAME : KRAN M-02 24IN 30K 45°-PT6012346N.IES

65°

Maximum Candela = 770.1

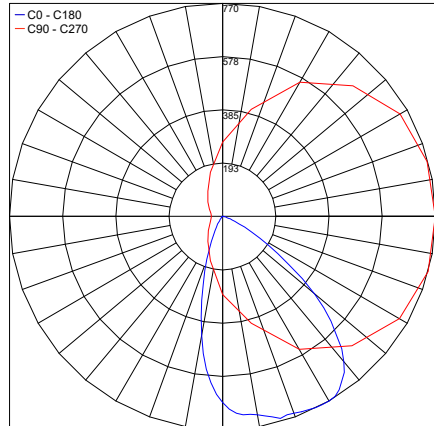

PHOTOMETRIC FILENAME : KRAN M-02 24IN 30K 65°-PT6012366N.IES

Job Name/Date:

Fixture Type Designation: