

# KRAN M-03

Kran is an IP66-rated bollard made of stainless steel, available in versions with 1, 2, or 3 LEDs in the head, and 2 heights for each style. It is available in 3 color temperatures, 5 optics options, and 3 Hard Coat Treatment finishes. Kran M-03 is the triple LED version. Dark Sky compliant for output below 80°.



## TECHNICAL DATA

<b>Wattage</b>	15W
<b>Power Supply</b>	Integral 120VAC
<b>Dimming</b>	On/Off Only
<b>Construction</b>	Body: AISI 316L Stainless Steel Lens: Flush Black Silk-screened Glass Extra-clear, Tempered, 0.16" Thick
<b>CCT</b>	2700K, 3000K, 4000K
<b>CRI</b>	>80
<b>Delivered Lumens</b>	550 lm per beam (3000K) Dark Sky compliant, output below 80°
<b>Efficacy</b>	110 lm/W per beam (3000K)
<b>Optics</b>	21°, 45°, 65°, Asymmetric, Road
<b>BUG Rating</b>	B0-U1-G0 (21° - 3000K) B1-U1-G0 (45°, 65° - 3000K)
<b>Lumen Maintenance</b>	100,000 hrs L80, B10 (Ta 25°C)
<b>Hard Coat Finishes</b>	Inox Natural, Inox Graphite, Inox Bronze
<b>Fixture Dimensions</b>	23.6" or 35.4" height M-03 head: 8.78" l x 2.36" h
<b>IP Rating</b>	IP66
<b>Impact Resistance</b>	IK08
<b>Warranty</b>	10 Years Against Corrosion 5 Years on Electrical Components

## Fixture Dimensions

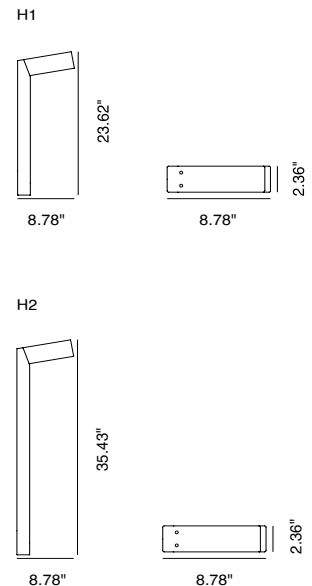

**Hard Coating Treatment** is the surface treatment of all the products by Stral Lighting. It is not a skin of color, but instead is a process that allows for the color to be absorbed all the way through. If a product is scratched, the color beneath is the same as the color on the surface. It guarantees a high superficial resistance to corrosion and atmospheric agents, as well as making the products anti-fingerprint and anti-stain. Available in three finishes Inox Natural, Inox Graphite and Inox Bronze.

## ORDERING INFORMATION

Example: SPT6013366B.US. Accessories sold separately.

SPT6013					.US
Model No.	CCT	Optics	Height	Finishes	
SPT6013 (M-03)	2 - 2700K 3 - 3000K 4 - 4000K	2 - 21° 4 - 45° 6 - 65° 7 - Asymmetrical 8 - Road	6 - 23.6" 9 - 35.4"	N - Inox Natural G - Inox Graphite B - Inox Bronze	.US

Job Name/Date:

Fixture Type Designation:

## FINISHES

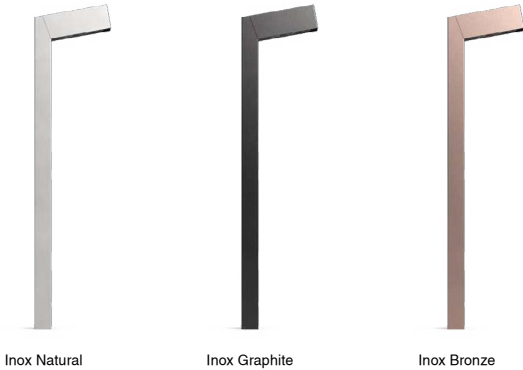

Inox Natural

Inox Graphite

Inox Bronze

## ACCESSORIES

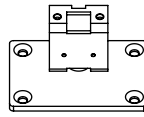

**PT64010**  
Anchor Flange  
4.13" w x 2.76" h  
**(REQUIRED)**

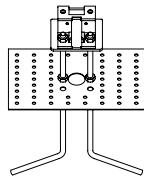
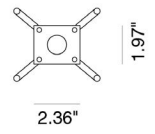
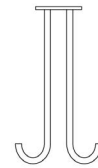

**PT64000**  
Anchor Bolts Kit  
(Set of 4 Bolts)  
6.30" w x 10.63" h x 3.94" l  
**(REQUIRED)**

## PHOTOMETRIC DATA

Note: All photometry is 3000K

21°

Maximum Candela = 5980.4

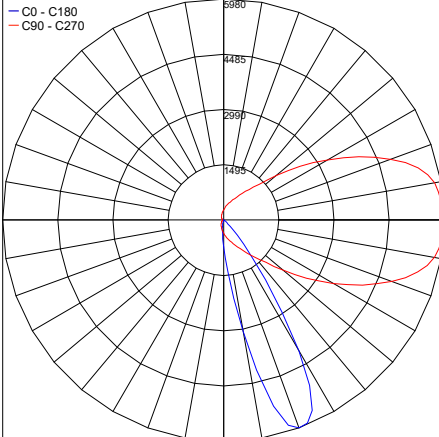

PHOTOMETRIC FILENAME : KRAN M-03 35IN 30K 21°- PT6013329N.IES

45°

Maximum Candela = 2022.6

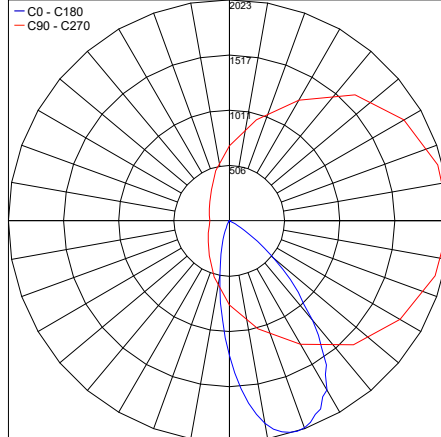

PHOTOMETRIC FILENAME : KRAN M-03 35IN 30K 45°- PT6013349N.IES

65°

Maximum Candela = 1165.0

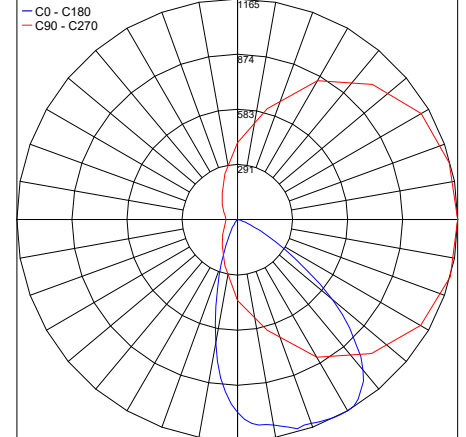

PHOTOMETRIC FILENAME : KRAN M-03 35IN 30K 65°- PT6013369N.IES

Job Name/Date:

Fixture Type Designation: