

REIKO 2.0

Reiko is a series of square outdoor projectors ideal for architectural lighting on details and facades as well as illuminating plants and trees in parks and gardens. They are available in a variety of light outputs, adjustable elliptical optics using a magnet (Reiko 3.0 and 4.0) and shadow-effect filter built into the sharp 32° optics on Reiko 3.0. Reiko 2.0 is the 2.2" square version.

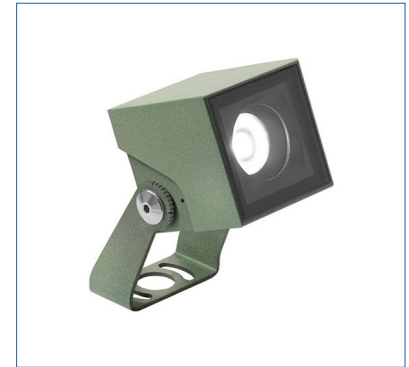

TECHNICAL DATA

Wattage / Input	3.5W (5° optics), 5W, 7W (24VDC)
Power Supply	Remote, not included. See page 2.
Construction	Body: Die-cast Aluminum Bracket: 316L Stainless Steel Lens: Serigraphed-gray and Tempered Extra-clear Glass
CCT	2700K, 3000K, 4000K
CRI	CRI 80, >90
BUG Rating	See IES files
Delivered Lumens	See Delivered Lumens Chart
Efficacy	90.4-97.6 lm/W (5W), 53.9-58.1 lm/W (7W)
Optics	12 Standard (see below)
Finishes	5 Standard, Custom RAL (see below)
Fixture Dimensions	2.17" x 2.17" x 2.36" l x 2.17" h (max 5.12" h fully extended) 0.98" wide bracket
Fixture Weight	1.10 lbs
LED Source	1 Power LED
Lumen Maintenance	L90, B10 >60,000hrs (Ta 25°C) (5° Optics) L90, B10 >50,000hrs (Ta 25°C)
Color Consistency	3-Step MacAdam (5° optics), 1/4 Ansi Bin
Operating Temp.	-4°F to +122°F
IP Rating	IP66
Impact Rating	IK06

Fixture Dimensions

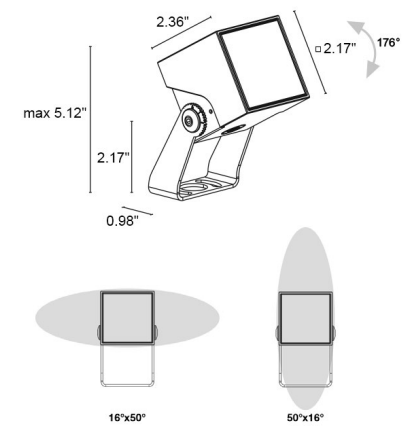

Delivered Lumens (3000K, 18°)	5W	7W
CRI 80	488 lm	407 lm
CRI >90	452 lm	377 lm

ORDERING INFORMATION

Example: RK2001100150SE or RK1001100150SE-2. Accessories / Power Supplies ordered separately.

Model #	Wattage	CRI	Optical Acces.	CCT	Optics	Finish	Cable
RK200	0 - 3.5W 1 - 5W 2 - 7W	0 - 80 1 - >90	000 - none 001 - Honeycomb <i>*Honeycomb Louver not available on 5° OR sharp optics</i>	F0 - 27K 50 - 30K 90 - 40K*	U - 5° (3.5W) L - 44° V - 8° J - 49° T - 15° K - 73° S - 18° W - 16°x50° P - 22° sharp* X - 50°x16° M - 34° Q - 56° sharp*	H - Anthracite T - Cor-ten F - Grey 5 - Jasper Green E - White C - Custom RAL <i>(consult factory for "C")</i>	4.9' standard 1 - 16.4' 2 - 32.8' 3 - 49.2' 4 - 65.6'

Job Name/Date:

Fixture Type Designation:

SUGGESTED POWER SUPPLIES

3.5W - 24VDC

Part Number	Description	Input/Output	# of Fixtures
PPLT00632	0-10V Dimming (Dim to Off)	120-277VAC to 24VDC, 12W, Class 2	1-2
PPLT00709	ELV/TRIAC & 0-10V Dimming to 5% and OFF	120-277VAC to 24VDC, 96W, Class 2, DAMP	1-21
PPLT00543	0-10V Dimming to 15% (-40°C / -40°F cold weather start)	120-277VAC to 24VDC, 100W, Class 2	2-22

Suggested Lutron Compatible - 3.5W

Part Number	Option	Lutron SKU	Dim Range	Description	Input/Output	# of Fixtures
PPLT00273	L3DAE / L3DA3W	L3DA	100%-1%	Hi-Lume™ 1% EcoSystem™ or 1% 3-Wire LED Driver	120-277VAC to 24VDC, 40W, Class 2	1-9
PPLT00530	L3DAE / L3DA3W	L3DA	100%-1%	Hi-Lume™ 1% EcoSystem™ or 1% 3-Wire LED Driver	120-277VAC to 24VDC, 96W, Class 2	1-21

SUGGESTED POWER SUPPLIES

5W - 24VDC

Part Number	Description	Input/Output	# of Fixtures
PPLT00632	0-10V Dimming (Dim to Off)	120-277VAC to 24VDC, 12W, Class 2	1-1
PPLT00709	ELV/TRIAC & 0-10V Dimming to 5% and OFF	120-277VAC to 24VDC, 96W, Class 2, DAMP	1-15
PPLT00543	0-10V Dimming to 15% (-40°C / -40°F cold weather start)	120-277VAC to 24VDC, 100W, Class 2	2-16

Suggested Lutron Compatible - 5W

Part Number	Option	Lutron SKU	Dim Range	Description	Input/Output	# of Fixtures
PPLT00273	L3DAE / L3DA3W	L3DA	100%-1%	Hi-Lume™ 1% EcoSystem™ or 1% 3-Wire LED Driver	120-277VAC to 24VDC, 40W, Class 2	1-6
PPLT00530	L3DAE / L3DA3W	L3DA	100%-1%	Hi-Lume™ 1% EcoSystem™ or 1% 3-Wire LED Driver	120-277VAC to 24VDC, 96W, Class 2	1-15

SUGGESTED POWER SUPPLIES

7W - 24VDC

Part Number	Description	Input/Output	# of Fixtures
PPLT00632	0-10V Dimming (Dim to Off)	120-277VAC to 24VDC, 12W, Class 2	1-1
PPLT00709	ELV/TRIAC & 0-10V Dimming to 5% and OFF	120-277VAC to 24VDC, 96W, Class 2, DAMP	1-10
PPLT00543	0-10V Dimming to 15% (-40°C / -40°F cold weather start)	120-277VAC to 24VDC, 100W, Class 2	1-11

Suggested Lutron Compatible - 5W

Part Number	Option	Lutron SKU	Dim Range	Description	Input/Output	# of Fixtures
PPLT00273	L3DAE / L3DA3W	L3DA	100%-1%	Hi-Lume™ 1% EcoSystem™ or 1% 3-Wire LED Driver	120-277VAC to 24VDC, 40W, Class 2	1-4
PPLT00530	L3DAE / L3DA3W	L3DA	100%-1%	Hi-Lume™ 1% EcoSystem™ or 1% 3-Wire LED Driver	120-277VAC to 24VDC, 96W, Class 2	1-10

For other power supply options consult factory.

Job Name/Date:

Fixture Type Designation:

ACCESSORIES

Installation

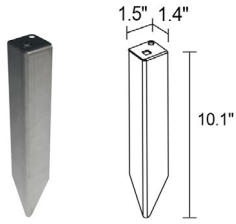

WP0100
Ground Spike
(Length 10.1")

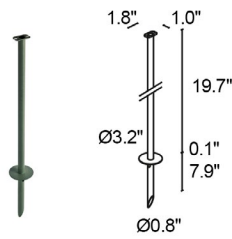

WP1006
Ground Spike (19.7" length)

WP1007
Ground Spike (31.5" length)



WP1004
Fastener Strap
(Length 16.4")



WF3302
Cable Protection Sheath
(Length 7.1")

ACCESSORIES

Anti-Glare

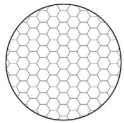

Add in the Ordering Code
Honeycomb Louvre
Not available for Sharp Optics.

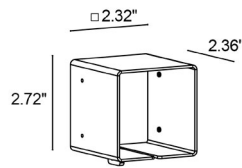

WBA10__
Standard Snout

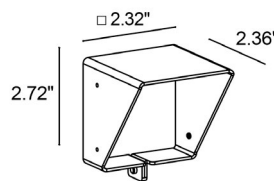

WBA11__
Asymmetric Snout

For Snouts include one of the below finishes:

- E** - White
- F** - Gray
- H** - Anthracite
- T** - Cor-ten
- 5** - Jasper Green
- C** - Custom RAL

Job Name/Date:

Fixture Type Designation:

PHOTOMETRIC DATA

Note: all Photometry is 3000K

CRI 80 - 5W

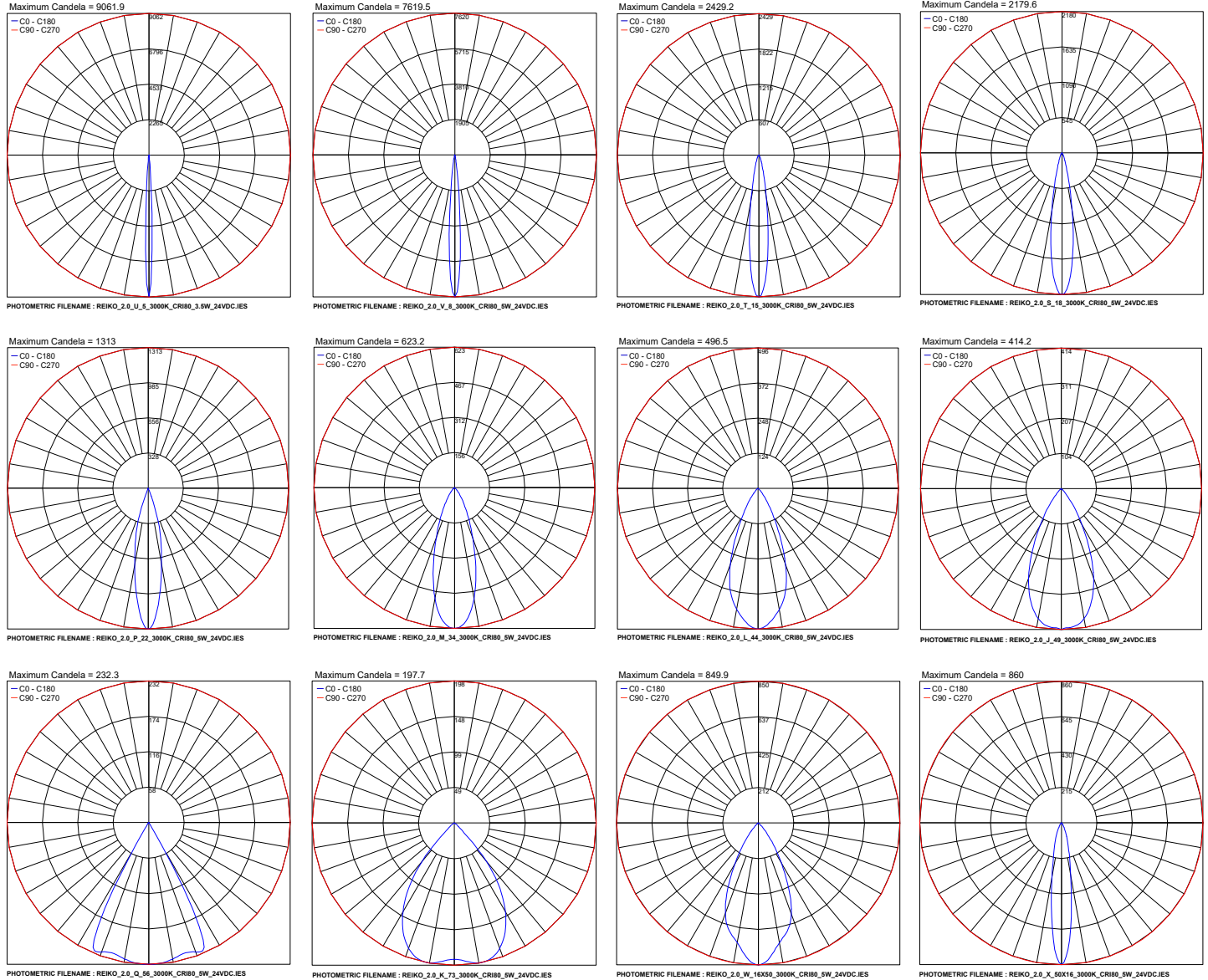

Job Name/Date:

Fixture Type Designation:

PHOTOMETRIC DATA

Note: all Photometry is 3000K

CRI 80 - 7W

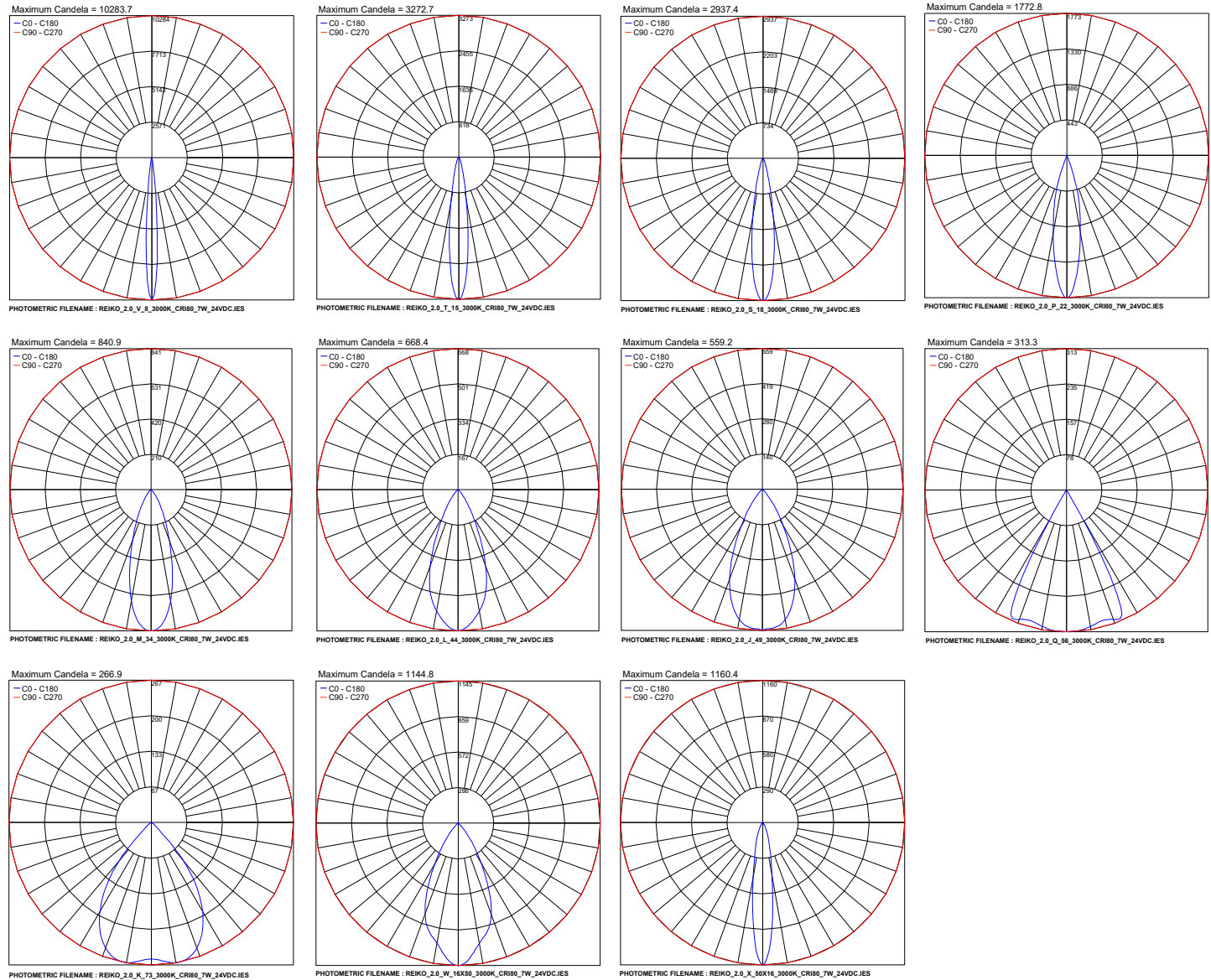

Job Name/Date:

Fixture Type Designation:

PHOTOMETRIC DATA

Note: all Photometry is 3000K

CRI 90 - 3.5W

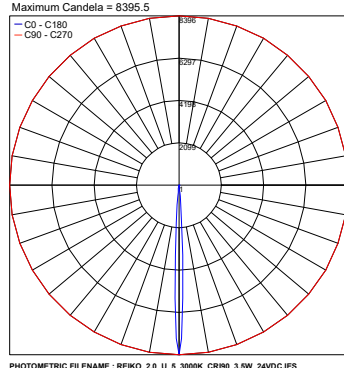

CRI 90 - 5W

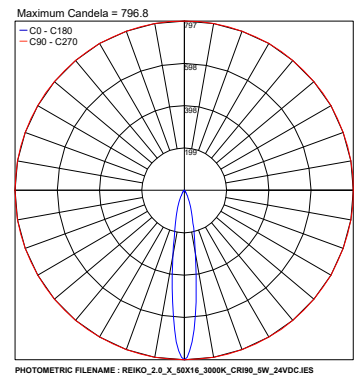
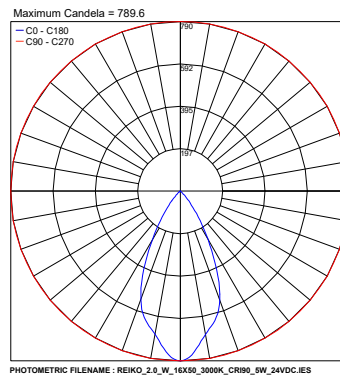
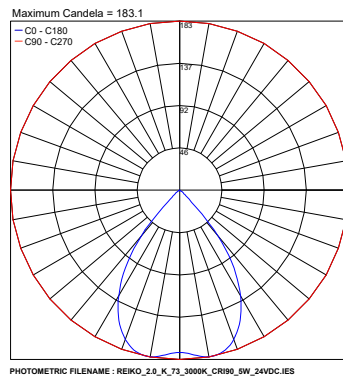
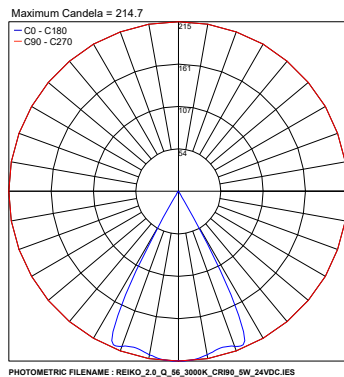
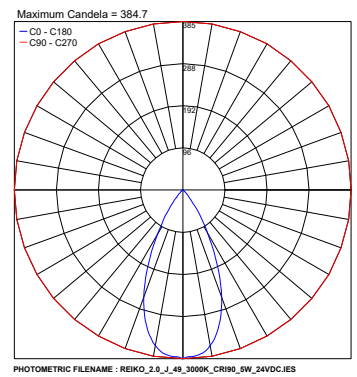
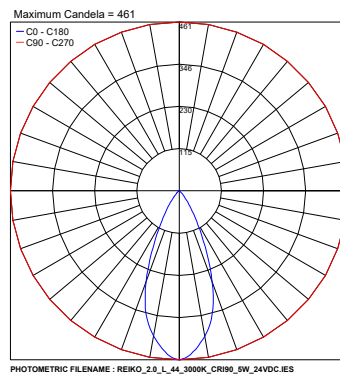
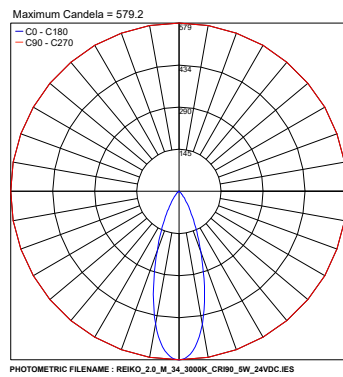
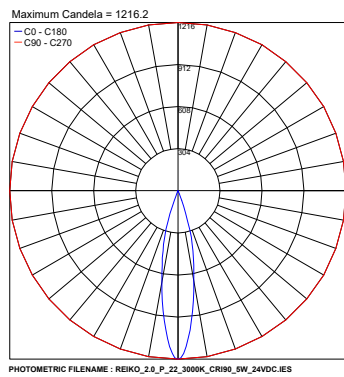
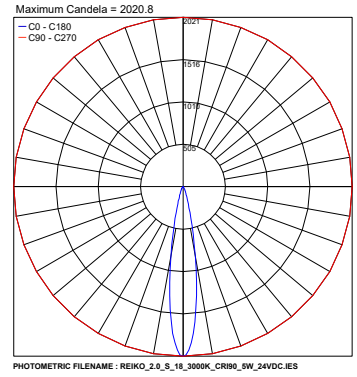
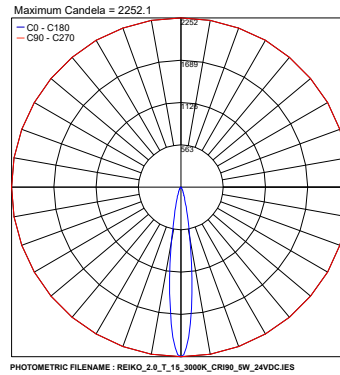
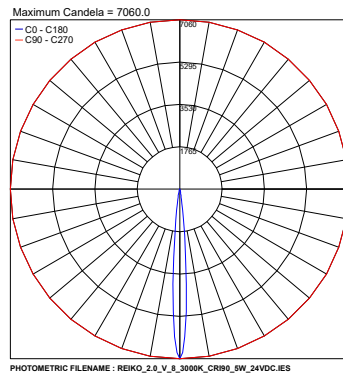

Job Name/Date:

Fixture Type Designation:

PHOTOMETRIC DATA

Note: all Photometry is 3000K

CRI 90 - 7W

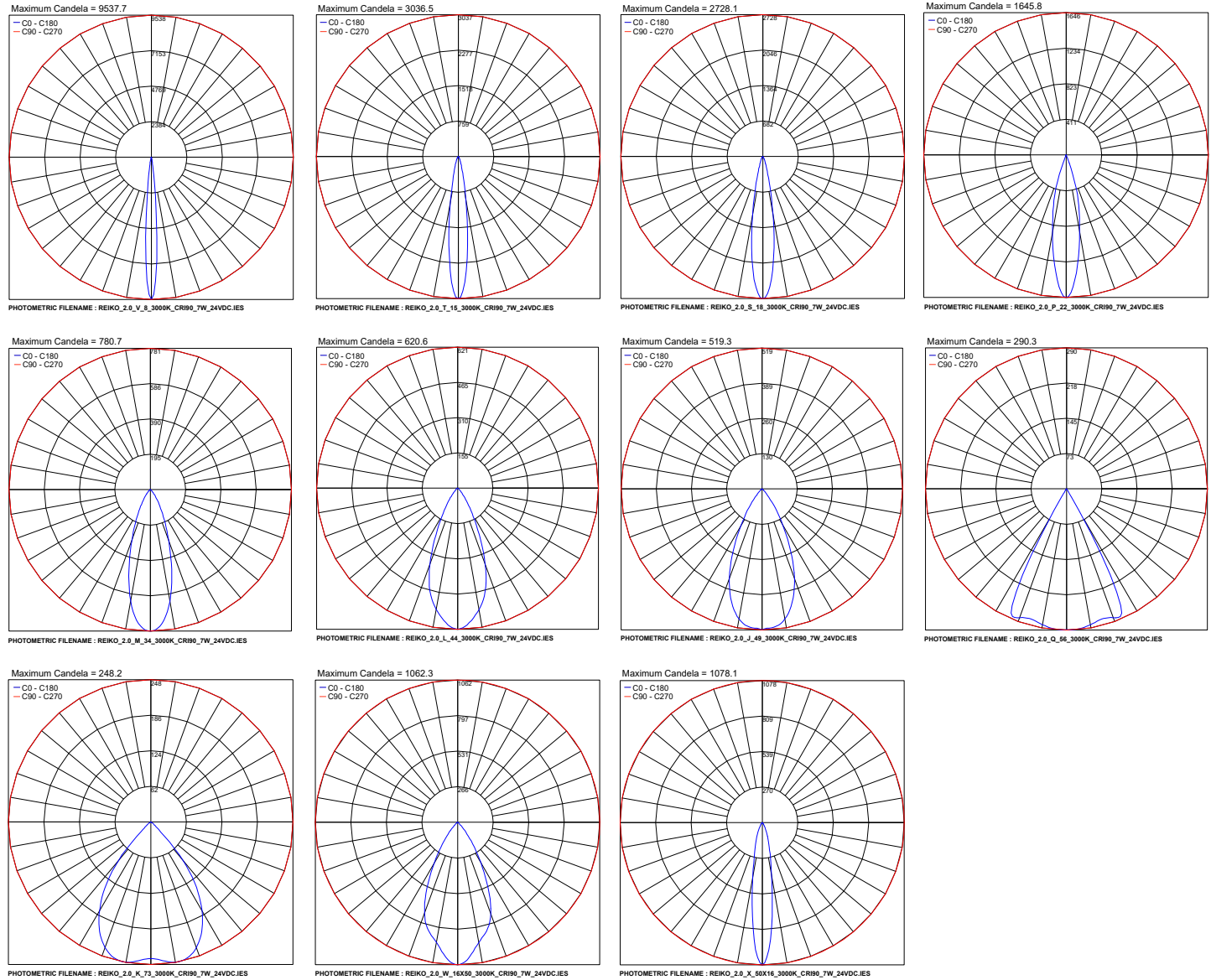

Job Name/Date:

Fixture Type Designation: