

ALTOPIANO S 1.0

Altopiano S is a family of outdoor suspended fixtures that can be coordinated with Altopiano downlights for a minimalist look for porches, canopies, hallways and corridors. They are offered in a cylindrical or square version in 2 sizes, with recessed optics, and possibility of a honeycomb louver and anti-glare shield with concentric rings, as well as a UGR of less than 19 with the narrow, medium and wide optics. Altopiano S 1.0 is the cylindrical Ø4.0" version.



TECHNICAL DATA

Wattage	8W
Power Supply	Integral 120VAC
Construction	Body: Thermally Conductive Technopolymer Trim: Stainless Steel Lens: Diffuse or Extra-clear Glass Cable Length: 9.84' standard
CCT	2200K, 2700K, 3000K, 4000K
CRI	80, >90 (2200K only available >90)
BUG Rating	B0-U0-G0 (3000K, Diffuse) B1-U0-G0 (3000K, 19°, 50°) B1-U1-G0 (3000K, 25°, 37°)
Delivered Lumens	498 lm (3000K, 25°, CRI >90) 588 lm (3000K, 25°, CRI 80)
Efficacy	62.3 lm/W (3000K, 25°, CRI >90) 73.5 lm/W (3000K, 25°, CRI 80)
Optics	5 Standard (see below)
Finishes	4 Standard, Custom RAL on request
Fixture Dimensions	Ø3.94" x 10.0" h
Fixture Weight	3.53 lbs
Lumen Maintenance	60,000 hrs L90, B10 (Ta 25°C)
Color Consistency	2-Step MacAdam
Operating Temp.	-20°C to +50°C
IP Rating	IP66
Impact Resistance	IK08

Fixture Dimensions

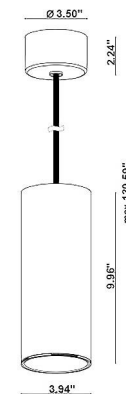

ORDERING INFORMATION

Example: AS1010100150KF. Accessories ordered separately.

AS1010						
Model #	CRI	Control System	Accessories	CCT	Optics	Finish
AS1010	0 - CRI 80 (not available on 2200K) 1 - CRI >90	0 - On / Off D - DALI-2	00 - None 01 - Honeycomb 02 - Anti-Glare <i>Honeycomb Louvre and Anti-glare Shield not available on 0D (Diffuse)</i>	N - 2200K <i>(CRI>90 only)</i> F - 2700K 5 - 3000K 9 - 4000K	0S - 19° 0M - 25° 0L - 37° 0K - 50° 0D - Diffuse	H - Anthracite T - Cor-ten F - Gray E - White C - Custom RAL <i>(consult factory for "C")</i>

Job Name/Date:

Fixture Type Designation:

ACCESSORIES

Anti-Glare

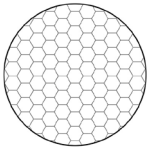

Honeycomb Louvre
Built into the fixture
Can be provided on all optics
except for diffuse

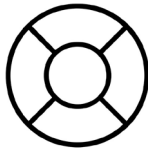

Anti-glare Shield
Built into the fixture
Can be provided on all optics
except for diffuse

Various



WNAP10A1
Windproof cable

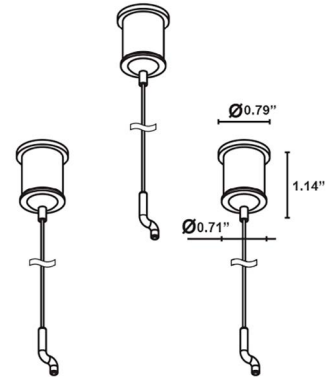

PHOTOMETRIC DATA

Note: All photometry is 3000K

CRI 80 19°

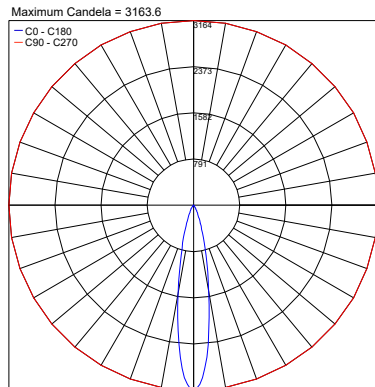

25°

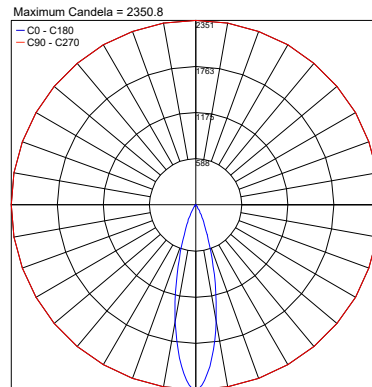

37°

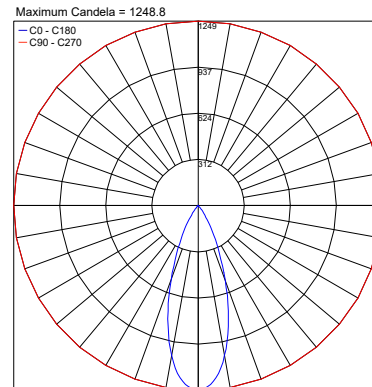

CRI 80 50°

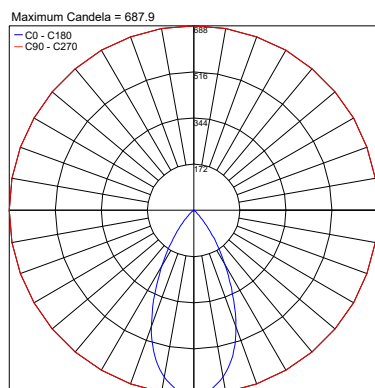

Diffuse

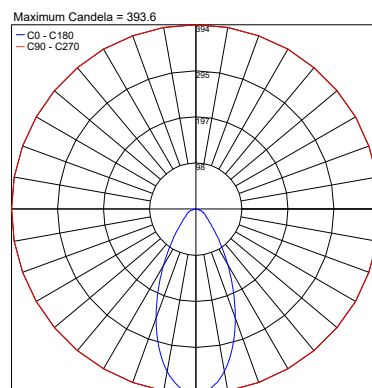

Job Name/Date:

Fixture Type Designation:

PHOTOMETRIC DATA

Note: All photometry is 3000K

CRI 90

19°

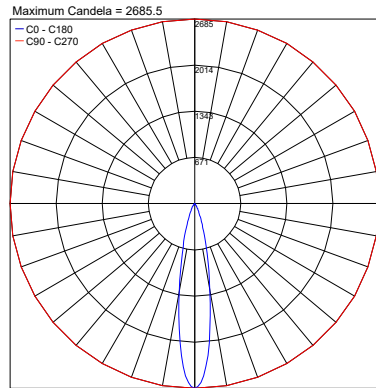

PHOTOMETRIC FILENAME : ALTOPIANO_S_1.0_S_19_3000K_CRI90_8W.IES

25°

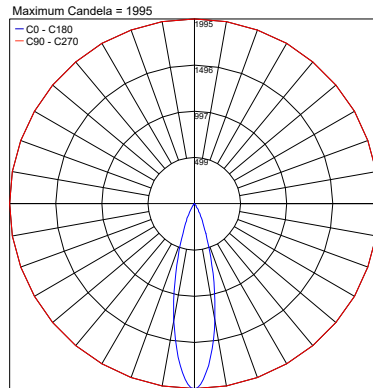

PHOTOMETRIC FILENAME : ALTOPIANO_S_1.0_M_25_3000K_CRI90_8W.IES

37°

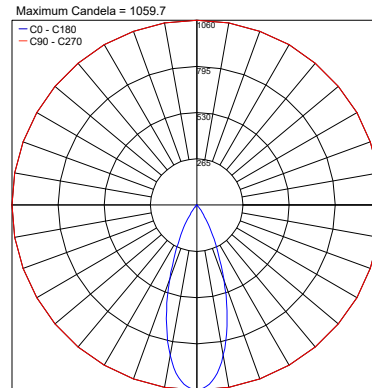

PHOTOMETRIC FILENAME : ALTOPIANO_S_1.0_L_37_3000K_CRI90_8W.IES

CRI 90

50°

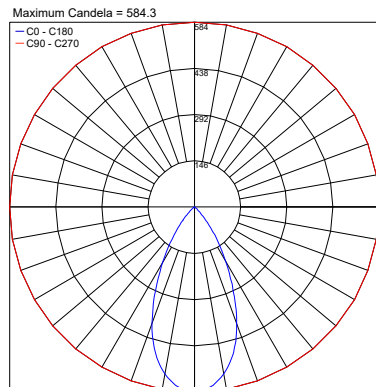

PHOTOMETRIC FILENAME : ALTOPIANO_S_1.0_K_50_3000K_CRI90_8W.IES

Diffuse

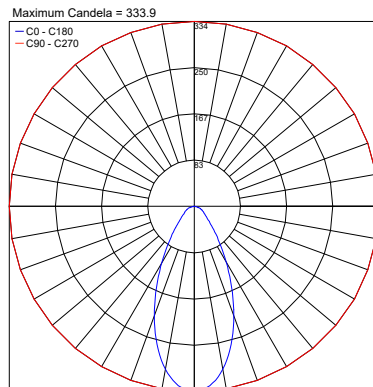

PHOTOMETRIC FILENAME : ALTOPIANO_S_1.0_D_3000K_CRI90_8W.IES

Job Name/Date:

Fixture Type Designation: