

TREVI 2.4

Trevi are a series of linear profiles suitable for outdoor and underwater applications featuring a cylindrical screen, a distinctive characteristic that enables the profile to 'disappear' in the water, leaving just its light to capture the eye. Trevi 2.4 is 47.8" in length and offers static white light with 4 optics options.



TECHNICAL DATA

| | |
|---------------------------|---|
| Wattage / Input | 41W (24VDC) |
| Power Supply | Remote, not included. See page 2. |
| Construction | End Caps: AISI 316L Stainless Steel Heat Sink: Internal Anticorodal Aluminum Lens: Transparent Polycarbonate Cable Length: 16.4 ft |
| CCT | 2200K, 2700K, 3000K, 4000K |
| CRI | 80 |
| BUG Rating | B3-U1-G0 (3000K) |
| Delivered Lumens | 3872 lm (3000K, 10°) |
| Efficacy | 94.44 lm/W (3000K, 10°) |
| Optics | 10°, 29°, 42°, 15°x47° |
| Finish | Polycarbonate |
| Fixture Dimensions | Ø1.97" x 47.76" l |
| Fixture Weight | 8.82 lbs |
| LED Source | 28 power LEDs |
| Lumen Maintenance | 60,000h L80 B10 (Ta 25°C) |
| Color Consistency | — |
| Operating Temp. | -4°F - 113°F (installation outdoors) 32°F - 113°F (installation underwater) |
| IP Rating | IP65, IP68 |
| Impact Rating | IK10 |
| Max Depth | 32.81 ft |

Fixture Dimensions

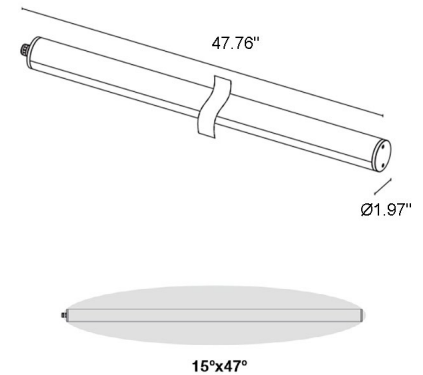

ORDERING INFORMATION

Example: TR24000000N0WP. Accessories / Power Supplies ordered separately.

| TR24000000 | | | P |
|------------|--|--|-------------------|
| Model No. | CCT | Optics | Finish |
| TR24000000 | N0 - 2200K F0 - 2700K 50 - 3000K 90 - 4000K | S - 10° M - 29° L - 42° W - 15°x47° | P - Polycarbonate |

Job Name/Date:

Fixture Type Designation:

SUGGESTED POWER SUPPLIES

STATIC WHITE - 24VDC (FOR USE WITH FOUNTAIN / WATER FEATURES)

| Part Number | Description | Input/Output | # of Fixtures |
|-------------------------------|---|--|---------------|
| FPV-100110024 | ELV / TRIAC & 0-10V Dimming (100 to 0%) | 120-277VAC to 24VDC, 96W, Class 2, NEMA 4 | 1-1 |
| FPV-100000024 | Non-Dim | 120-277VAC to 24VDC, 100W, Class 2, NEMA 4 | 1-1 |

For other power supply options consult factory.

ACCESSORIES - Installation (REQUIRED)

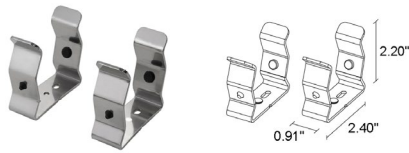

WMA04
Clips Pair

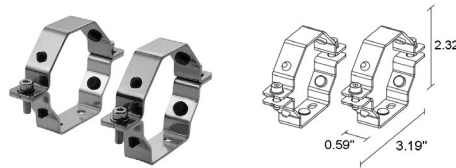

WMA05
Pair of temper-resistant clips



WMA07
Suspension Kit

Job Name/Date:

Fixture Type Designation:

PHOTOMETRIC DATA

Note all Photometry is 3000K

Maximum Candela = 85280.4

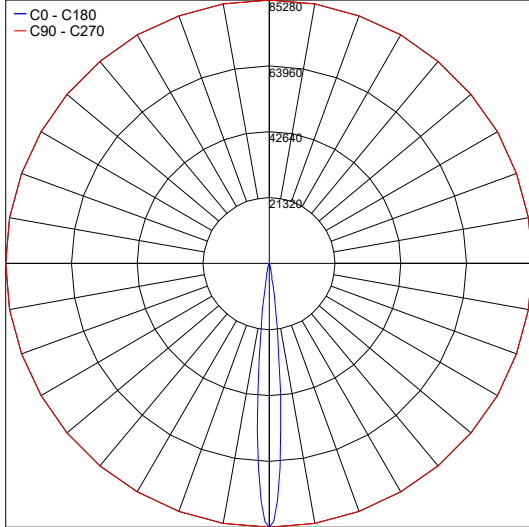

PHOTOMETRIC FILENAME : TREVI_2.4_S_10_3000K_41W_24VDC.IES

Maximum Candela = 12396.5

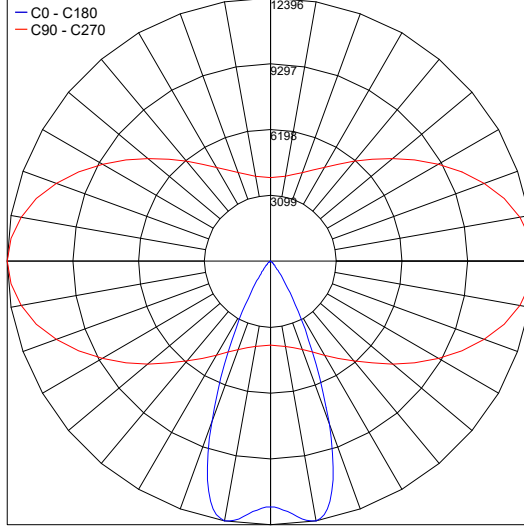

PHOTOMETRIC FILENAME : TREVI_2.4_W_15X47_3000K_41W_24VDC.IES

Maximum Candela = 14218.9

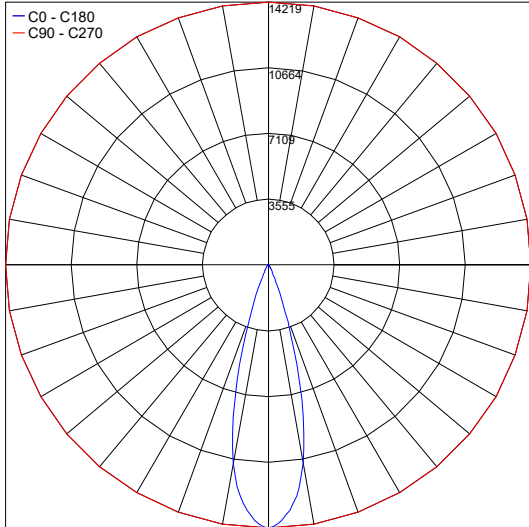

PHOTOMETRIC FILENAME : TREVI_2.4_M_29_3000K_41W_24VDC.IES

Maximum Candela = 5907.3

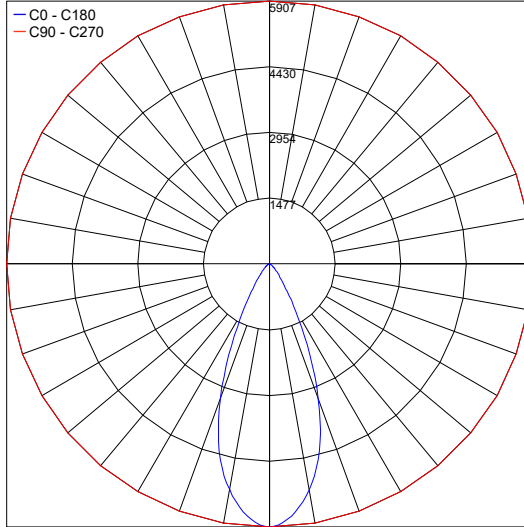

PHOTOMETRIC FILENAME : TREVI_2.4_L_42_3000K_41W_24VDC.IES

Job Name/Date:

Fixture Type Designation: