

Trevi are a series of linear profiles suitable for outdoor and underwater applications featuring a cylindrical screen, a distinctive characteristic that enables the profile to 'disappear' in the water, leaving just its light to capture the eye. Trevi 2.5 is 69.8" in length and offers static white light with 4 optics options.



TECHNICAL DATA

Wattage / Input	61W (24VDC)
Power Supply	Remote, not included. See page 2.
Construction	End Caps: AISI 316L Stainless Steel Heat Sink: Internal Anticorodal Aluminum Lens: Transparent Polycarbonate Cable Length: 16.4 ft
CCT	2200K, 2700K, 3000K, 4000K
CRI	80
BUG Rating	B3-U1-G0 (3000K, 42°, 15°x47°) B4-U1-G0 (3000K, 29°, 10°)
Delivered Lumens	5808 lm (3000K, 10°)
Efficacy	95.21 lm/W (3000K, 10°)
Optics	10°, 29°, 42°, 15°x47°
Finish	Polycarbonate
Fixture Dimensions	Ø1.97" x 69.80" l
Fixture Weight	5.84 lbs
LED Source	42 power LEDs
Lumen Maintenance	60,000h L80 B10 (Ta 25°C)
Color Consistency	—
Operating Temp.	-4°F - 113°F (installation outdoors) 32°F - 113°F (installation underwater)
IP Rating	IP65, IP68
Impact Rating	IK10
Max Depth	32.81 ft

Fixture Dimensions

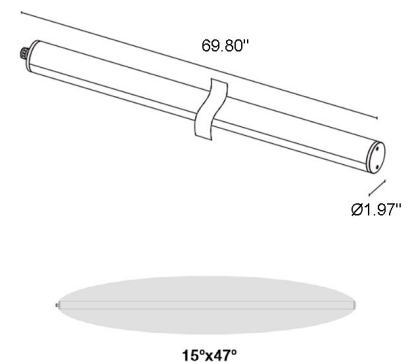

ORDERING INFORMATION

Example: TR25000000N0WP. Accessories / Power Supplies ordered separately.

TR25000000			P
Model No.	CCT	Optics	Finish
TR25000000	N0 - 2200K F0 - 2700K 50 - 3000K 90 - 4000K	S - 10° M - 29° L - 42° W - 15°x47°	P - Polycarbonate

Job Name/Date:

Fixture Type Designation:

SUGGESTED POWER SUPPLIES

STATIC WHITE - 24VDC (FOR USE WITH FOUNTAIN / WATER FEATURES)

Part Number	Description	Input/Output	# of Fixtures
FPV-100110024	ELV / TRIAC & 0-10V Dimming (100 to 0%)	120-277VAC to 24VDC, 96W, Class 2, NEMA 4	1-1
FPV-100000024	Non-Dim	120-277VAC to 24VDC, 100W, Class 2, NEMA 4	1-1

For other power supply options consult factory.

ACCESSORIES - Installation (REQUIRED)

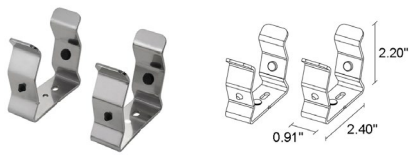

WMA04
Clips Pair

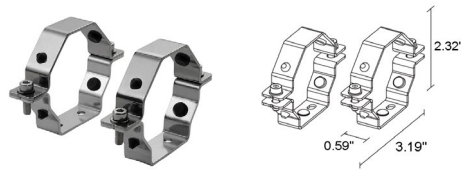

WMA05
Pair of tamper-resistant clips



WMA07
Suspension Kit

Job Name/Date:

Fixture Type Designation:

PHOTOMETRIC DATA

Note all Photometry is 3000K

Maximum Candela = 127920.6

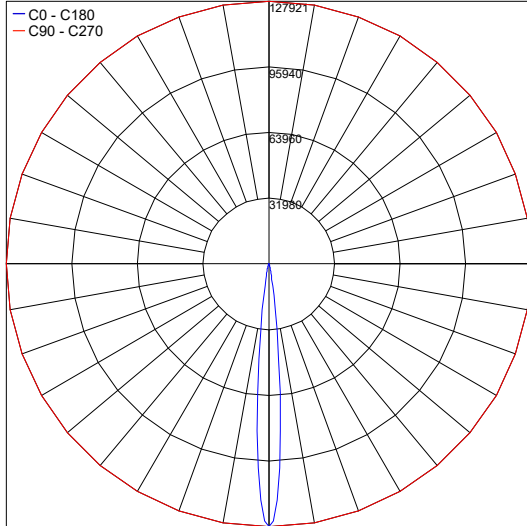

PHOTOMETRIC FILENAME : TREVI_2.5_S_10_3000K_61W_24VDC.IES

Maximum Candela = 18594.7

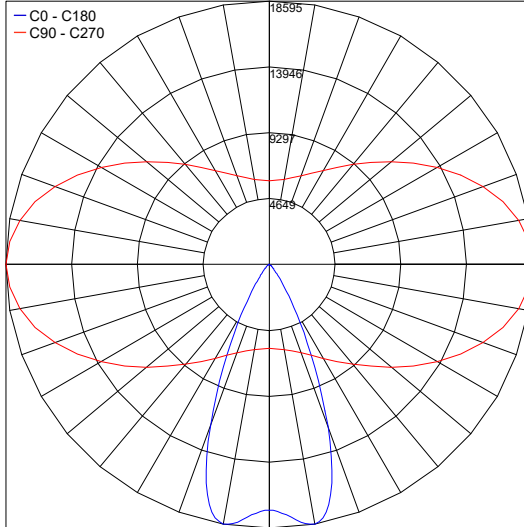

PHOTOMETRIC FILENAME : TREVI_2.5_W_15X47_3000K_61W_24VDC.IES

Maximum Candela = 21328.4

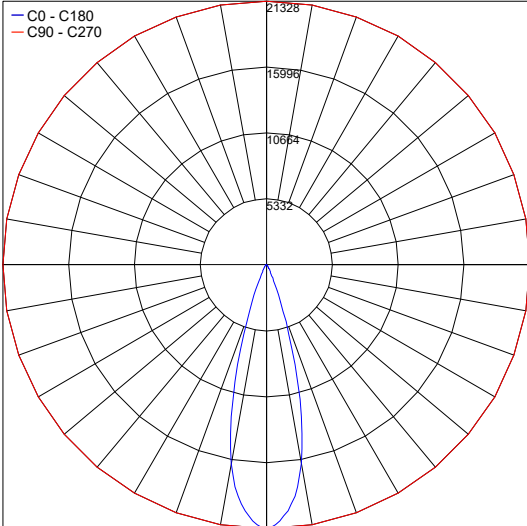

PHOTOMETRIC FILENAME : TREVI_2.5_M_29_3000K_61W_24VDC.IES

Maximum Candela = 8861

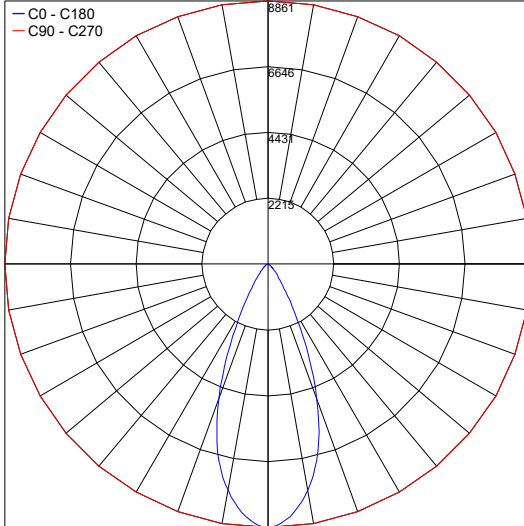

PHOTOMETRIC FILENAME : TREVI_2.5_L_42_3000K_61W_24VDC.IES

Job Name/Date:

Fixture Type Designation: