

# EASY LINE - Frost LL10

EASY LINE is a vertical, bendable LED strip that is IP65-IP68 rated ideal for fountains or swimming pools for panel installation in reinforced concrete with tiles or pool liner. It is available in Transparent, Frost, Clear or Total Light with static white, tunable white or RGB, and guarantees protection against UV rays and the corrosive action of salt and sodium hypochlorite. EASY LINE Frost has opal resin with a white outercasing. **Not cuttable in the field.**



## TECHNICAL DATA

<b>Wattage</b>	11W / 3.28 ft (1 m)	
<b>Power Supply</b>	Remote Fountain/Pool Approved 24VDC Power Supply, not included. See page 2.	
<b>Construction</b>	Body: Opal Polyurethane Resin Outercase: White PVC	
<b>CCT</b>	2850K, 3150K, 4350K, 5500K (204 LED / 3.28') Warm White on request: 2000K, 2400K, 2700K	
<b>CRI</b>	85	
<b>Delivered Lumens</b>	620 lm / 3.28' (2850K) 570 lm / 3.28' (3150K)	590 lm / 3.28' (4350K) 620 lm / 3.28' (5500K)
<b>Efficacy</b>	56.4 lm/W (2850K) 51.8 lm/W (3150K)	51.6 lm/W (4350K) 56.4 lm/W (5500K)
<b>Optics</b>	120°	
<b>Fixture Dimensions</b>	0.37" w x 0.26" h x Various Lengths	
<b>Bend Radius</b>	2.36"	
<b>LED Source</b>	SMD 3014	
<b>LED Spacing</b>	204 LED per 3.28 ft (1 m), 0.20" between LEDs	
<b>Lumen Maintenance</b>	L80, B10>50,000 hrs	
<b>Color Consistency</b>	2-3-Step MacAdam	
<b>Operating Temp.</b>	-22°F to 131°F	
<b>IP Rating</b>	IP65 / IP68	

Fixture Dimensions

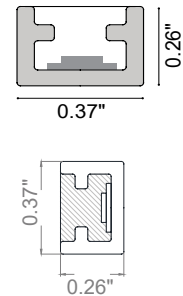

**NOT CUTTABLE IN THE FIELD**  
**MUST USE SUITABLE APPROVED FOUNTAIN & SWIMMING POOL POWER SUPPLY WHICH IS REMOTELY MOUNTED**

## ORDERING INFORMATION

Example: LL10E-N.24.68.FX.US. Power Supplies / Accessories ordered separately.

LL10E	-		24	.		.	F	.		.	US
Model No.	CCT		Power	IP Rating		Cable Exit					
LL10E - 204 LED / 3.28' (1 m)	V - 2850K	Warm White	24 - 24VDC	65 - IP65		X - End Feed					US
<div style="border: 1px solid red; padding: 5px;"> <p><b>NOTE:</b> Available in lengths up to 75 feet. Please specify length when ordering.</p> </div>	W - 3150K	On Request		68 - IP68	F - Frost	Z - Back Feed					
	N - 4350K	V8 - 2000K				<b>NOTE:</b> Back Feed (Z) only available on IP65 versions					
	C - 5500K	V2 - 2400K									
		V5 - 2700K									

Job Name/Date:

Fixture Type Designation:

## SUGGESTED POWER SUPPLIES

24VDC - **TO BE USED WITH FOUNTAIN / SWIMMING POOLS**

Part Number	Description	Input/Output	# of Fixtures
<a href="#">FPV-100110024</a>	ELV / TRIAC & 0-10V Dimming (100 to 0%)	120-277VAC to 24VDC, 100W, Class 2, IP66, NEMA 4X	1-6
<a href="#">FPV-100000024</a>	Non-Dim	120-277VAC to 24VDC, 100W, Class 2, IP66, NEMA 4X	1-7
<a href="#">FPV-100100024</a>	0-10V Dimming (2 Channels)	120-277VAC to 24VDC, 100W, Class 2, IP66, NEMA 4X	1-14

## DRIVERS IN NEMA ENCLOSURE - **FOR INDOOR/OUTDOOR USE ONLY**

Remote 24VDC - ELV / TRIAC / 0-10V



PPLT00715

Part Number	Description	Input/Output	# of Fixtures
<a href="#">PPLT00715</a>	ELV / TRIAC / 0-10V Dimming to 0.1%	120-277VAC to 24VDC, 96W, Class 2, WET/DAMP	1-6

## Suggested Lutron Compatible - **FOR INDOOR/OUTDOOR USE ONLY**

Part Number	Option	Lutron SKU	Dim Range	Description	Input/Output	# of Fixtures
<a href="#">PPLT00273</a>	L3DAE / L3DA3W	L3DA	100%-1%	Hi-Lume™ 1% EcoSystem™ or 1% 3-Wire LED Driver	120-277VAC to 24VDC, 40W, Class 2	1-2
<a href="#">PPLT00530</a>	L3DAE / L3DA3W	L3DA	100%-1%	Hi-Lume™ 1% EcoSystem™ or 1% 3-Wire LED Driver	120-277VAC to 24VDC, 96W, Class 2	1-6

For other power supply options consult factory.

## ACCESSORIES - Installation (continued on page 3)

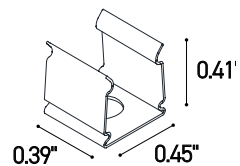

**CLIP-AC-9.5x6.5-AC**  
Harmonic steel clips

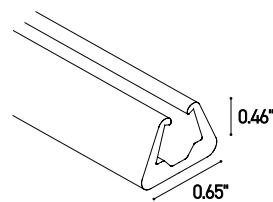
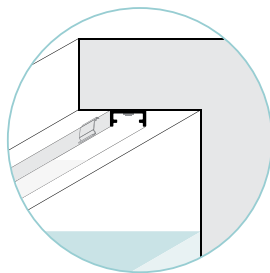

**OUT-S-9.5x6.5.F/W**  
Flexible Silicone Outercase  
L=16.4"

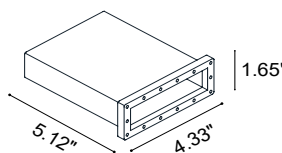
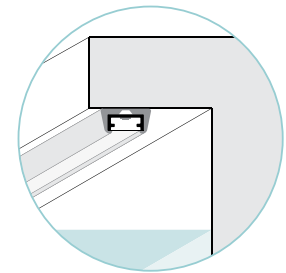

**CABLE-BOX**  
Cable box

Job Name/Date:

Fixture Type Designation:

## ACCESSORIES - Installation

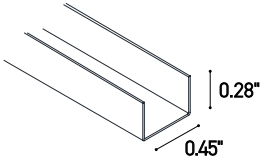

**PRO-AL-9.5x6.5-AL**  
Rigid Aluminum Outercase  
L=9.84'

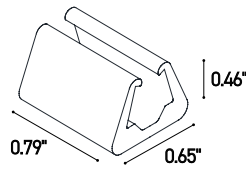
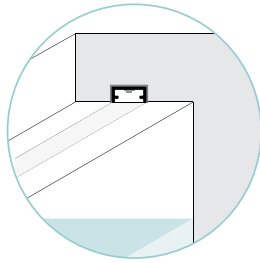

**CLIP-S-9.5x6.5.F/W**  
Silicone Clip

## POWER CABLE EXIT / AREA WITH REDUCED LIGHT

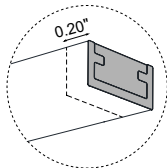

Opposite side

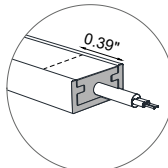

X. End feed

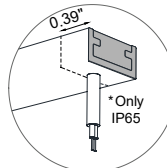

Z. Back feed  
\* Only IP65

## PHOTOMETRIC DATA

### 2850K

Maximum Candela = 162.4

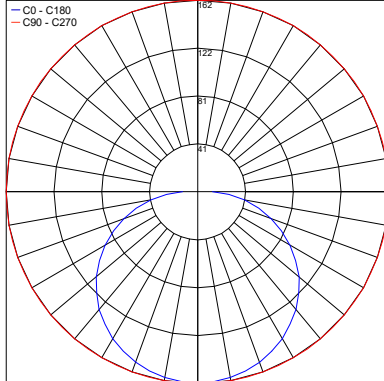

PHOTOMETRIC FILENAME : EASY LINE FROST - LL10.SVF24-6568.F 2850K.IES

### 3150K

Maximum Candela = 151.1

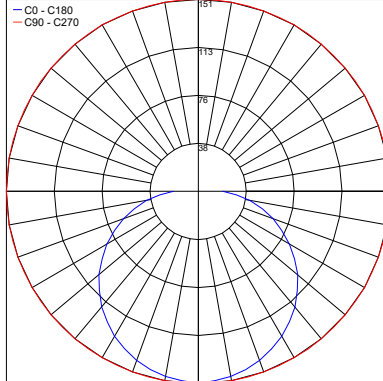

PHOTOMETRIC FILENAME : EASY LINE FROST - LL10-W.24.68.F 3150K.IES

### 4350K

Maximum Candela = 154.4

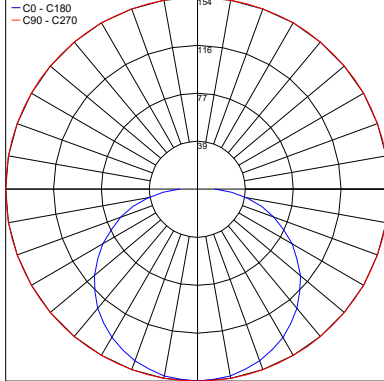

PHOTOMETRIC FILENAME : EASY LINE FROST - LL10.SNF24-6568.F 4350K.IES

### 5500K

Maximum Candela = 164

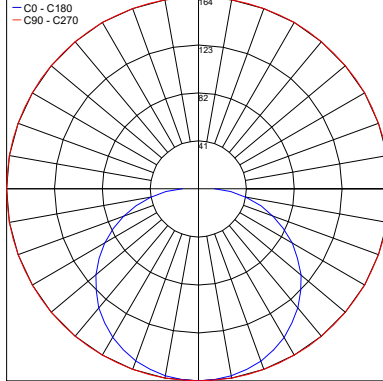

PHOTOMETRIC FILENAME : EASY LINE FROST - LL10.SCF24-6568.F 5500K.IES

Job Name/Date:

Fixture Type Designation: