

EASY LINE - Frost LL6

EASY LINE is a vertical, bendable LED strip that is IP65-IP68 rated ideal for fountains or swimming pools for panel installation in reinforced concrete with tiles or pool liner. It is available in Transparent, Frost, Clear or Total Light with static white, tunable white or RGB, and guarantees protection against UV rays and the corrosive action of salt and sodium hypochlorite. EASY LINE Frost has opal resin with a white outercasing. **Not cuttable in the field.**



TECHNICAL DATA

Wattage	8W / 3.28 ft (1 m)	
Power Supply	Remote Fountain/Pool Approved 24VDC Power Supply, not included. See page 2.	
Construction	Body: Opal Polyurethane Resin Outercase: White PVC	
CCT	2900K, 3200K, 4600K, 6400K (120 LED / 3.28') Single Colors: Red, Green, Blue, Amber Warm White on request: 2000K, 2400K, 2700K	
CRI	85	
Delivered Lumens	495 lm / 3.28' (2900K) 475 lm / 3.28' (3200K)	535 lm / 3.28' (4600K) 485 lm / 3.28' (6400K)
Efficacy	61.9 lm/W (2900K) 59.4 lm/W (3200K)	66.9 lm/W (4600K); 60.6 lm/W (6400K)
Nanoscale	Red: 625 nm Green: 525 nm	Blue: 470 nm Amber: 590 nm
Optics	120°	
Fixture Dimensions	0.55" w x 0.26" h x Various Lengths	
LED Source	SMD 3014	
LED Spacing	120 LED per 3.28 ft (1 m), 0.33" between LEDs	
Lumen Maintenance	L80,B10>50,000 hrs	
Color Consistency	2-3-Step MacAdam	
Operating Temp.	-22°F to 131°F	
IP Rating	IP65 / IP68	

Fixture Dimensions

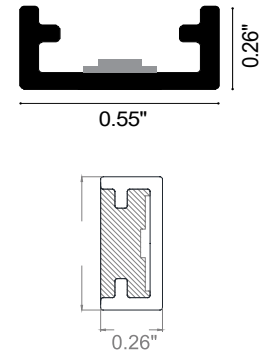

NOT CUTTABLE IN THE FIELD

ORDERING INFORMATION

Example: LL6-N.24.68.F.US. Power Supplies / Accessories ordered separately.

LL6	-		.	24	.		.	F	.	US
Model No.	CCT		Power	IP Rating						
LL6 - 120 LED / 3.28' (1 m)	V - 2900K	Warm White On Request	24 - 24VDC	65 - IP65		F				US
	W - 3200K			68 - IP68						
	N - 4600K	V8 - 2000K								
	C - 6400K	V2 - 2400K								
	R - Red	V5 - 2700K								
	G - Green									
	B - Blue									
	A - Amber									

Job Name/Date:

Fixture Type Designation:

SUGGESTED POWER SUPPLIES

24VDC - **TO BE USED WITH FOUNTAIN / SWIMMING POOLS**

Part Number	Description	Input/Output	# of Fixtures
FPV-100110024	ELV / TRIAC & 0-10V Dimming (100 to 0%)	120-277VAC to 24VDC, 100W, Class 2, NEMA 4	1-9
FPV-100000024	Non-Dim	120-277VAC to 24VDC, 100W, Class 2, NEMA 4	1-10
FPV-100100024	0-10V Dimming (2 Channels)	120-277VAC to 24VDC, 100W, Class 2, NEMA 4	1-20

SUGGESTED POWER SUPPLIES

24VDC - **TO BE USE FOR INDOOR/OUTDOOR USE - NOT** Fountain / Swimming Pool

Part Number	Description	Input/Output	# of Fixtures
PPLT00690	ELV / TRIAC & 0-10V Dimming	120-277VAC to 24VDC, 40W, Class 2, IP67	1-4
PPLT00543	0-10V Dimming to 15% (-40°C / -40°F cold weather start)	120-277VAC to 24VDC, 100W, Class 2	1-10

Suggested Lutron Compatible - **FOR INDOOR/OUTDOOR USE ONLY**

Part Number	Option	Lutron SKU	Dim Range	Description	Input/Output	# of Fixtures
PPLT00273	L3DAE / L3DA3W	L3DA	100%-1%	Hi-Lume™ 1% EcoSystem™ or 1% 3-Wire LED Driver	120-277VAC to 24VDC, 40W, Class 2	1-4
PPLT00530	L3DAE / L3DA3W	L3DA	100%-1%	Hi-Lume™ 1% EcoSystem™ or 1% 3-Wire LED Driver	120-277VAC to 24VDC, 96W, Class 2	1-9

For other power supply options consult factory.

ACCESSORIES - Installation

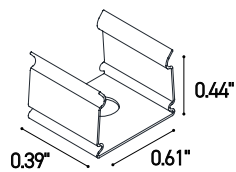

CLIP-AC-14x6.5-AC
Harmonic steel clips

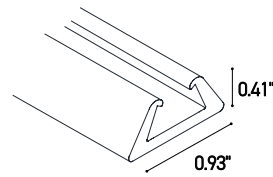
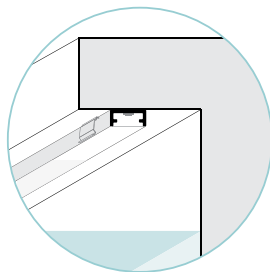

OUT-S-14x6.5.F/W
Flexible Silicone Outercase
L=16.4'

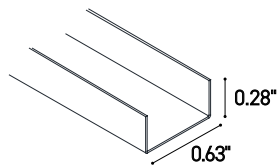
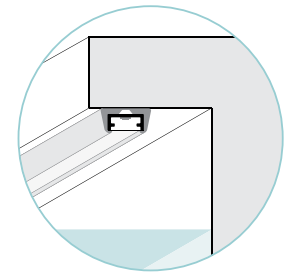

PRO-AL-14x6.5-AL
Rigid Aluminum Outercase
L=9.84'

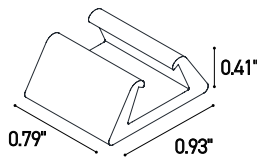
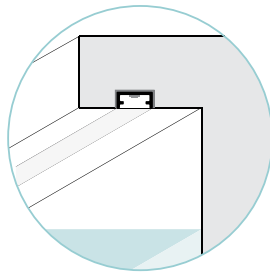

CLIP-S-14x6.5.F/W
Silicone Clip

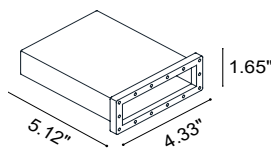

CABLE-BOX
Cable box

Job Name/Date:

Fixture Type Designation:

POWER CABLE EXIT / AREA WITH REDUCED LIGHT

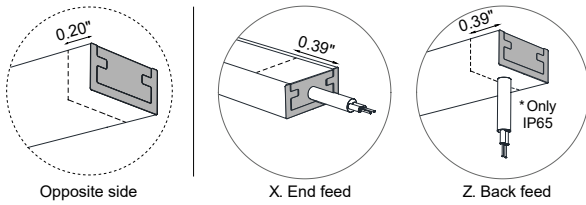

PHOTOMETRIC DATA

2900K

Maximum Candela = 66.7

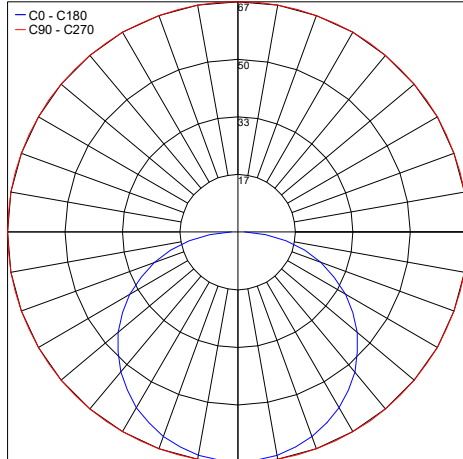

3200K

Maximum Candela = 135.1

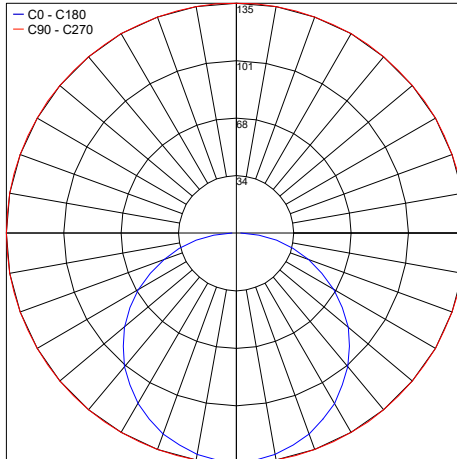

4600K

Maximum Candela = 146.3

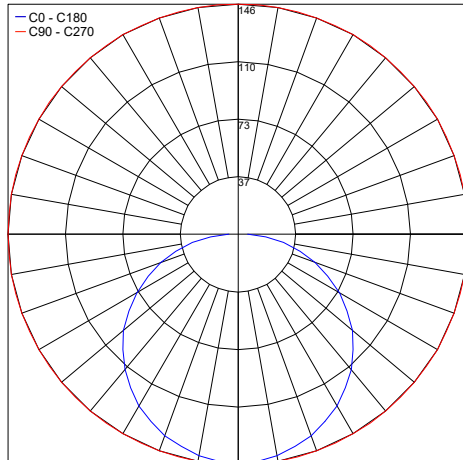

6400K

Maximum Candela = 685

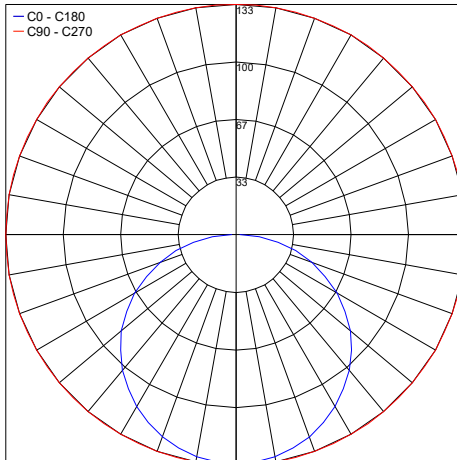

Job Name/Date:

Fixture Type Designation: