

EASY LINE - Frost LL9

EASY LINE is a vertical, bendable LED strip that is IP65-IP68 rated ideal for fountains or swimming pools for panel installation in reinforced concrete with tiles or pool liner. It is available in Transparent, Frost, Clear or Total Light with static white, tunable white or RGB, and guarantees protection against UV rays and the corrosive action of salt and sodium hypochlorite. EASY LINE Frost has opal resin with a white outercasing. **Not cuttable in the field.**



TECHNICAL DATA

Wattage	8W / 3.28 ft (1 m)	
Power Supply	Remote Fountain/Pool Approved 24VDC Power Supply, not included. See page 2.	
Construction	Body: Opal Polyurethane Resin Outercase: White PVC	
CCT	2900K, 3250K, 4800K, 5950K (204 LED / 3.28') Warm White on request: 2000K, 2400K, 2700K	
CRI	85	
Delivered Lumens	415 lm / 3.28' (2900K) 415 lm / 3.28' (3250K)	445 lm / 3.28' (4800K) 450 lm / 3.28' (5950K)
Efficacy	51.8 lm/W (2900K) 51.8 lm/W (3250K)	55.6 lm/W (4800K) 56.3 lm/W (5950K)
Optics	120°	
Fixture Dimensions	0.37" w x 0.26" h x Various Lengths	
LED Source	SMD 3014	
LED Spacing	204 LED per 3.28 ft (1 m), 0.20" between LEDs	
Lumen Maintenance	L80,B10>50,000 hrs	
Color Consistency	2-3-Step MacAdam	
Operating Temp.	-22°F to 131°F	
IP Rating	IP65 / IP68	

Fixture Dimensions

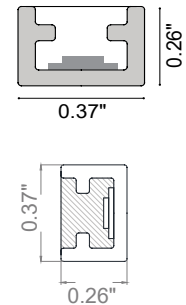

NOT CUTTABLE IN THE FIELD

ORDERING INFORMATION

Example: LL9-N.24.68.F.US. Power Supplies / Accessories ordered separately.

LL9	-		24	.		F	US
Model No.	CCT	Power	IP Rating				
LL9 - 204 LED / 3.28' (1 m)	V - 2900K W - 3250K N - 4800K C - 5950K <i>Warm White On Request</i> V8 - 2000K V2 - 2400K V5 - 2700K	24 - 24VDC	65 - IP65 68 - IP68			F - Frost	US

Job Name/Date:

Fixture Type Designation:

SUGGESTED POWER SUPPLIES

24VDC

Part Number	Description	Input/Output	# of Fixtures
PPLT00056	Non-Dim	120-277VAC to 24VDC, 26W, Class 2, IP66	1-2
PPLT00690	ELV / TRIAC & 0-10V Dimming	120-277VAC to 24VDC, 40W, Class 2, IP67	1-4
PPLT00284	Non-Dim	120-277VAC to 24VDC, 100W, Class 2, DAMP	1-10
PPLT00543	0-10V Dimming to 15% (-40°C / -40°F cold weather start)	120-277VAC to 24VDC, 100W, Class 2	1-10

Suggested Lutron Compatible

Part Number	Option	Lutron SKU	Dim Range	Description	Input/Output	# of Fixtures
PPLT00273	L3DAE / L3DA3W	L3DA	100%-1%	Hi-Lume™ 1% EcoSystem™ or 1% 3-Wire LED Driver	120-277VAC to 24VDC, 40W, Class 2	1-4
PPLT00530	L3DAE / L3DA3W	L3DA	100%-1%	Hi-Lume™ 1% EcoSystem™ or 1% 3-Wire LED Driver	120-277VAC to 24VDC, 96W, Class 2	1-9

For other power supply options consult factory.

ACCESSORIES - Installation

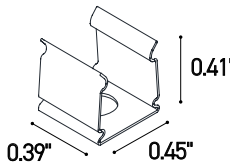

CLIP-AC-9.5x6.5-AC
Harmonic steel clips

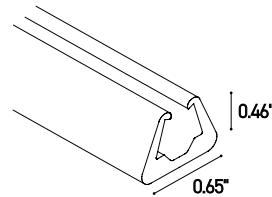
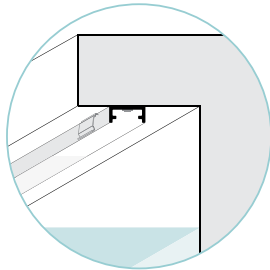

OUT-S-9.5x6.5.F/W
Flexible Silicone Outercase
L=16.4"

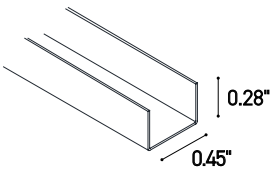
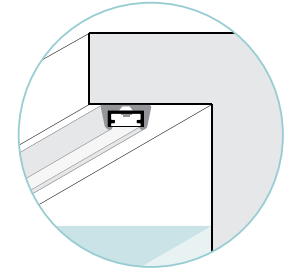

PRO-AL-9.5x6.5-AL
Rigid Aluminum Outercase
L=9.84'

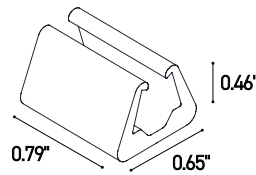
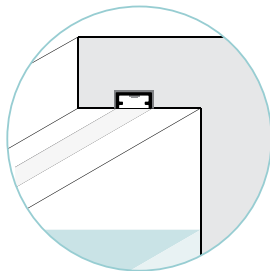

CLIP-S-9.5x6.5.F/W
Silicone Clip

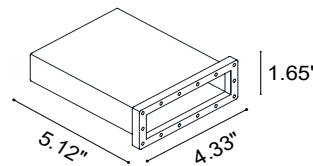

CABLE-BOX
Cable box

Job Name/Date:

Fixture Type Designation:

POWER CABLE EXIT / AREA WITH REDUCED LIGHT

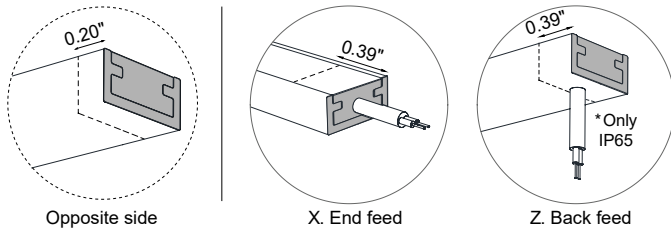

CONNECTORS



THB.381.A2A.R
Micro plug and socket connector.
2PIN. male+female.
IP68. Ø0.55" x 3.54".
Compatible for all models except RGB, RGBW and Tunable white.



THB.387.A4A.L.R
Micro plug and socket connector.
4PIN. male+female.
IP68. Ø0.91" x 4.45".
Compatible for all models except RGBW.



THB.391.A4A.L.R
Mini In-line circular joint connector.
4PIN. male+female.
IP68. Ø0.91" x 3.74".
Compatible for all models except RGBW.



THB.402.D4A.R
Connector type "T". 4PIN.
IP68. Ø1.26" x 3.58" x 4.76".
Compatible for all models except RGBW.



THB.209.A4A
Junction box type "H". 4PIN.
IP68. 4.25" x 2.56" x 1.10".
Compatible for all models except RGBW.



THB.399.D4E
Connector type "Y". 4PIN.
IP68. Ø1.26" x 2.48" x 7.09".
Compatible for all models except RGBW.



THB.392.A4A
Connector type "H". 4PIN.
IP68. Ø1.10" x 2.13" x 3.15".
Compatible for all models except RGBW.



THB.390.C1A
Connector type "T". 3PIN.
IP68. Ø1.26" x 3.62" x 2.87".
Compatible for all models except RGB and RGBW.

Job Name/Date:

Fixture Type Designation:

PHOTOMETRIC DATA

2900K

Maximum Candela = 42.2

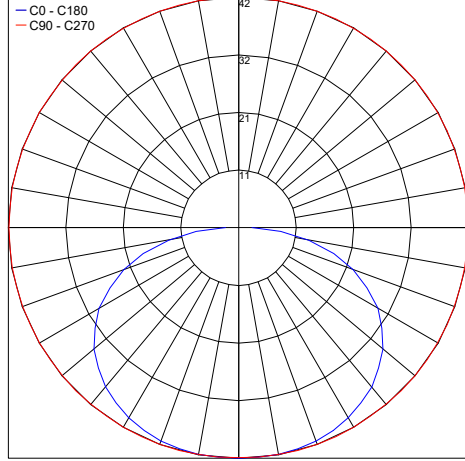

PHOTOMETRIC FILENAME : EASY LINE FROST - LL9.SVF24(R).F 2900K.IES

3250K

Maximum Candela = 114.2

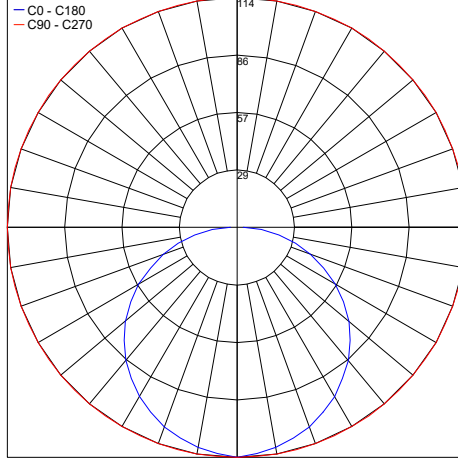

PHOTOMETRIC FILENAME : EASY LINE FROST - LL9.SWF24-6568.F 3250K.IES

4800K

Maximum Candela = 120.6

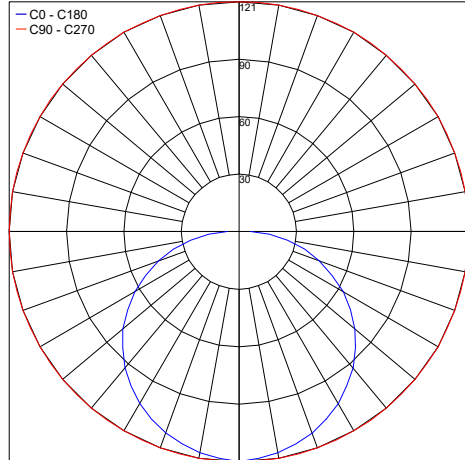

PHOTOMETRIC FILENAME : EASY LINE FROST - LL9.SNF24-6568.F 4800K.IES

5950K

Maximum Candela = 123.8

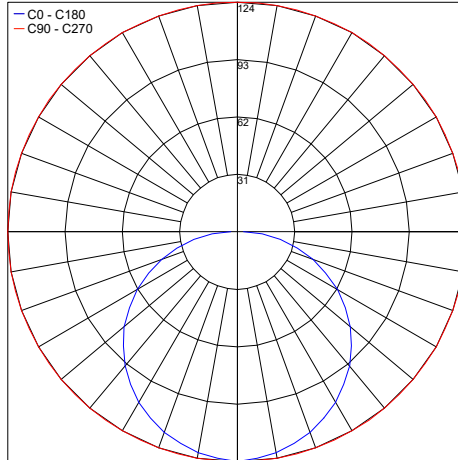

PHOTOMETRIC FILENAME : EASY LINE FROST - LL9.SCF24-6568.F 5950K.IES

Job Name/Date:

Fixture Type Designation: