



INSTRUCTIONS PERTAINING TO RISK OF FIRE OR INJURY TO PERSONS. READ ALL INSTRUCTIONS. IMPORTANT SAFETY INSTRUCTIONS. SAVE THESE INSTRUCTIONS.

DANGER - RISK OF SHOCK - DISCONNECT POWER BEFORE INSTALLATION! Please read all instructions before installation.

- Keep these instructions for future reference.
- Must be installed by a qualified electrician in accordance with national and local standards. Designplan is not responsible for fixtures installed without regard to these standards.
- Unauthorized alterations or tampering of product voids warranty.
- The main power connection must be in accordance with local electrical codes.
- Suitable for OUTDOOR or INDOOR applications.



IP65/IP68

Electrical Connections:

- LED lights must be **connected in parallel** respecting polarities.
- **CHOOSE POWER SUPPLY ACCORDINGLY.** Please consider the voltage through which fixtures are fed as well as the max power consumption.
- **Connect power only if all the fixtures are connected.**
- This unit must be used in conjunction with a suitable fountain rated power supply.
- Use only Class 2 type electronic power supply.
- Never use switches on secondary circuit.

Maintenance

Scheduled maintenance must be carried out once a year on all lighting devices, regardless of appliance class and type of use. It must include the following operations:

- Periodically clean fixtures to remove dirt from gratings and screw heads.
- Check tightness of screws on various parts of the device.
- Check that all cable glands and cables are intact and tight. Check that the glass or plastic lens is intact, and replace it if broken or damaged.
- The internal components such as the ballast, driver, washers and screws must not show clear signs of oxidation or rust. Clear traces of rust and oxidation will indicate the presence of water inside the device.
- In the case of damage, the components must be replaced by original components or spare parts.

GENERAL INFORMATION

The safety of the luminaire is only ensured if the following instructions are followed properly. Keep these instructions for future maintenance.

SAFETY INSTRUCTIONS

- It is absolutely necessary to isolate the mains supply before beginning any installation, inspection, maintenance or cleaning;
- Installation and maintenance must be carried out only by trained specialist personnel with appropriate professional qualifications in accordance with the latest electrical installation and safety regulations;
- Installation and operating of this luminaire are subject to international safety regulations. The manufacturer is not liable for damage caused by improper use. Any unapproved modification could void the manufacturer's warranty;
- Every kind of modification or manumission of products that has to be installed and used as supplied and in compliance with current regulations is forbidden;
- If malfunctions occur, please directly contact LED ITALY Srl;
- After removing the packaging, check the integrity of the product;
- Not fed to a voltage higher than that shown on the product;
- The maximum admissible ambient temperature of the luminaire may not be exceeded. Surpassing that temperature reduces the service life and, in extreme cases, poses risk of early failure;
- To protect the sensitive surfaces from dirt and fingerprints it is recommended to wear protective gloves during the assembly;
- The appliance is only suitable for installation on non-combustible surfaces;
- The transport and storage of the luminaire must be in the original packaging.

MOUNTING INSTRUCTION

- Best temperature for assembly is between +18 °C and +45 °C (+64.4 °F and +113 °F);
- Best temperature for storage is between -30° C and +85 ° C (-22 °F and +185 °F);
- The installation surface must be dry and clean;
- Surface must be free of dust, grease, oil or separating agents;
- For cleaning use clean cloth and material-compliant detergents like Isopropanol.

Attention: THE PRODUCT'S WARRANTY IS VALID ONLY IF THE INSTRUCTIONS HAVE BEEN OBSERVED.

To avoid

NO DON'T PRESS



NO DON'T TWIST



NO DON'T STEP ON



NO DON'T PULL



NO DON'T CUT



01

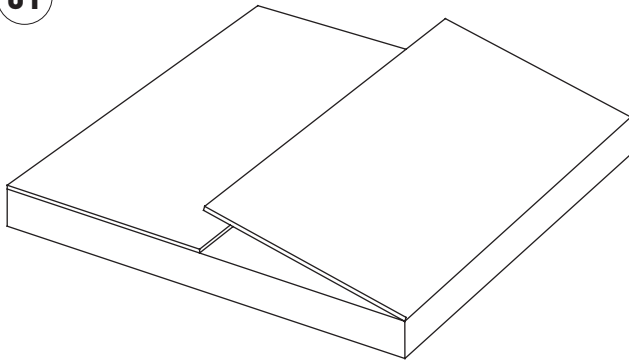

OPEN THE PACKAGE CAREFULLY

Make sure not to damage the encapsulation of the product when opening the package with a sharp object (Cutter knife / Scissors), otherwise, no adequate protection of the LED strip is guaranteed. After receiving the package, please check the integrity and completeness of product.

02

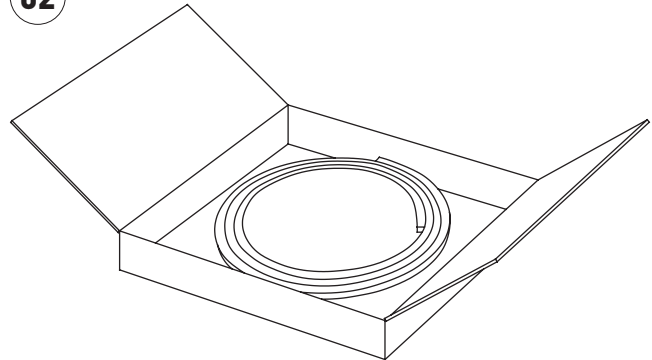

TEMPERATURE FOR ASSEMBLY

To ensure proper installation, they must be brought to room temperature before installation. Depending on the storage location (-30°C / +85°C), the flexibility of the luminaire can be significantly reduced when temperatures are too low. Warming up to room temperature makes the luminaire flexible for proper assembly. In the case of temperatures below +18 °C, keep the product switched on for at least **30 minutes in the place of installation**, before unrolling it.

The best temperature for assembly is between +18°C to +35°C.

03

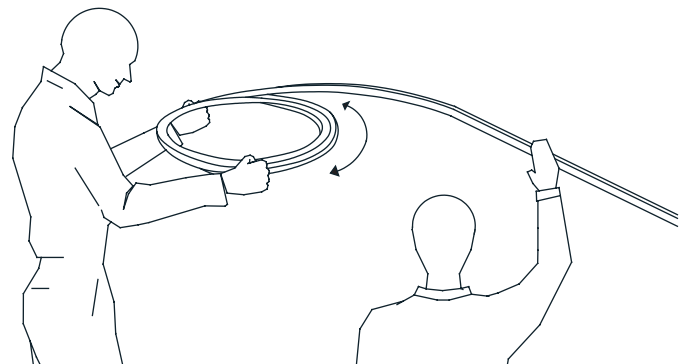
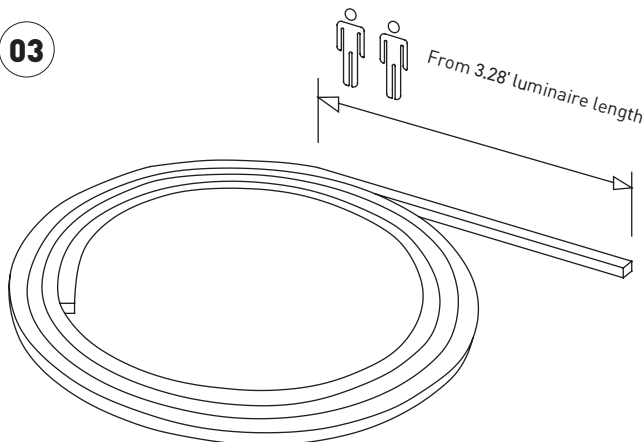

UNROLL THE PRODUCT

Unroll the product gradually and carefully from the packing.

Attention: If the luminaire is longer than 3.28', the installation should be done by two people: one person for pressing the product onto the surface and one person to hold up the package with the rest of the luminaire. During the installation of the product, especially when the product is longer than 6.56', it is important to handle it very careful. Otherwise the conductor tracks in the product can easily be damaged through improper bending.

It is important to make sure that no part of the product is hanging down.

Thereby, the bending radius can be undershot and the product can take extensive damage.

TOP EMISSION

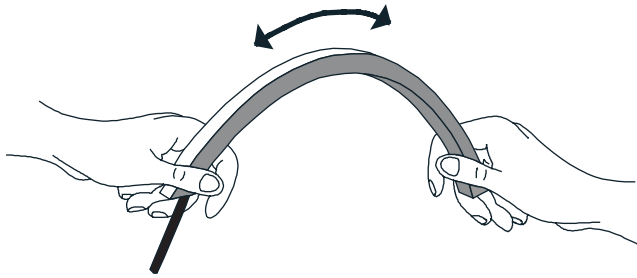

VERTICAL BENDABLE

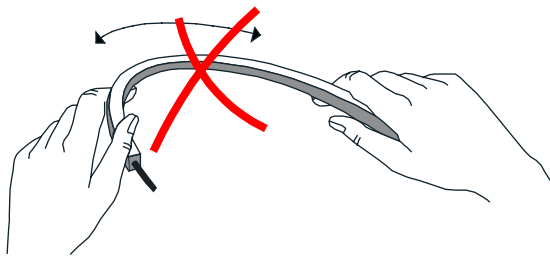
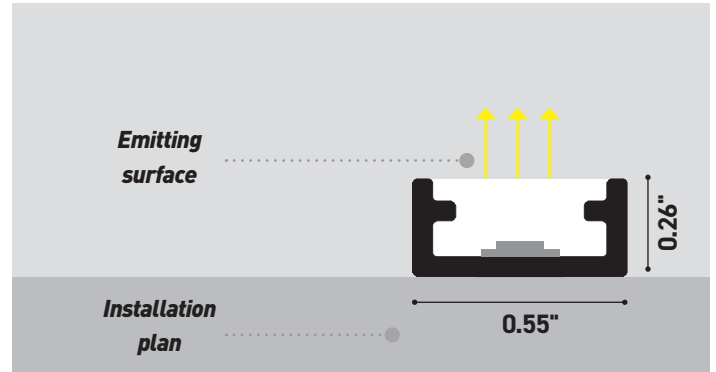

NO

NO FLEX IN THE OPPOSITE DIRECTION

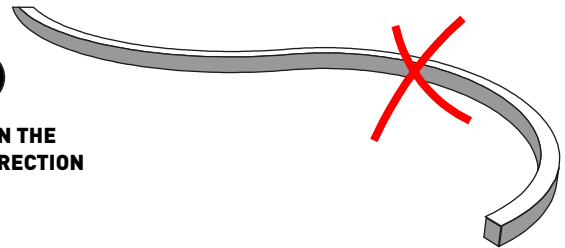

Note. The strip is vertical bendable. Curve the profile only in the indicated axis. In case of non-observance of the given indication, the electrical functionality of the product will be compromised, with consequent luminous interruption of the LED strip. Do not twist it.

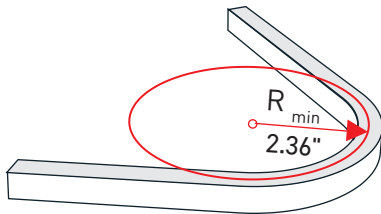

MINIMUM CURVATURE RADIUS

Note. Do not bend the profile with radius less than 2.36". In case of curvature less than the indicated value, the electrical functionality of the product will be compromised, with consequent luminous interruption of the LED strip.

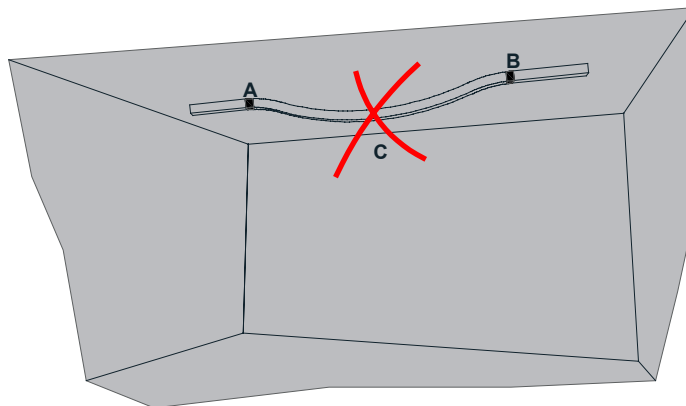

Note. In the case of a ceiling installation, respect a distance between the two A and B fastening clips of 19.69" to prevent the product from having unwanted bending at the intermediate point C.

Mounting scheme with harmonic steel clips



Countersunk screw
to fix the product
to the installation plane

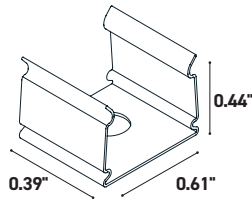

CLIP-AC-14x6.5-AC
Harmonic steel clips
to press-in the LED strip

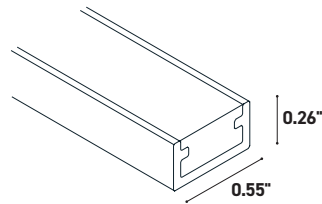

LED strip
extruded in flexible PVC and treated
with polyurethane resin

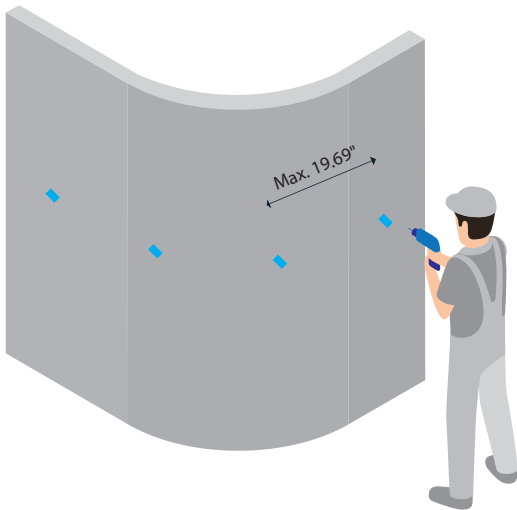
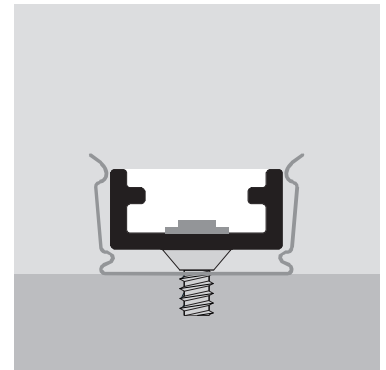

01. Prepare the screw inlet by drilling the installation plan.

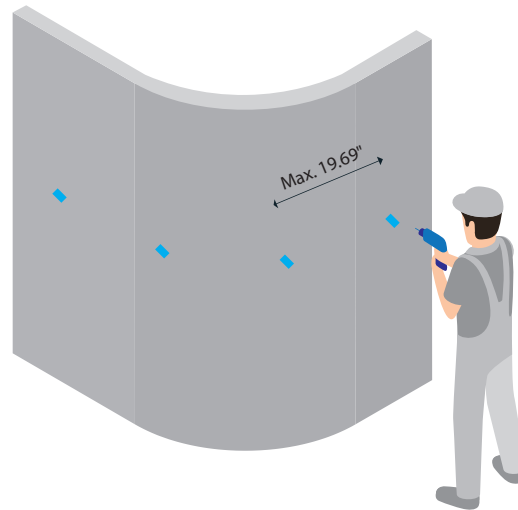

02. By placing the clip on the installation plane, fasten it to the same with the countersunk screw.

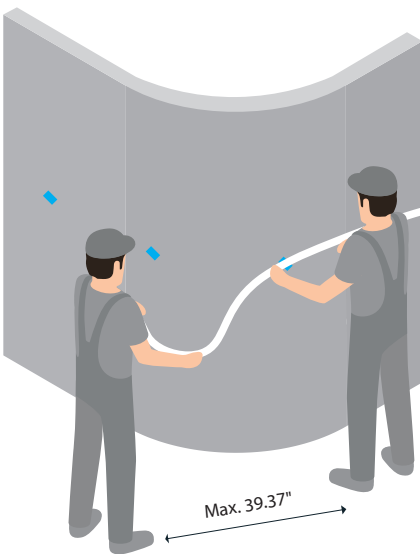

03. Enter the LED strip in the clip by pressing.

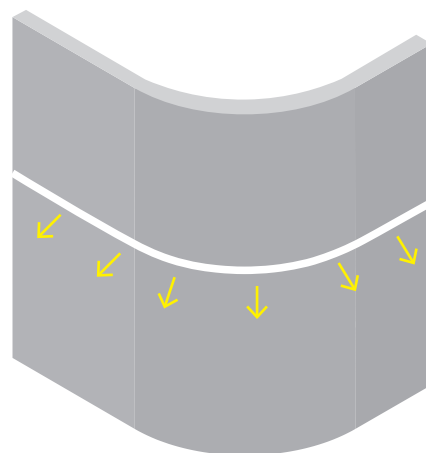

04. Connect.

Mounting scheme with **silicone clips**



Countersunk screw
to fix the product
to the installation plane

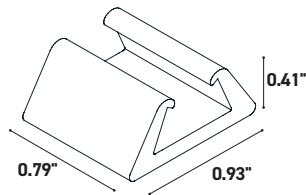

CLIP-S-14x6.5.F/W
Silicone clips
to press-in the LED strip

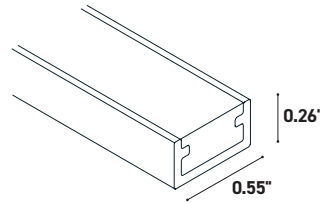

LED strip
extruded in flexible PVC and treated
with polyurethane resin

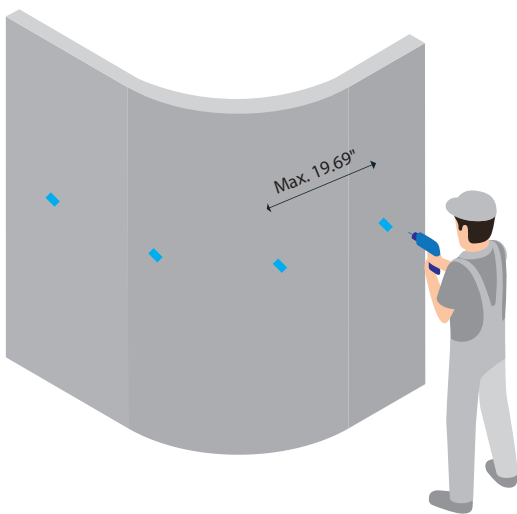
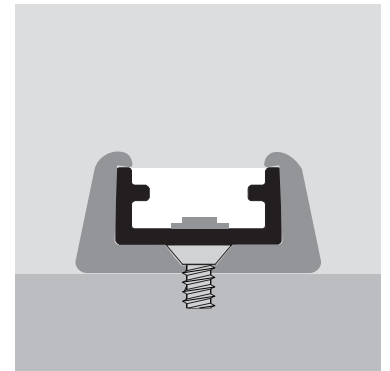

01. Prepare the screw inlet by drilling the installation plan.

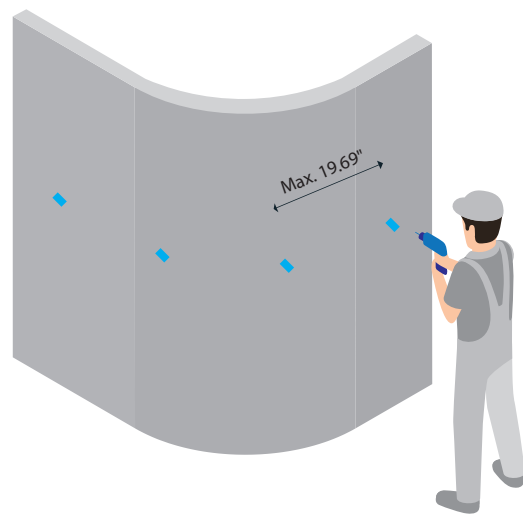

02. By placing the clip on the installation plane, fasten it to the same with the countersunk screw.

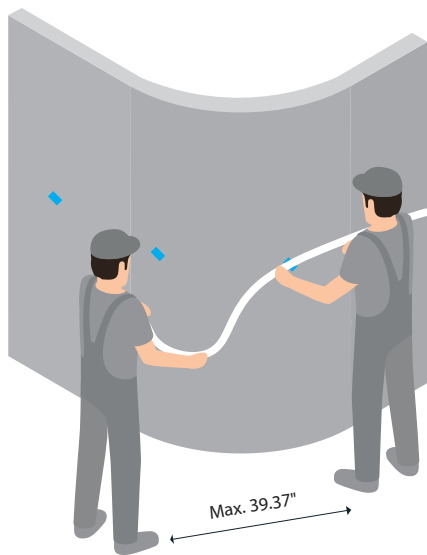

03. Enter the LED strip in the clip by pressing.

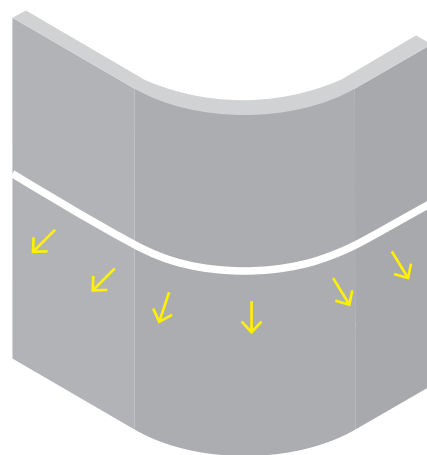

04. Connect.

Mounting scheme with silicone outercase



Countersunk screw
to fix the product
to the installation plane

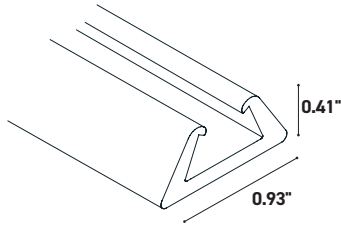

Silicone outercase
to press-in the LED strip

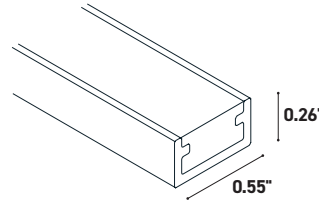

LED strip
extruded in flexible PVC and treated
with polyurethane resin

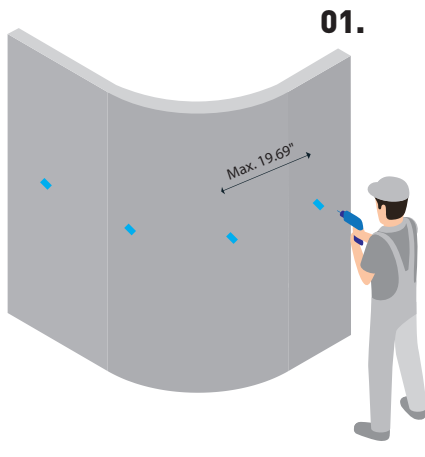
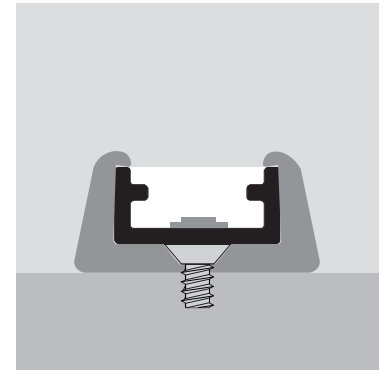

01.



02.

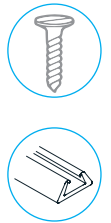
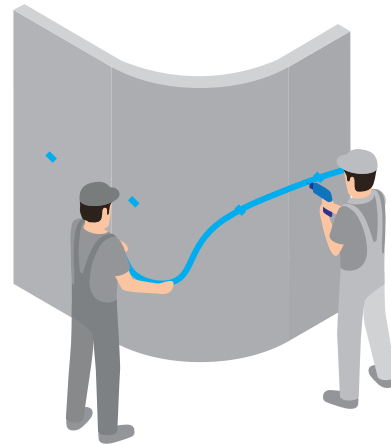

1. Prepare the screw inlet by drilling the installation plan.
2. Pre-drill the silicone outercase with the selected screw diameter.

03. By placing the silicone outercase on the installation plane, fasten it to the same with the countersunk screw.

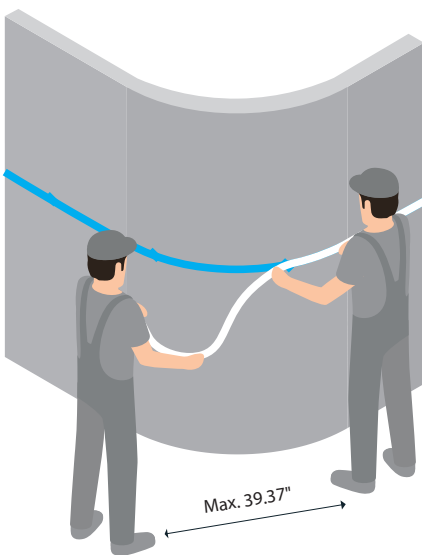

04. Enter the LED strip in the silicone outercase by pressing.

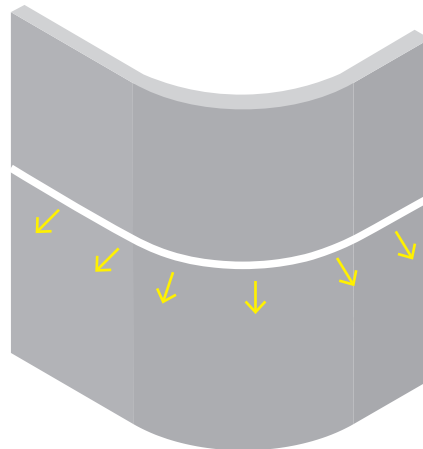

05. Connect.



Mounting scheme with aluminum outercase



Countersunk screw
to fix the product
to the installation plane

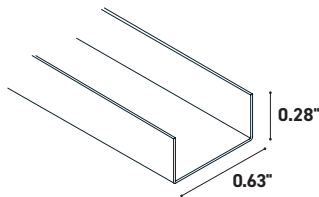

PRO-AL-14x6.5-AL
Aluminum outercase
to press-in the LED strip

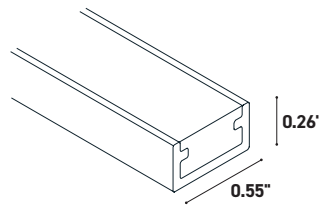

LED strip
extruded in flexible PVC and treated
with polyurethane resin

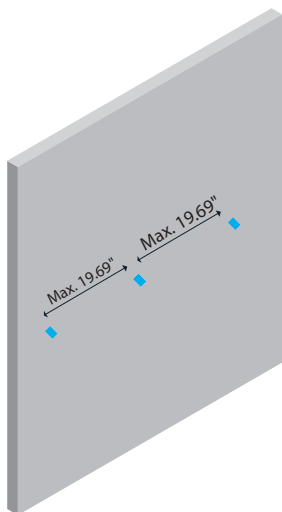
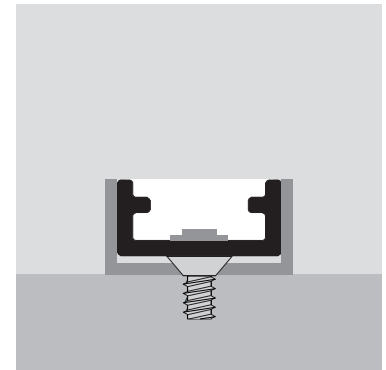

01.



02.

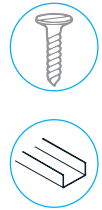
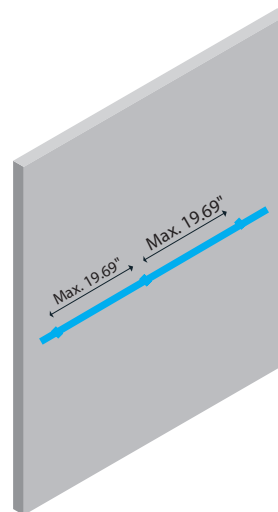

1. Prepare the screw inlet by drilling the installation plan.
2. Pre-drill the aluminum outercase with the selected screw diameter.

3. By placing the aluminum outercase on the installation plane, fasten it to the same with the countersunk screw.

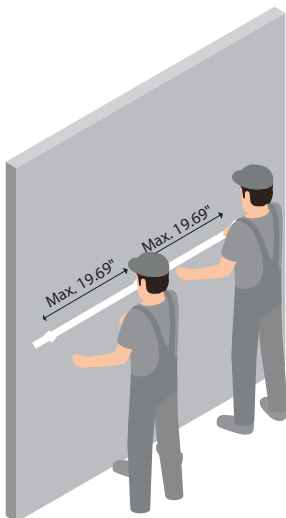

4. Enter the LED strip in the aluminum outercase by pressing.

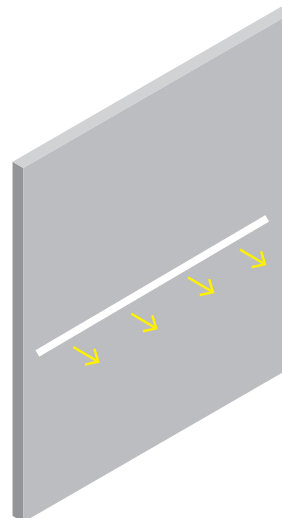

5. Connect.

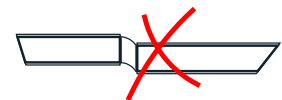

Note. In case of continuous line installation, align the individual light lines to avoid malfunctions of the LED PCB.

Mounting scheme with steel guide



Countersunk screw
to fix the product
to the installation plane

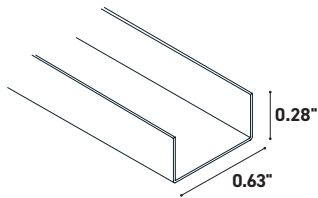

PRO-AC-14x6.5-AC

Steel guide
to insert by pressure
the LED strip

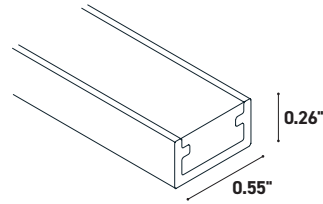

LED strip
extruded in flexible PVC and treated
with polyurethane resin

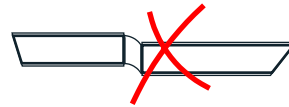
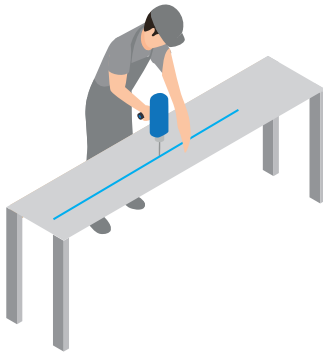
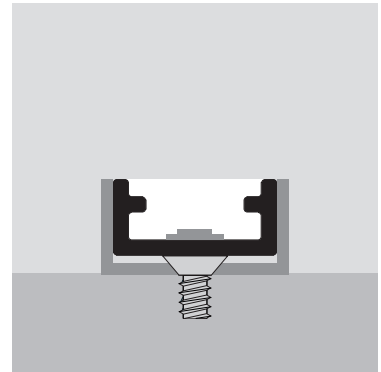

Note. In case of continuous row installation, align the individual light lines well to avoid malfunctions of the LED circuits.



01. Pre-drill the steel profile with the diameter of the chosen screw.

02. Place the steel profile on the installation surface, fixing it to it with the countersunk screw.

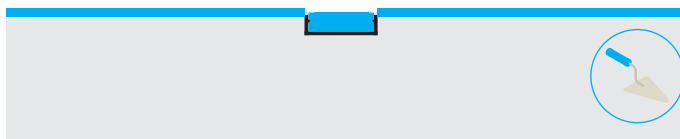

03. Smooth the installation surface.



04. Press the LED strip into the guide and connect the LED Strip.
The strip must be inserted inside with glue, but can be removed in the event of breakage.

Electrical connection scheme

Single end connection, 12VDC max 8.20 ft - 24VDC max 16.40 ft

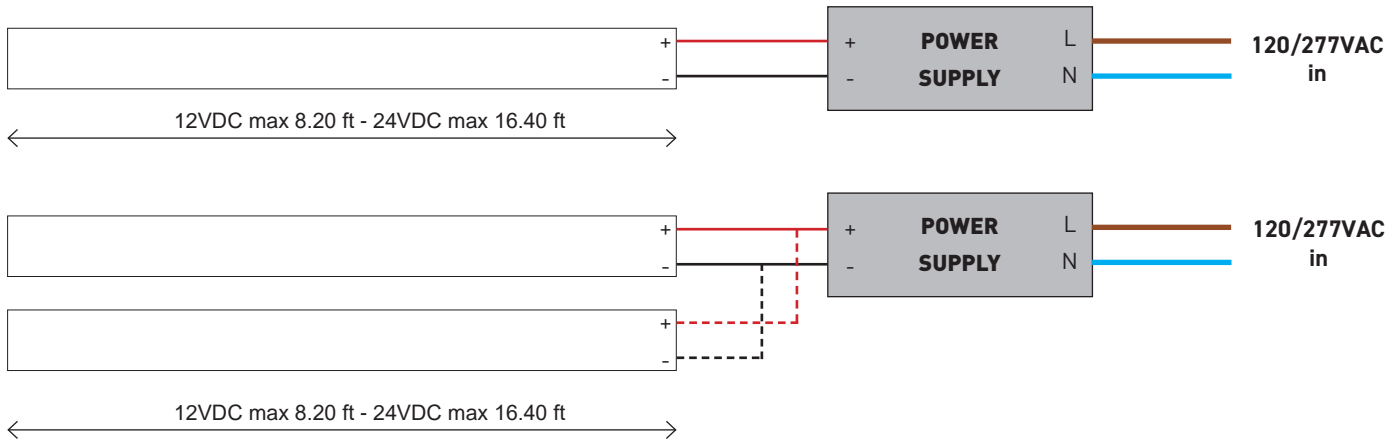

Double end connection, 12VDC max 16.40 ft - 24VDC max 32.81 ft

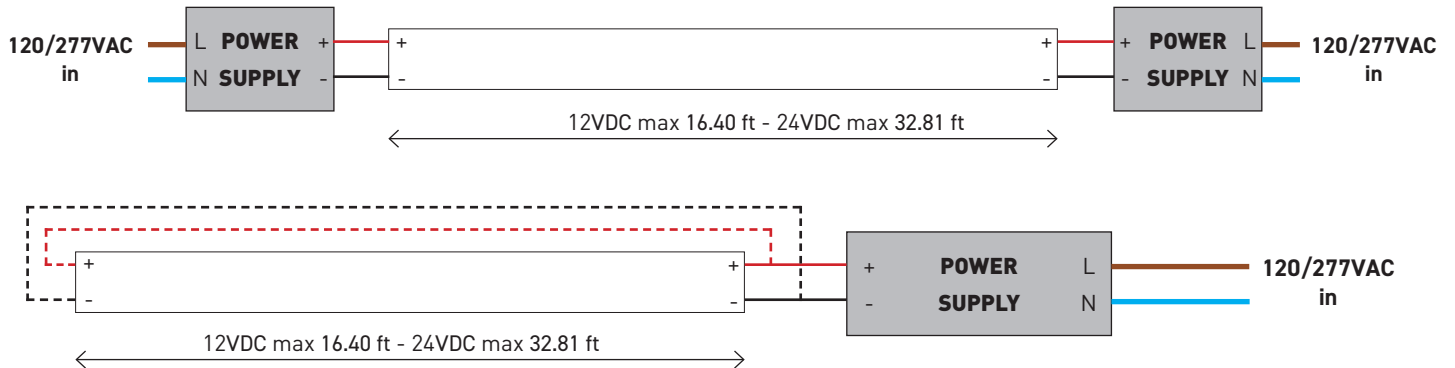

Connection between profiles: continuous line configuration

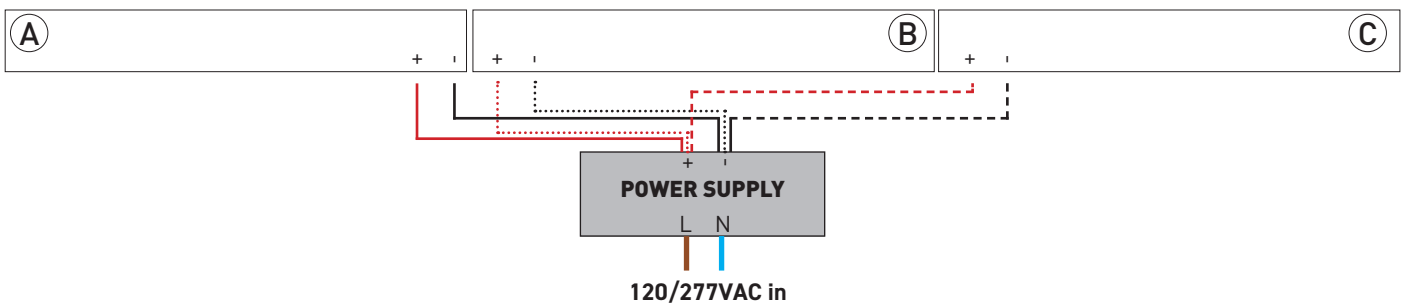

Note. The configured cables have a maximum length. Check on the data sheet.

Dimming scheme

DMX

Code	Voltage	Current	Power	Channel	Control	Source	Dimensions (LxWxH)
DLM1224-1CV DMX	12V	1 x 10A	120W (12V)	1	DMX	Monochrome	1.77"x2.28"x0.75"
	24V		240W (24V)		Button 0-10V / 1-10V Potentiometer		

Monochrome

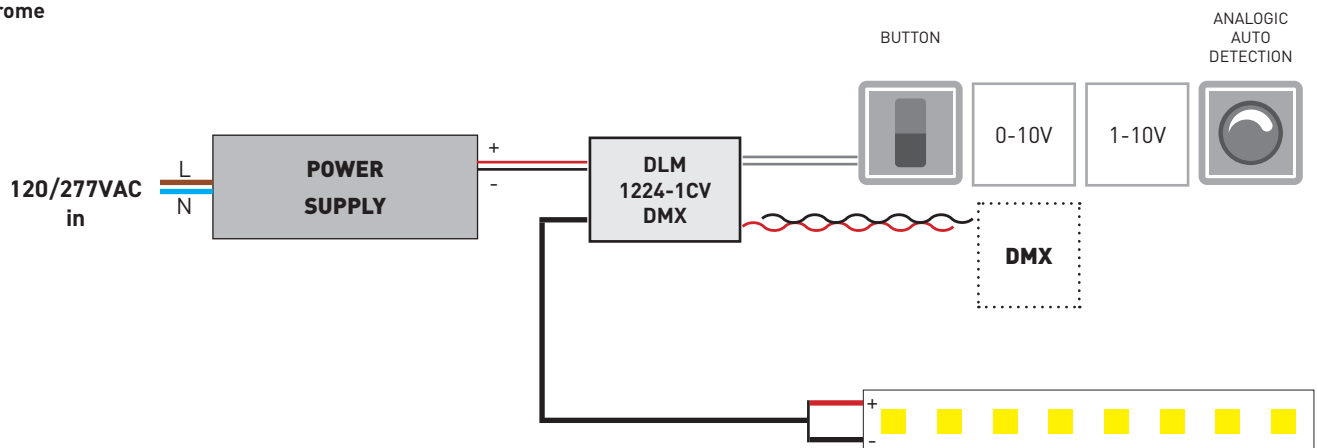

Monochrome + slave

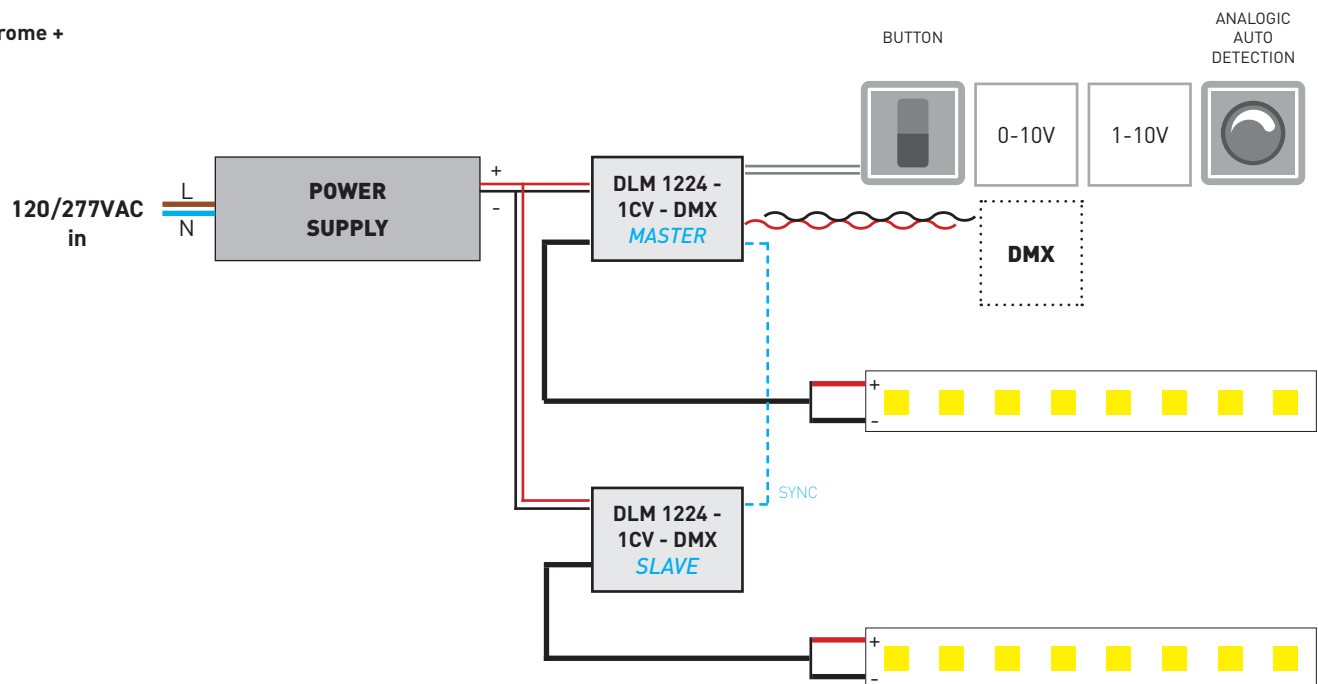

Dimming scheme



Code	Voltage	Current	Power	Channel	Control	Source	Dimensions (LxWxH)
DLC1224-1CV CASAMBI	12V	1 x 10A	120W (12V)	1	App. CASAMBI button	Monochrome	1.77"x2.28"x0.75"
	24V		240W (24V)				

