

EASY LINE - Transparent LLTW3

EASY LINE is a vertical, bendable LED strip that is IP65-IP68 rated ideal for fountains or swimming pools for panel installation in reinforced concrete with tiles or pool liner. It is available in Transparent, Frost, Clear or Total Light with static white, tunable white or RGB, and guarantees protection against UV rays and the corrosive action of salt and sodium hypochlorite. EASY LINE Transparent has a transparent outercasing. **Not cuttable in the field.**



TECHNICAL DATA

Wattage	12W / 3.28 ft (1 m)
Power Supply	Remote Fountain/Pool Approved 24VDC Power Supply, not included. See page 2.
Construction	Body: Transparent Resin Outercase: Transparent UV-treated PVC
CCT	3500K-5900K (120+120 LED / 3.28')
CRI	85
Delivered Lumens	1050 lm / 3.28' (1 m)
Efficacy	87.5 lm/W
Optics	120°
Fixture Dimensions	0.37" w x 0.26" h x Various Lengths
LED Source	SMD 3014
LED Spacing	120+120 LED per 3.28 ft (1 m), 0.17" between LEDs
Lumen Maintenance	L80,B10>50,000 hrs
Color Consistency	2-3-Step MacAdam
Operating Temp.	-22°F to 131°F
IP Rating	IP65 / IP68

Fixture Dimensions

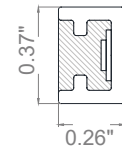
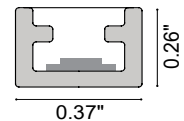

NOT CUTTABLE IN THE FIELD

ORDERING INFORMATION

Example: LLTW3-24.68.T.US Power Supplies / Accessories ordered separately.

LLTW3	-	24	.		.	T	.	US
Model No.		Power		IP Rating				
LLTW3 - 120+120 LED / 3.28' (1 m)		24 - 24VDC		65 - IP65 68 - IP68		T - Transparent		US

Job Name/Date:

Fixture Type Designation:

SUGGESTED POWER SUPPLIES

24VDC - **TO BE USED WITH FOUNTAIN / SWIMMING POOLS**

Part Number	Description	Input/Output	# of Fixtures
FPV-100110024	ELV / TRIAC & 0-10V Dimming (100 to 10%)	120-277VAC to 24VDC, 96W, Class 2, NEMA 4	1-6
FPV-100000024	Non-Dim	120-277VAC to 24VDC, 100W, Class 2, NEMA 4	1-6
FPV-100100024	0-10V Dimming (2 Channels)	120-277VAC to 24VDC, 100W, Class 2, NEMA 4	1-12

SUGGESTED POWER SUPPLIES

24VDC - **TO BE USE FOR INDOOR/OUTDOOR USE - NOT Fountain / Swimming Pool**

Part Number	Description	Input/Output	# of Fixtures
PPLT00056	Non-Dim	120-277VAC to 24VDC, 26W, Class 2, IP66	1-1
PPLT00690	ELV / TRIAC & 0-10V Dimming	120-277VAC to 24VDC, 40W, Class 2, IP67	1-2
PPLT00543	0-10V Dimming to 15% (-40°C / -40°F cold weather start)	120-277VAC to 24VDC, 100W, Class 2	1-6

Suggested Lutron Compatible - **FOR INDOOR/OUTDOOR USE ONLY**

Part Number	Option	Lutron SKU	Dim Range	Description	Input/Output	# of Fixtures
PPLT00273	L3DAE / L3DA3W	L3DA	100%-1%	Hi-Lume™ 1% EcoSystem™ or 1% 3-Wire LED Driver	120-277VAC to 24VDC, 40W, Class 2	1-2
PPLT00530	L3DAE / L3DA3W	L3DA	100%-1%	Hi-Lume™ 1% EcoSystem™ or 1% 3-Wire LED Driver	120-277VAC to 24VDC, 96W, Class 2	1-6

For other power supply options consult factory.

ACCESSORIES - Installation

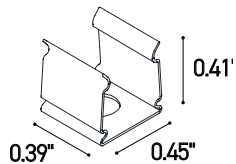

CLIP-AC-9.5x6.5-AC
Harmonic steel clips

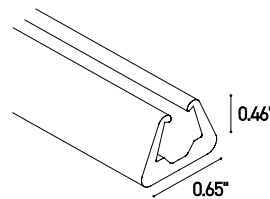
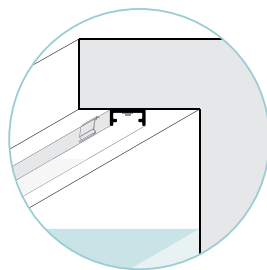

OUT-S-9.5x6.5.F/W
Flexible Silicone Outercase
L=16.4"

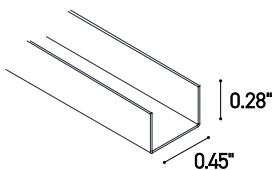
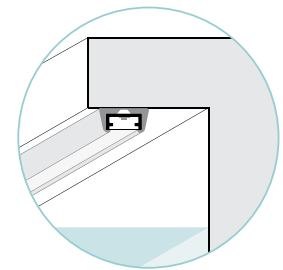

PRO-AL-9.5x6.5-AL
Rigid Aluminum Outercase
L=9.84"

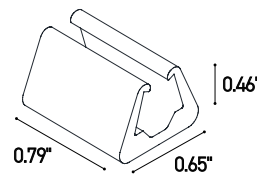
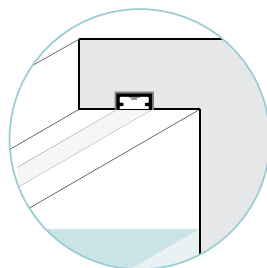

CLIP-S-9.5x6.5.F/W
Silicone Clip

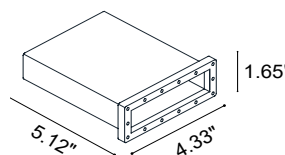

CABLE-BOX
Cable box

Job Name/Date:

Fixture Type Designation:

POWER CABLE EXIT / AREA WITH REDUCED LIGHT

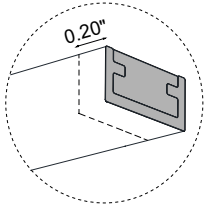

Opposite side

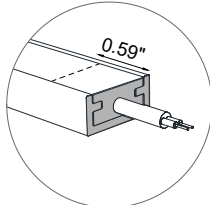

X End feed

CONNECTORS



THB.381.A2A.R

Micro plug and socket connector.
2PIN. male+female.
IP68. Ø0.55" x 3.54".
Compatible for all models except RGB, RGBW and Tunable white.



THB.387.A4A.L.R

Micro plug and socket connector.
4PIN. male+female.
IP68. Ø0.91" x 4.45".
Compatible for all models except RGBW.



THB.391.A4A.L.R

Mini In-line circular joint connector.
4PIN. male+female.
IP68. Ø0.91" x 3.74".
Compatible for all models except RGBW.



THB.402.D4A.R

Connector type "T". 4PIN.
IP68. Ø1.26" x 3.58" x 4.76".
Compatible for all models except RGBW.



THB.209.A4A

Junction box type "H". 4PIN.
IP68. 4.25" x 2.56" x 1.10".
Compatible for all models except RGBW.



THB.399.D4E

Connector type "Y". 4PIN.
IP68. Ø1.26" x 2.48" x 7.09".
Compatible for all models except RGBW.



THB.392.A4A

Connector type "H". 4PIN.
IP68. Ø1.10" x 2.13" x 3.15".
Compatible for all models except RGBW.



THB.390.C1A

Connector type "T". 3PIN.
IP68. Ø1.26" x 3.62" x 2.87".
Compatible for all models except RGB and RGBW.

Job Name/Date:

Fixture Type Designation:

PHOTOMETRIC DATA

1250K

Maximum Candela = 299.3

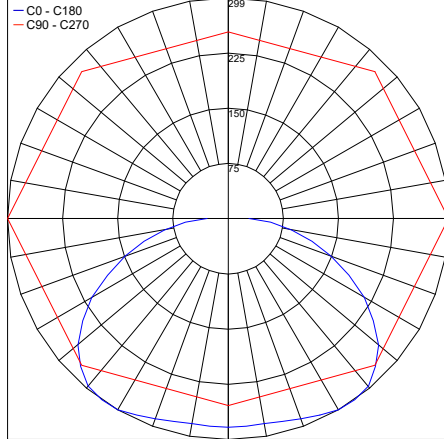

PHOTOMETRIC FILENAME : EASY LINE TRANSPARENT LLTW3-24.68.T.1250K.JES

6000K

Maximum Candela = 147.9

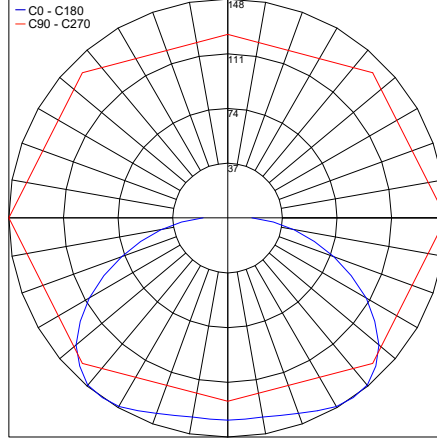

PHOTOMETRIC FILENAME : EASY LINE TRANSPARENT LLTW3-24.68.T.COLD 6000K.JES

Job Name/Date:

Fixture Type Designation: