

# FLEA MINI UNDERWATER

FLEA is a family of IP67-rated round or square recessed wall / in-grade or downlights available in static white, RGBW, and and underwater version (IP68). FLEA MINI Underwater is IP68-rated, and offered round (Ø1.4") or as a floodlight (Ø1.1") with 3 static color temperatures, 4 optics options, and made of ASIS 316L Stainless Steel.



FLEA MINI Underwater Round



FLEA MINI Underwater Spot

Fixture Dimensions - See page 2

## TECHNICAL DATA

<b>Wattage</b>	2W
<b>Power Supply</b>	Remote Fountain/Pool Approved 24VDC Power Supply, not included. See page 2.
<b>Construction</b>	Housing: Anticorodal Aluminum Lens: Extra Clear Tempered Glass
<b>CCT</b>	2700K, 3000K, 4000K
<b>BUG Rating</b>	B0-U0-G0 (3000K)
<b>CRI</b>	>80
<b>Delivered Lumens</b>	150 lm (3000K, 10°)
<b>Efficacy</b>	75 lm/W (3000K, 10°)
<b>Optics</b>	10°, 30°, 14°x20°, Diffuse
<b>Finishes</b>	AISI 316L Stainless Steel
<b>Lumen Maintenance</b>	90,000 hrs, L90 (Ta 35°C)
<b>Fixture Dimensions</b>	See page 2
<b>IP Rating</b>	IP68 (9.84 ft)
<b>Impact Resistance</b>	-

## ORDERING INFORMATION

Example: F50103.6.2.05.US. Power Supplies / Accessories ordered separately.

	6			US
<b>Model No.</b>	<b>Finish</b>	<b>CCT</b>	<b>Optics</b>	
F50103 - Round	6 - AISI 316L Stainless Steel	2 - 2700K	01 - Spot 10°	US
F50132 - Spotlight		3 - 3000K	02 - Medium 30°	
		4 - 4000K	04 - Elliptical 14°x20°	
			05 - Diffused	

Job Name/Date:

Fixture Type Designation:

## FIXTURE DIMENSIONS

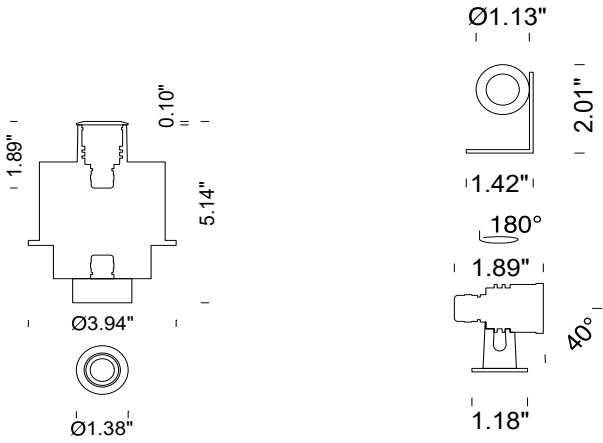

FLEA MINI Underwater Round

FLEA MINI Underwater Spot

## SUGGESTED POWER SUPPLIES

24VDC

Part Number	Description	Input/Output	# of Fixtures
<a href="#">FPV-100110024</a>	ELV / TRIAC & 0-10V Dimming (100 to 0%)	120-277VAC to 24VDC, 96W, Class 2, NEMA 4	1-38
<a href="#">FPV-100000024</a>	Non-Dim	120-277VAC to 24VDC, 100W, Class 2, NEMA 4	1-40
<a href="#">FPV-100100024</a>	0-10V Dimming (2 channels)	120-277VAC to 24VDC, 100W, Class 2, NEMA 4	1-80

For other power supply options consult factory.

Job Name/Date:

Fixture Type Designation:

## PHOTOMETRIC DATA

Note: All photometry is 3000K

### ROUND

Maximum Candela = 1397.5

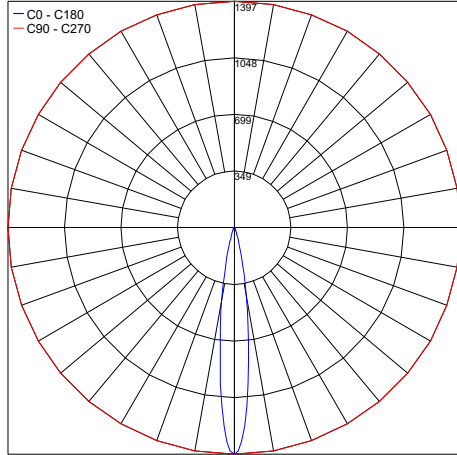

PHOTOMETRIC FILENAME : FLEA MINI UNDERWATER RD 30K 10°-50103.X.3.01.IES

Maximum Candela = 1139.6

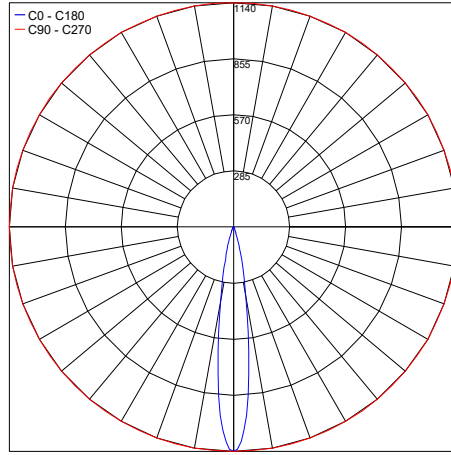

PHOTOMETRIC FILENAME : FLEA MINI UNDERWATER RD 30K 14°X20°-50103.X.3.04.IES

Maximum Candela = 505.5

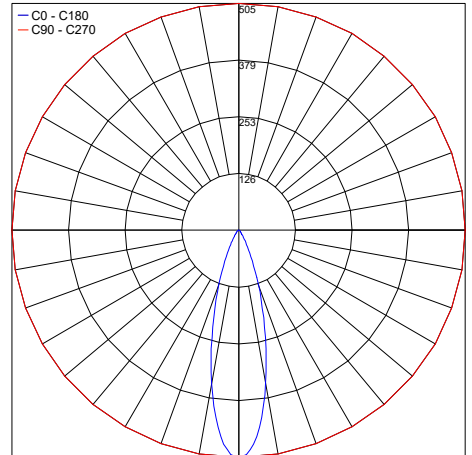

PHOTOMETRIC FILENAME : FLEA MINI UNDERWATER RD 30K 30°-50103.X.3.02.IES

### SPOTLIGHT

Maximum Candela = 1397.5

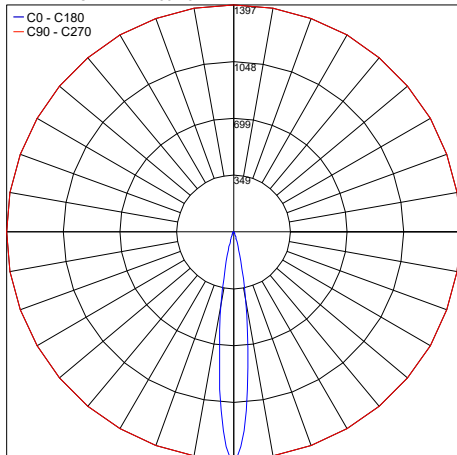

PHOTOMETRIC FILENAME : FLEA MINI UNDERWATER SPOT 30K 10°-50132.X.3.01.IES

Maximum Candela = 1139.6

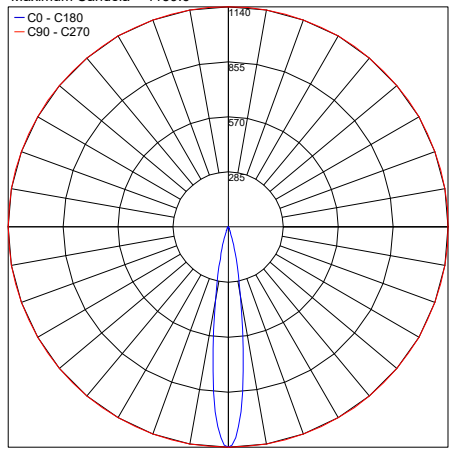

PHOTOMETRIC FILENAME : FLEA MINI UNDERWATER SPOT 30K 14°X20°-50132.X.3.04.IES

Maximum Candela = 505.5

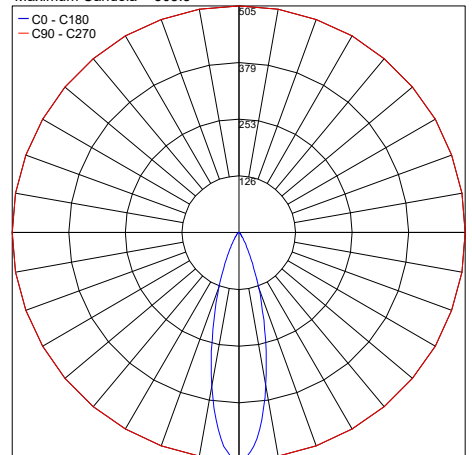

PHOTOMETRIC FILENAME : FLEA MINI UNDERWATER SPOT 30K 30°-50132.X.3.02.IES

Job Name/Date:

Fixture Type Designation: