

# KRILL 4.5

Krill is a small, adjustable zoom, surface mounted floodlight with a pared-down design for indoor applications. The fixture is ideal for inside shop windows and display cabinets in retail and museum environments. Krill can be installed in a variety of ways to easily reach details that need emphasizing with a double-jointed arm that can be adjusted by up to 180°. Krill 4.5 is 3.0" in diameter with 9W power and a light shaper optic.



## TECHNICAL DATA

<b>Wattage / Input</b>	9W (250mA)
<b>Power Supply</b>	Remote, not included. See page 2.
<b>Construction</b>	Body: Anticorodal Aluminum Joint: Brass Cable Length: 4.92'
<b>CCT</b>	2700K, 3000K, 4000K
<b>CRI</b>	>90
<b>Delivered Lumens</b>	315 lm (3000K, 54°)
<b>Efficacy</b>	35 lm/W (3000K, 54°)
<b>Optics</b>	Light Shaper
<b>Finishes</b>	4 Standard, Custom RAL on request (see below)
<b>Fixture Dimensions</b>	3.03" x 5.79" h
<b>Base Size</b>	Ø0.51"
<b>Fixture Weight</b>	0.88 lbs
<b>LED Source</b>	1 COB LED
<b>Lumen Maintenance</b>	L90, B10 >60,000hrs (Ta 25°C)
<b>Color Consistency</b>	2-step MacAdam
<b>Operating Temp.</b>	32°F to +113°F
<b>IP Rating</b>	IP40

Fixture Dimensions

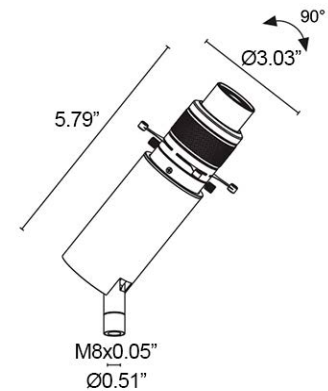

**Required installation accessories, not included. See page 2.**

## ORDERING INFORMATION

Example: **KI452010005R9Y**. Power Supplies / Required Accessories ordered separately.

KI45201000		R9	
<b>Model No.</b>	<b>CCT</b>	<b>Optics</b>	<b>Finish</b>
KI45201000	F - 2700K 5 - 3000K 9 - 4000K	R9 - Light Shaper	E - White N - Black Y - Rose Gold Z - Antique Bronze C - Custom RAL (Consult factory for "C")

Job Name/Date:

Fixture Type Designation:

## SUGGESTED POWER SUPPLIES

250mA

Part Number	Description	Input/Output	# of Fixtures
<a href="#">PPLT00466-P</a>	0-10V Dimming to 1.0%	120-277VAC to 250mA, 10W, Class 2, DAMP	1-1
<a href="#">PPLT00290</a>	Leading/Trailing Edge Dimming to 10% (120V only)	120-277VAC to 250mA, 16W, Class 2, DAMP	1-1
<a href="#">PPLT00480-P</a>	0-10V Dimming to 1.0%	120-277VAC to 250mA, 30W, Class 2, DAMP	1-1
<a href="#">PPLT00467-P</a>	0-10V Dimming to 1.0%	120-277VAC to 250mA, 50W, Class 2, DAMP	1-1
<a href="#">PPLT00538-P</a>	0-10V Dimming to 0.1%	120-277VAC to 250mA, 100W, Class 2	1-4

*For other power supply options consult factory.*

Job Name/Date:

Fixture Type Designation:

## ACCESSORIES - Installation (REQUIRED, NOT INCLUDED)

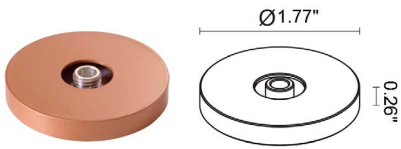

**WDA06B** - White  
**WDA06N** - Black  
**WDA06Y** - Rose Gold  
**WDA06Z** - Antique Bronze  
 Fixing Base

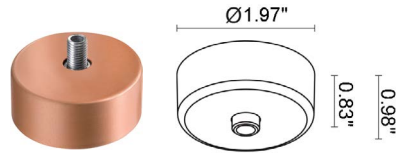

**WDA10B** - White  
**WDA10N** - Black  
**WDA10Y** - Rose Gold  
**WDA10Z** - Antique Bronze  
 Ceiling Rose

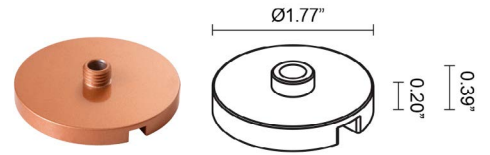

**WDA07B** - White  
**WDA07N** - Black  
**WDA07Y** - Rose Gold  
**WDA07Z** - Antique Bronze  
 Magnetic Plate

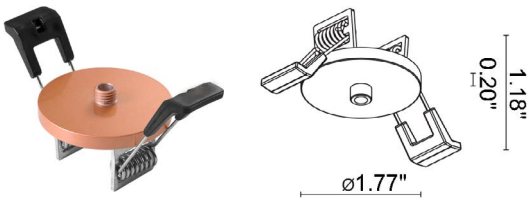

**WGA09B** - White  
**WGA09N** - Black  
**WGA09Y** - Rose Gold  
**WGA098Z** - Antique Bronze  
 Retaining Spring Clip  $\varnothing 1.77$ "

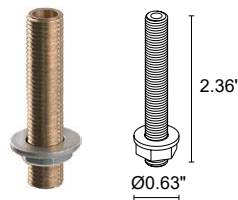

**WGA01**  
 Coupler

## ACCESSORIES - Spikes and Arms

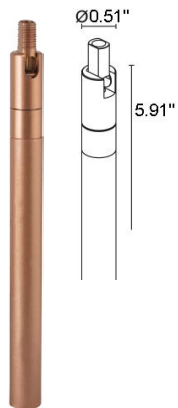

**WDA08B\*** - White  
**WDA08N\*** - Black  
**WDA08Y\*** - Rose Gold  
**WDA08Z\*** - Antique Bronze  
 Rigid arm - 5.91" height  
*\*order together with the part WDA06\_ or with the part WGA01*

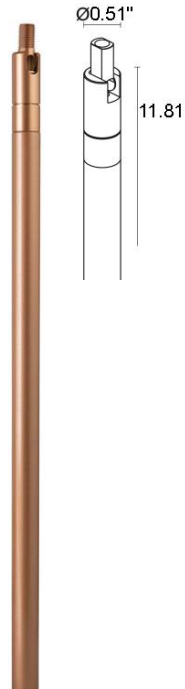

**WDA09B\*** - White  
**WDA09N\*** - Black  
**WDA09Y\*** - Rose Gold  
**WDA09Z\*** - Antique Bronze  
 Rigid arm - 11.81" height  
*\*order together with the part WDA06\_ or with the part WGA01*

Job Name/Date:

Fixture Type Designation:

## ACCESSORIES - Cables

### WF0110

PVC Cable FROR 2x0.35 3.5mm (0.14")

Your choice of length

## PHOTOMETRIC DATA

Note all Photometry is 3000K

Light Shaper Circle

Maximum Candela = 629.6

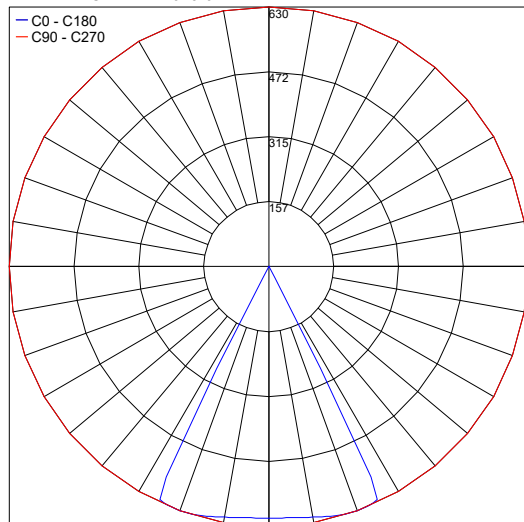

PHOTOMETRIC FILENAME : KRILL\_4.5\_SHAPER\_CIRCLE\_3000K\_9W\_250MA.IES

Job Name/Date:

Fixture Type Designation: