

ELITE is a family of linear profiles with 4 different installation variants that use a specifically designed optic, the Bartenbach LFO lens, that hides the light source which shines through a small hole, minimizing glare effect and providing the functionality of a standard lens. ELITE C is the ceiling mounted version that comes in 7 lengths and 4 standard finishes.



TECHNICAL DATA

| | |
|---------------------------|--|
| Wattage | 2.2W (1 C), 4.5W (2 C), 6.7W (3 C), 11.2W (5 C), 17.9W (8 C), 22.4W (10 C), 26.9W (12 C) |
| Power Supply | Remote 700mA, not included. See page 3 |
| Construction | Body: Extruded Aluminum Lens: Anti-glare Black Louver |
| CCT | 3000K, 4000K |
| CRI | >80 |
| Delivered Lumens | See chart on page 2 |
| Efficacy | See chart on page 2 |
| Optics | 30°, 60° (UGR<19) |
| LED Source | High Output PCB LED |
| Lumen Maintenance | 50,000 hrs L80, B10 (Ta 25°C) |
| Color Consistency | 3-Step MacAdam |
| Finishes | White, Black, Fog, Graphite |
| Fixture Dimensions | See chart on page 2 |
| IP Rating | IP20 |

Fixture Dimensions

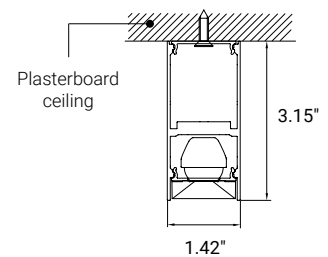

ORDERING INFORMATION

Example: IO5.3001.01C1.027M.40.US. Power Supplies / Accessories sold separately.

| | 0 | | | | .US |
|---|--|-----------|----------|-------------------------|-----|
| Model No. | Driver | CCT | Optic | Finish | |
| IO5.3001.01C1 - Elite 1 C, 2.2W, 1.54" | 0 - Remote | 2 - 3000K | 7M - 30° | 40 - White (RAL9016) | .US |
| IO5.3001.02C1 - Elite 2 C, 4.5W, 2.80" | <i>NOTE: Must be ordered separately - see page 3</i> | 3 - 4000K | 7W - 60° | 50 - Black (RAL9005) | |
| IO5.3001.03C1 - Elite 3 C, 6.7W, 4.06" | | | | G0 - Fog (RAL7038) | |
| IO5.3001.05C1 - Elite 5 C, 11.2W, 6.57" | | | | H0 - Graphite (RAL7024) | |
| IO5.3001.08C1 - Elite 8 C, 17.9W, 10.35" | | | | | |
| IO5.3001.10C1 - Elite 10 C, 22.4W, 12.87" | | | | | |
| IO5.3001.12C1 - Elite 12 C, 26.9W, 15.39" | | | | | |

Job Name/Date:

Fixture Type Designation:

TECHNICAL DATA

| | Elite 1 C | | Elite 2 C | | Elite 3 C | | Elite 5 C | |
|---------------------------------|-----------------------|--------------|-----------------------|--------------|-----------------------|--------------|-----------------------|---------------|
| Wattage | 2.2W | | 4.5W | | 6.7W | | 11.2W | |
| Delivered Lumens (4000K) | 195 lm (30°) | 200 lm (60°) | 390 lm (30°) | 400 lm (60°) | 585 lm (30°) | 600 lm (60°) | 975 lm (30°) | 1000 lm (60°) |
| Efficacy | 88.6 lm/W | 90.9 lm/W | 86.7 lm/W | 88.9 lm/W | 87.3 lm/W | 89.6 lm/W | 87.1 lm/W | 89.3 lm/W |
| Fixture Dim. (l,w,h) | 1.54" x 1.42" x 3.15" | | 2.80" x 1.42" x 3.15" | | 4.06" x 1.42" x 3.15" | | 6.57" x 1.42" x 3.15" | |

| | Elite 8 C | | Elite 10 C | | Elite 12 C | | UGR<19 |
|---------------------------------|------------------------|---------------|------------------------|---------------|------------------------|---------------|------------------|
| Wattage | 17.9W | | 22.4W | | 26.9W | | |
| Delivered Lumens (4000K) | 1560 lm (30°) | 1600 lm (60°) | 1950 lm (30°) | 2000 lm (60°) | 2340 lm (30°) | 2400 lm (60°) | |
| Efficacy | 87.2 lm/W | 89.4 lm/W | 87.1 lm/W | 89.3 lm/W | 87.0 lm/W | 89.2 lm/W | |
| Fixture Dim. (l,w,h) | 10.35" x 1.42" x 3.15" | | 12.87" x 1.42" x 3.15" | | 15.39" x 1.42" x 3.15" | | |

ELITE C FIXTURE DIMENSIONS

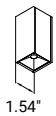

1.54"

Elite 1 C

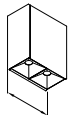

2.80"

Elite 2 C

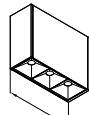

4.06"

Elite 3 C

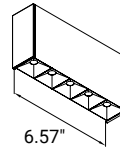

6.57"

Elite 5 C

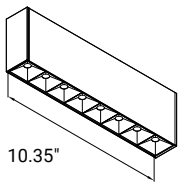

10.35"

Elite 8 C

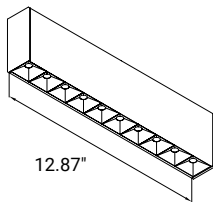

12.87"

Elite 10 C

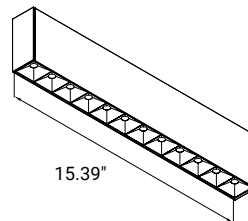

15.39"

Elite 12 C

HOUSING COLORS

-  white (RAL9016)
-  fog (RAL7038)
-  graphite (RAL7024)
-  black (RAL9005)

ACCESSORIES

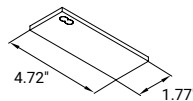

4.72" x 1.77"

5.3020.0100.0000.40

Driver Cover

4.72" x 1.77"

Recommended for Elite 1, 2, 3 and 5

Job Name/Date:

Fixture Type Designation:

SUGGESTED POWER SUPPLIES

700mA - For 2.2W, 4.5W, and 6.7W

| Part Number | Description | Input/Output | # of Fixtures | | |
|-----------------------------|--|---|---------------|------|------|
| | | | 2.2W | 4.5W | 6.7W |
| PPLT00537 | Non Dim | 120-277VAC to 700mA, 4W, Class 2 | 1-1 | - | - |
| PPLT00470 | Phase Dim (120V only) | 120VAC to 700mA, 14W, Class 2 | 3-6 | 2-3 | 1-2 |
| PPLT00465-P | 0-10V Dimming to 1.0% | 120-277VAC to 700mA, 20W, Class 2, DAMP | 1-9 | 1-4 | 1-3 |
| PPLT00261 | Leading / Trailing Edge Dimming to 10% (120V only) | 120VAC to 700mA, 32W, Class 2 | 7-15 | 4-7 | 3-5 |
| PPLT00467-P | 0-10V Dimming to 1.0% | 120-277VAC to 700mA, 50W, Class 2, DAMP | 1-18 | 1-9 | 1-6 |
| PPLT00538-P | 0-10V Dimming to 0.1% (4 channels) | 120-277VAC to 700mA, 100W, Class 2 | 1-44 | 1-20 | 1-12 |

Suggested Lutron Compatible - For 2.2W, 4.5W, and 6.7W

| Part Number | Option | Lutron SKU | Dim Range | Description | Input/Output | # of Fixtures | | |
|---------------------------|----------------|------------|-----------|--|-----------------------------------|---------------|------|------|
| | | | | | | 2.2W | 4.5W | 6.7W |
| PPLT00515 | L3DAE / L3DA3W | L3DA | 100%-1% | Hi-Lume™ 1% EcoSystem™ or 1% 3-Wire LED Driver | 120-277VAC to 700mA, 14W, Class 2 | 3-6 | 2-3 | 1-2 |
| PPLT00579 | LDE1E | LDE1 | 100%-1% | Hi-Lume™ 1% EcoSystem™ Soft On F2B | 120-277VAC to 700mA, 16W, Class 2 | 5-7 | 3-3 | 2-2 |
| PPLT00635 | PEQ0E | PEQ0 | 100%-0.1% | Hi-Lume™ Premier 0.1% EcoSystem™ F2B | 120-277VAC to 700mA, 20W, Class 2 | 4-9 | 2-4 | 2-3 |
| PPLT00673 | PEQ0E | PEQ0 | 100%-0.1% | Hi-Lume™ Premier 0.1% EcoSystem™ F2B | 120-277VAC to 700mA, 20W, Class 2 | 4-9 | 2-4 | 2-3 |
| PPLT00517 | L3DAE / L3DA3W | L3DA | 100%-1% | Hi-Lume™ 1% EcoSystem™ or 1% 3-Wire LED Driver | 120-277VAC to 700mA, 27W, Class 2 | 6-12 | 3-6 | 2-4 |
| PPLT00181 | L3DAE / L3DA3W | L3DA | 100%-1% | Hi-Lume™ 1% EcoSystem™ or 1% 3-Wire LED Driver | 120-277VAC to 700mA, 38W, Class 2 | 11-17 | 6-8 | 4-5 |

SUGGESTED POWER SUPPLIES

700mA - For 11.2W, 17.9W, 22.4W, and 26.9W

| Part Number | Description | Input/Output | # of Fixtures | | | |
|-----------------------------|--|---|---------------|-------|-------|-------|
| | | | 11.2W | 17.9W | 22.4W | 26.9W |
| PPLT00470 | Phase Dim (120V only) | 120VAC to 700mA, 14W, Class 2 | 1-1 | - | - | - |
| PPLT00465-P | 0-10V Dimming to 1.0% | 120-277VAC to 700mA, 20W, Class 2, DAMP | 1-1 | 1-1 | - | - |
| PPLT00261 | Leading / Trailing Edge Dimming to 10% (120V only) | 120VAC to 700mA, 32W, Class 2 | 2-3 | 1-1 | 1-1 | 1-1 |
| PPLT00467-P | 0-10V Dimming to 1.0% | 120-277VAC to 700mA, 50W, Class 2, DAMP | 1-3 | 1-2 | 1-1 | 1-1 |
| PPLT00538-P | 0-10V Dimming to 0.1% (4 channels) | 120-277VAC to 700mA, 100W, Class 2 | 1-8 | 1-4 | 1-4 | - |

Suggested Lutron Compatible - For 11.2W, 17.9W, 22.4W, and 26.9W

| Part Number | Option | Lutron SKU | Dim Range | Description | Input/Output | # of Fixtures | | | |
|---------------------------|----------------|------------|-----------|--|-----------------------------------|---------------|-------|-------|-------|
| | | | | | | 11.2W | 17.9W | 22.4W | 26.9W |
| PPLT00515 | L3DAE / L3DA3W | L3DA | 100%-1% | Hi-Lume™ 1% EcoSystem™ or 1% 3-Wire LED Driver | 120-277VAC to 700mA, 14W, Class 2 | 1-1 | - | - | - |
| PPLT00579 | LDE1E | LDE1 | 100%-1% | Hi-Lume™ 1% EcoSystem™ Soft On F2B | 120-277VAC to 700mA, 16W, Class 2 | 1-1 | - | - | - |
| PPLT00635 | PEQ0E | PEQ0 | 100%-0.1% | Hi-Lume™ Premier 0.1% EcoSystem™ F2B | 120-277VAC to 700mA, 20W, Class 2 | 1-1 | 1-1 | - | - |
| PPLT00673 | PEQ0E | PEQ0 | 100%-0.1% | Hi-Lume™ Premier 0.1% EcoSystem™ F2B | 120-277VAC to 700mA, 20W, Class 2 | 1-1 | 1-1 | - | - |
| PPLT00517 | L3DAE / L3DA3W | L3DA | 100%-1% | Hi-Lume™ 1% EcoSystem™ or 1% 3-Wire LED Driver | 120-277VAC to 700mA, 27W, Class 2 | 2-2 | 1-1 | 1-1 | 1-1 |
| PPLT00181 | L3DAE / L3DA3W | L3DA | 100%-1% | Hi-Lume™ 1% EcoSystem™ or 1% 3-Wire LED Driver | 120-277VAC to 700mA, 38W, Class 2 | 3-3 | 2-2 | - | 1-1 |

For other power supply options consult factory.

Job Name/Date:

Fixture Type Designation:

PHOTOMETRIC DATA - Note: All Photometry is 3000K - Medium Beam 30°

Maximum Candela = 792

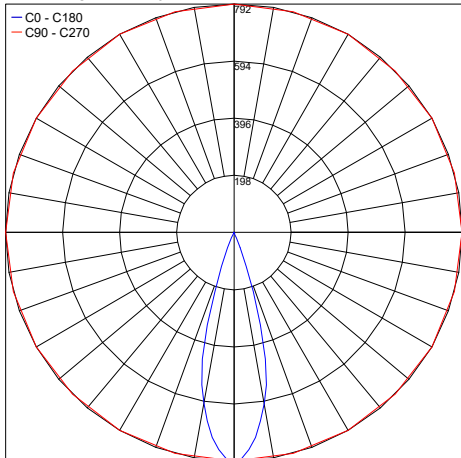

PHOTOMETRIC FILENAME : ELITE_C_3000K_MEDIUM_BEAM_CC_HO_1.5IN.IES

Maximum Candela = 1584

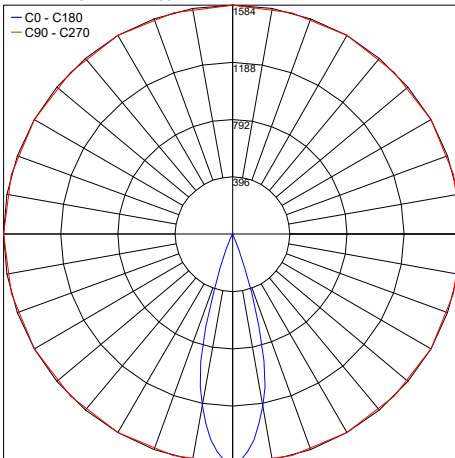

PHOTOMETRIC FILENAME : ELITE_C_3000K_MEDIUM_BEAM_CC_HO_2.8IN.IES

Maximum Candela = 2376

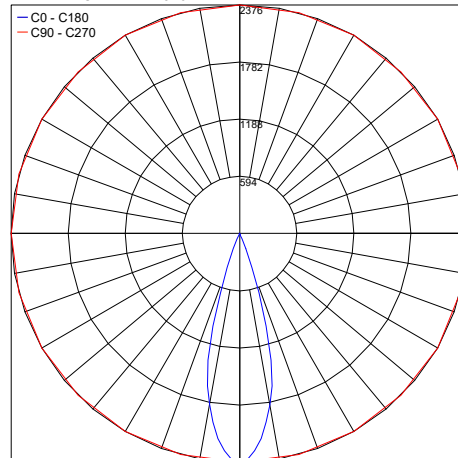

PHOTOMETRIC FILENAME : ELITE_C_3000K_MEDIUM_BEAM_CC_HO_4.0IN.IES

Maximum Candela = 3959.9

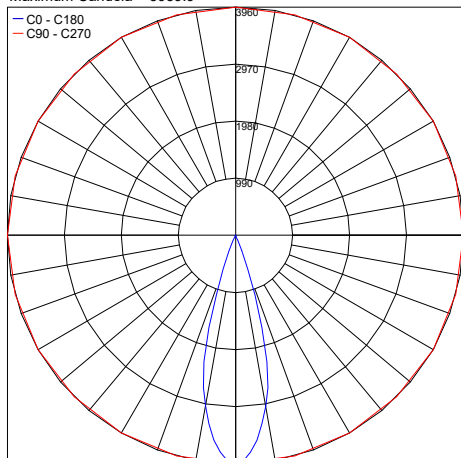

PHOTOMETRIC FILENAME : ELITE_C_3000K_MEDIUM_BEAM_CC_HO_6.6IN.IES

Maximum Candela = 6335.9

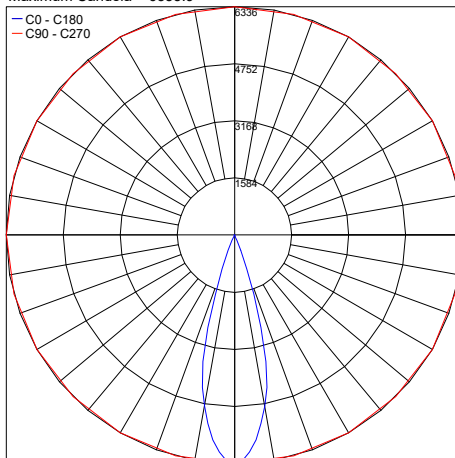

PHOTOMETRIC FILENAME : ELITE_C_3000K_MEDIUM_BEAM_CC_HO_10.4IN.IES

Maximum Candela = 7919.8

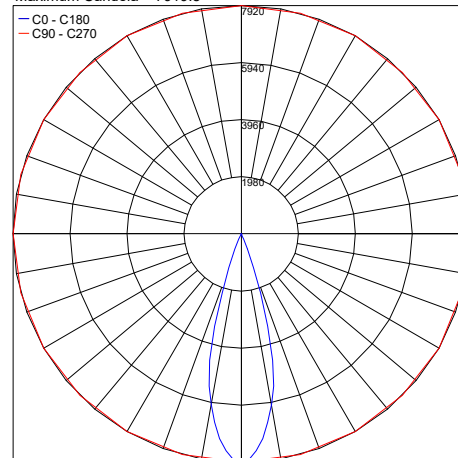

PHOTOMETRIC FILENAME : ELITE_C_3000K_MEDIUM_BEAM_CC_HO_12.9IN.IES

Maximum Candela = 9503.8

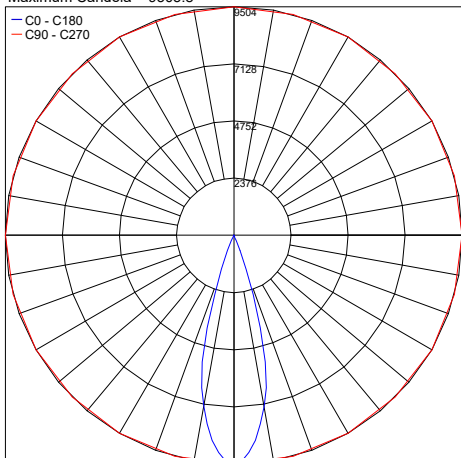

PHOTOMETRIC FILENAME : ELITE_C_3000K_MEDIUM_BEAM_CC_HO_15.4IN.IES

Job Name/Date:

Fixture Type Designation:

PHOTOMETRIC DATA - Note: All Photometry is 3000K - Wide Beam 60°

Maximum Candela = 244.7

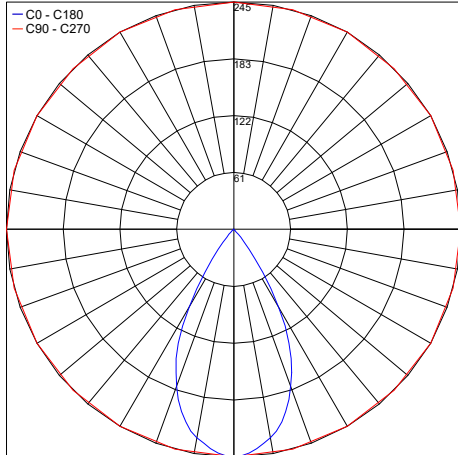

PHOTOMETRIC FILENAME : ELITE_C_3000K_WIDE_BEAM_CC_HO_1.5IN.IES

Maximum Candela = 489.3

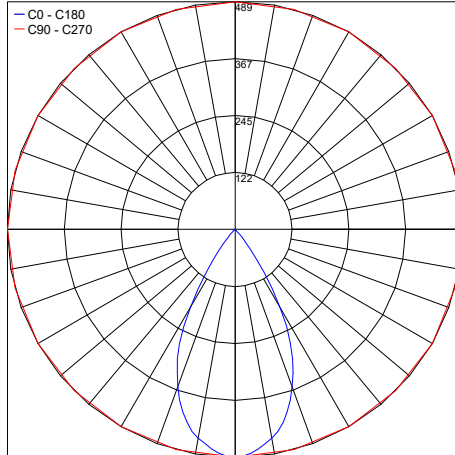

PHOTOMETRIC FILENAME : ELITE_C_3000K_WIDE_BEAM_CC_HO_2.8IN.IES

Maximum Candela = 733.9

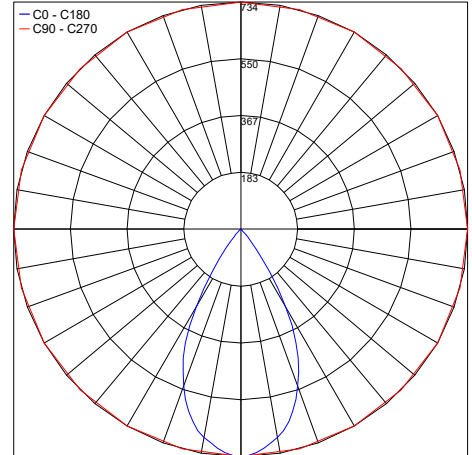

PHOTOMETRIC FILENAME : ELITE_C_3000K_WIDE_BEAM_CC_HO_4.0IN.IES

Maximum Candela = 1223.2

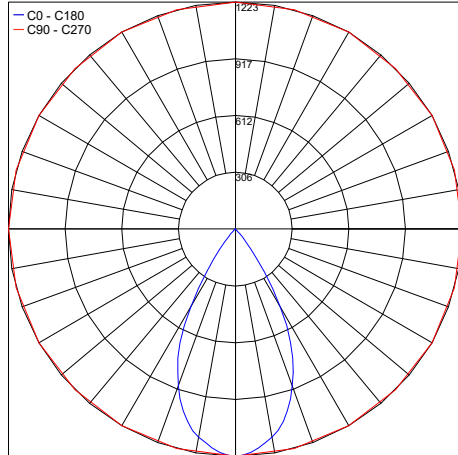

PHOTOMETRIC FILENAME : ELITE_C_3000K_WIDE_BEAM_CC_HO_6.6IN.IES

Maximum Candela = 1957.2

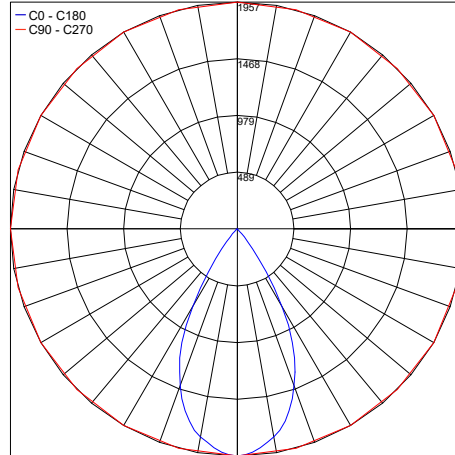

PHOTOMETRIC FILENAME : ELITE_C_3000K_WIDE_BEAM_CC_HO_10.4IN.IES

Maximum Candela = 2446.5

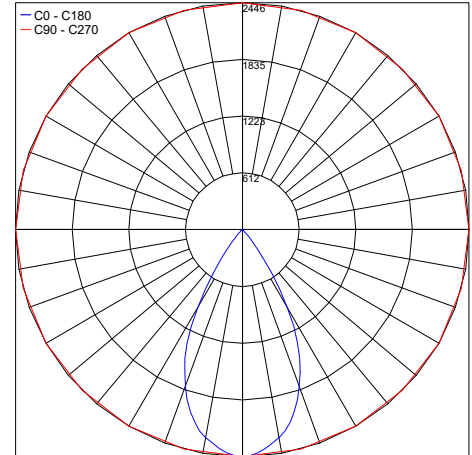

PHOTOMETRIC FILENAME : ELITE_C_3000K_WIDE_BEAM_CC_HO_12.9IN.IES

Maximum Candela = 2935.8

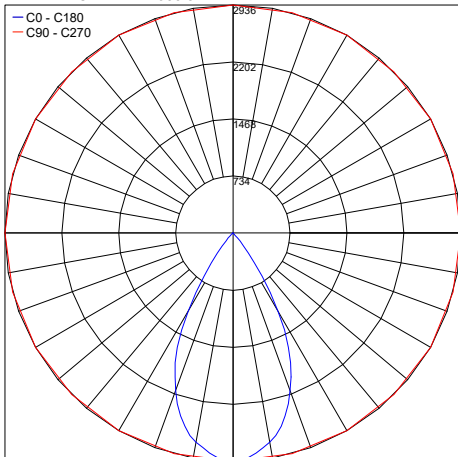

PHOTOMETRIC FILENAME : ELITE_C_3000K_WIDE_BEAM_CC_HO_15.4IN.IES

Job Name/Date:

Fixture Type Designation: