

OLIVER 1.3

Oliver is a family of outdoor floodlights with high performance and a pared-down design for lighting large facades, public spaces and areas. They are available in 3 sizes (Ø7.1", Ø9.1", Ø11.8") with a wide variety of white-light optics, including a very narrow 5° version, as well as an RGBW version which includes a narrow 10° beam. Oliver 1.3 is the Ø7.1" RGBW version.



TECHNICAL DATA

Wattage	39W
Power Supply	Integral 120-277VAC
Dimming	DMX
Construction	Body: Anticorodal Aluminum Lens: 0.31"-Thick Tempered Extra-clear Glass
CCT	RGBW
BUG Rating	B2-U0-G0 B1-U0-G0 (3000K - 34°, 11°x66°) B2-U1-G0 (RGBW - 11°x66°)
Delivered Lumens	3077 lm: (R) 496 lm, (G) 1024 lm, (B) 271 lm, (W) 1286 lm (3000K, 10°)
Efficacy	78.9 lm/W: (R) 12.7 lm/W, (G) 26.3 lm/W, (B) 6.9 lm/W, (W) 33.0 lm/W (3000K, 10°)
Optics	5 Standard (see below)
Finishes	Anthracite, Corten, Gray, White, Custom RAL (4 Stage Marine Grade Finish)
Fixture Dimensions	Ø7.09"x 10.71" x 4.69"
Fixture Weight	8.82 lbs
LED Source	4 High Intensity Multicolor LEDs
Lumen Maintenance	L80, B10 >60,000hrs (Ta 25°C)
Operating Temp.	-4°F to +113°F
IP Rating	IP66
Impact Rating	IK09

Fixture Dimensions

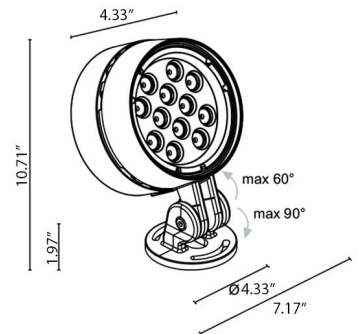

ORDERING INFORMATION

Example: LV1310N40070SH-1. Accessories ordered separately.

LV131	0N4		7			-	1
Model No.		Optical Accessory	CCT	Optics	Finish		Cable Length
LV131	0N4	00 - No accessory 01 - Honeycomb NOTE: Honeycomb Louver not available for 10°x65° adjustable version.	7 - RGBW	0S - 10° 0M - 24° 0L - 34° 0K - 55° 0X - 11°x66° adjustable NOTE: Honeycomb Louver not available for 11°x66° adjustable	H - Anthracite T - Corten F - Gray E - White C - Custom RAL (Consult factory for "C")		1 - 16.40'

Job Name/Date:

Fixture Type Designation:

ACCESSORIES - Anti-Glare

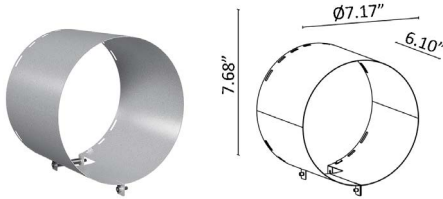

WBA18_

Standard Snoot

Choose one of the below finishes:

- E - White
- F - Gray
- H - Anthracite
- T - Cor-ten

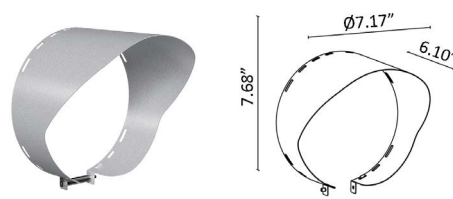

WBA19_

Asymmetric Snoot

Choose one of the below finishes:

- E - White
- F - Gray
- H - Anthracite
- T - Cor-ten

ACCESSORIES - Installation

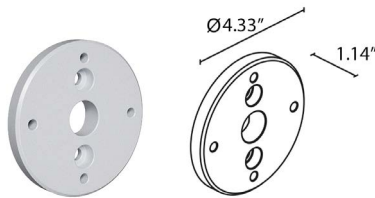

WPA12_

Flange for 3.0" Pole Installation - **Ø2.36"**

Choose one of the below finishes:

- E - White
- F - Gray
- H - Anthracite
- T - Cor-ten

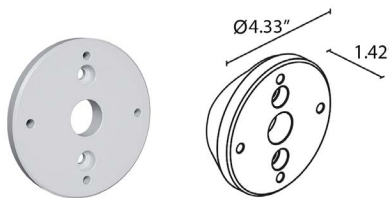

WPA13_

Flange for 4.0" Pole Installation - **Ø3.50"**

Choose one of the below finishes:

- E - White
- F - Gray
- H - Anthracite
- T - Cor-ten

ACCESSORIES

Controllers (RGBW)

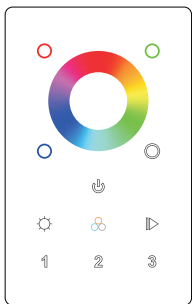

PPWD00570 - RGBW DMX512+Wifi Controller

Touch Sensitive

Can be controlled by WiFi

Controls 3 zones synchronously and separately

Job Name/Date:

Fixture Type Designation:

PHOTOMETRIC DATA

Note: All Photometry is 3000K

Maximum Candela = 31666.7

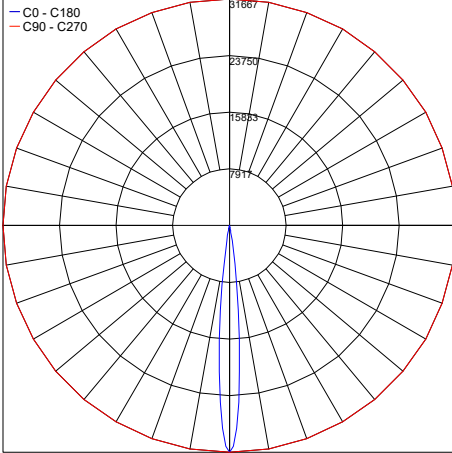

PHOTOMETRIC FILENAME : OLIVER_1.3_S_10_3000K_39W.IES

Maximum Candela = 37157.9

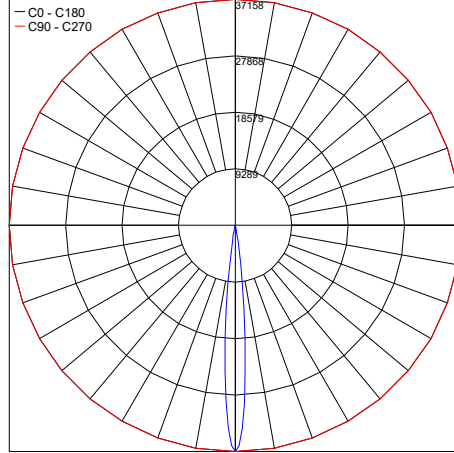

PHOTOMETRIC FILENAME : OLIVER_1.3_S_10_RGBW_39W.IES

Maximum Candela = 5524.1

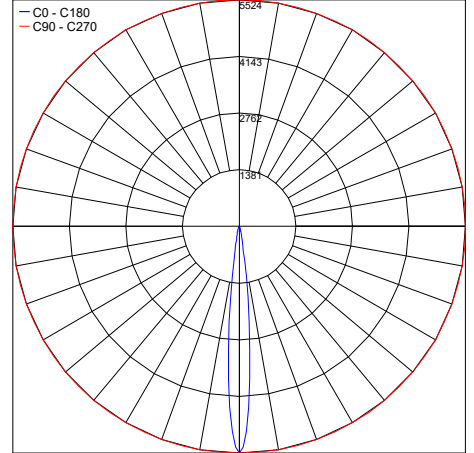

PHOTOMETRIC FILENAME : OLIVER_1.3_X_11X66_3000K_39W.IES

Maximum Candela = 6479.7

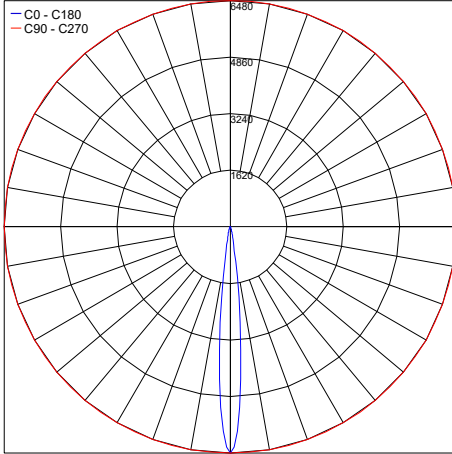

PHOTOMETRIC FILENAME : OLIVER_1.3_X_11X66_RGBW_39W.IES

Maximum Candela = 6509.1

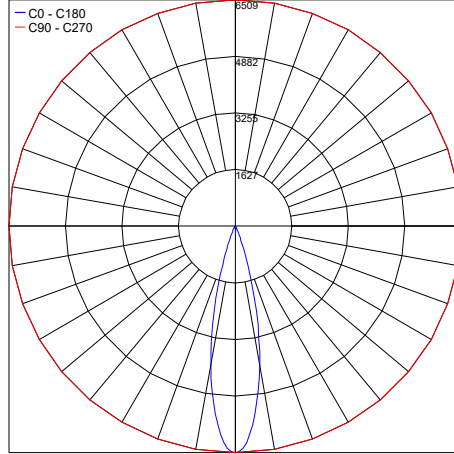

PHOTOMETRIC FILENAME : OLIVER_1.3_M_24_3000K_39W.IES

Maximum Candela = 7635.3

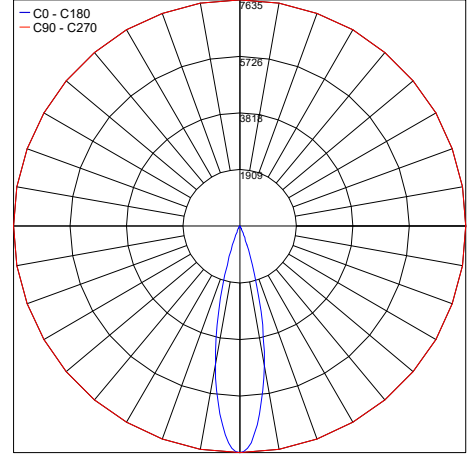

PHOTOMETRIC FILENAME : OLIVER_1.3_M_24_RGBW_39W.IES

Maximum Candela = 2887.1

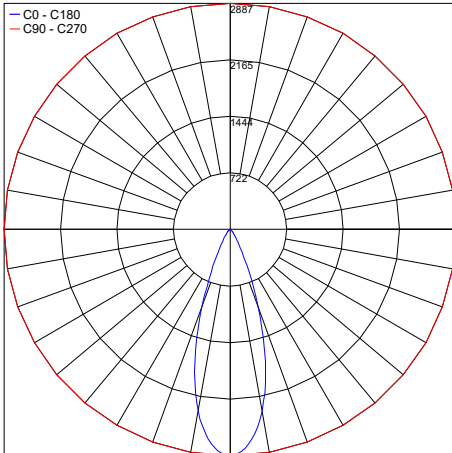

PHOTOMETRIC FILENAME : OLIVER_1.3_L_34_3000K_39W.IES

Maximum Candela = 3387.7

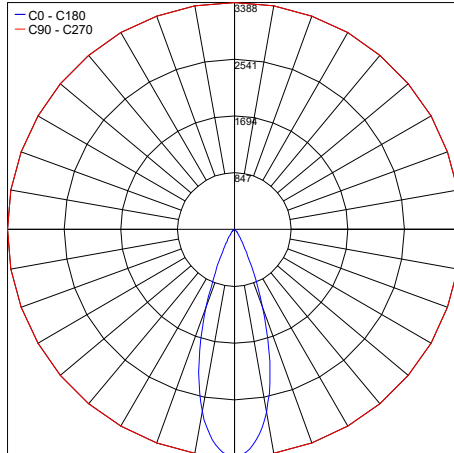

PHOTOMETRIC FILENAME : OLIVER_1.3_L_34_RGBW_39W.IES

Maximum Candela = 31666.7

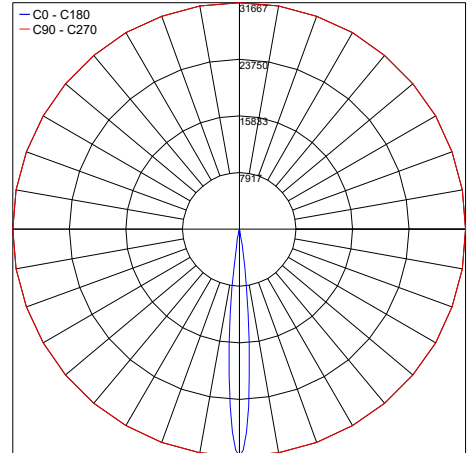

PHOTOMETRIC FILENAME : OLIVER_1.3_S_10_3000K_39W.IES

Job Name/Date:

Fixture Type Designation: