

OLIVER 2.3

Oliver is a family of outdoor floodlights with high performance and a pared-down design for lighting large facades, public spaces and areas. They are available in 3 sizes (Ø7.1", Ø9.1", Ø11.8") with a wide variety of white-light optics, including a very narrow 5° version, as well as an RGBW version which includes a narrow 10° beam. Oliver 2.3 is the Ø9.1" RGBW version.



TECHNICAL DATA

Wattage	55W
Power Supply	Integral 120-277VAC
Dimming	DMX
Construction	Body: Anticorodal Aluminum Lens: 0.31"-Thick Tempered Extra-clear Glass
CCT	RGBW
BUG Rating	B2-U0-G0 (3000K - 55°, 34°) B2-U1-G0 (RGBW - 55°, 3000K - 11°x66°) B3-U0-G0 (RGBW - 34°, 24°, 10°, 30K - 24°, 10°)
Delivered Lumens	5761 lm: (R) 929 lm, (G) 1917 lm, (B) 507 lm, (W) 2408 lm (3000K, 10°)
Efficacy	104.7 lm/W: (R) 16.9 lm/W, (G) 26.3 lm/W, (B) 34.9 lm/W, (W) 43.8 lm/W (3000K, 10°)
Optics	5 Standard (see below)
Finishes	Anthracite, Corten, Gray, White
Fixture Dimensions	Ø9.06" x 13.27" x 5.39"
Fixture Weight	11.7 lbs
LED Source	9 High Intensity Multicolor LEDs
Lumen Maintenance	L80, B10 >60,000hrs (Ta 25°C)
Operating Temp.	-4°F to +113°F
IP Rating	IP66
Impact Rating	IK09

Fixture Dimensions

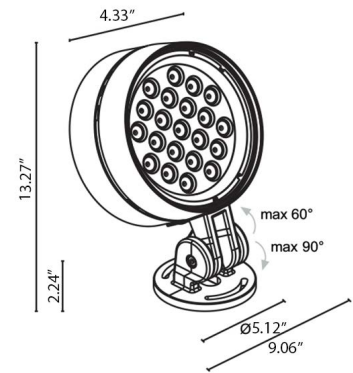

ORDERING INFORMATION

Example: LV2310N40070SH-1. Accessories ordered separately.

LV231	0N4		7			-	1
Model #		Optical Accessory	CCT	Optics	Finish		Cable Length
LV231	0N4	00 - No accessory 01 - Honeycomb Louver <i>NOTE: Honeycomb Louver NOT available for 11°x66° adjustable version.</i>	7 - RGBW	0S - 10° 0M - 24° 0L - 34° 0K - 55° 0X - 11°x66° adjustable <i>NOTE: Honeycomb Louver NOT available for 11°x66° adjustable</i>	H - Anthracite T - Corten F - Gray E - White		1 - 16.40'

Job Name/Date:

Fixture Type Designation:

ACCESSORIES

Anti-Glare

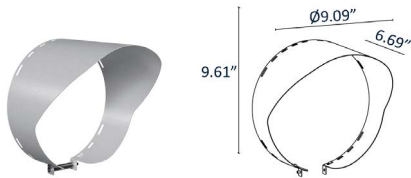

WBA20_

Asymmetrical Snoot

Choose one of the below finishes:

E - White

F - Gray

H - Anthracite

T - Cor-ten

ACCESSORIES

Installation

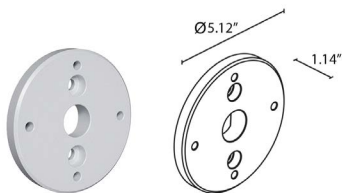

WPA14_

Flange for 3.0" Pole Installation - Ø2.36"

Choose one of the below finishes:

E - White

F - Gray

H - Anthracite

T - Cor-ten

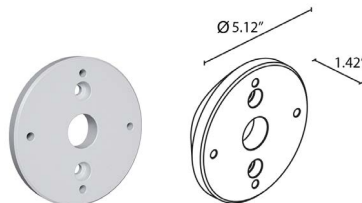

WPA15_

Flange for 4.0" Pole Installation - Ø3.50"

Choose one of the below finishes:

E - White

F - Gray

H - Anthracite

T - Cor-ten

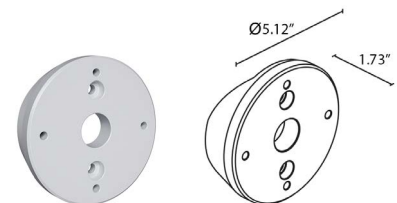

WPA16_

Flange for 5.0" Pole Installation - Ø4.72"

Choose one of the below finishes:

E - White

F - Gray

H - Anthracite

T - Cor-ten

Job Name/Date:

Fixture Type Designation:

PHOTOMETRIC DATA

Note: All Photometry is 3000K

Maximum Candela = 59295.0

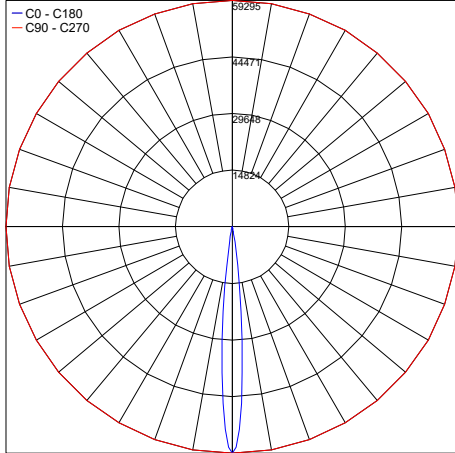

PHOTOMETRIC FILENAME : OLIVER_2.3_S_10_3000K_55W.IES

Maximum Candela = 69563.3

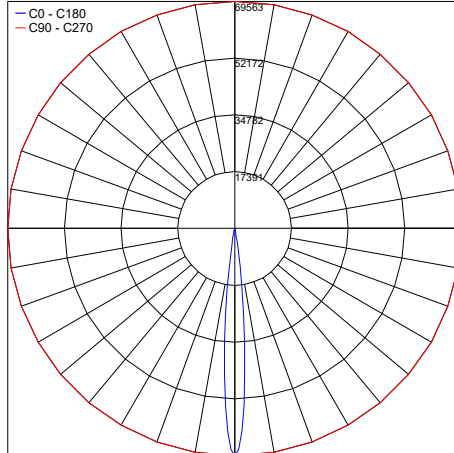

PHOTOMETRIC FILENAME : OLIVER_2.3_S_10_RGBW_55W.IES

Maximum Candela = 10325.7

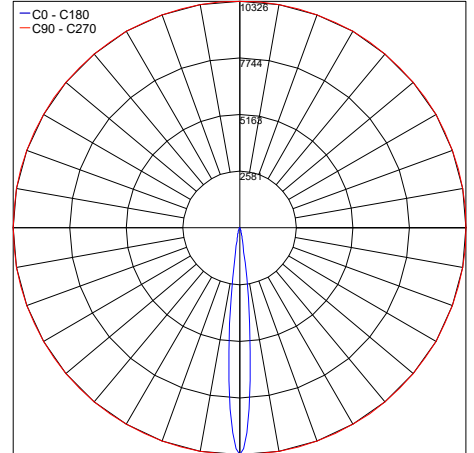

PHOTOMETRIC FILENAME : OLIVER_2.3_X_11X66_3000K_55W.IES

Maximum Candela = 12136.9

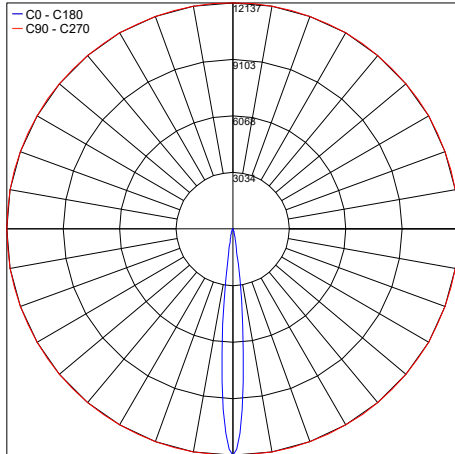

PHOTOMETRIC FILENAME : OLIVER_2.3_X_11X66_RGBW_55W.IES

Maximum Candela = 12171.0

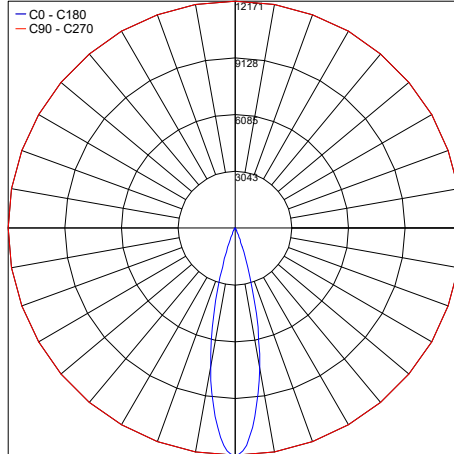

PHOTOMETRIC FILENAME : OLIVER_2.3_M_24_3000K_55W.IES

Maximum Candela = 14294.2

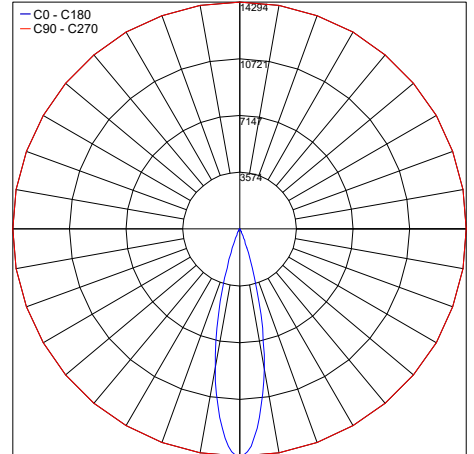

PHOTOMETRIC FILENAME : OLIVER_2.3_M_24_RGBW_55W.IES

Maximum Candela = 5398.1

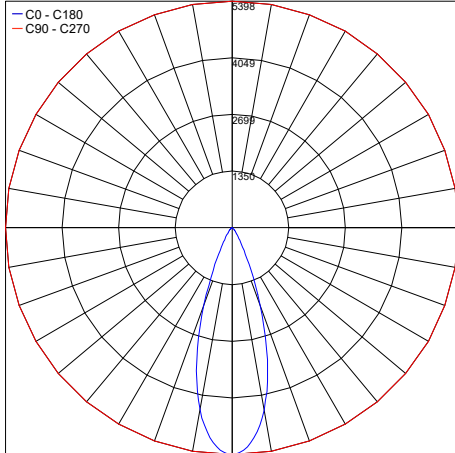

PHOTOMETRIC FILENAME : OLIVER_2.3_L_34_3000K_55W.IES

Maximum Candela = 6342.3

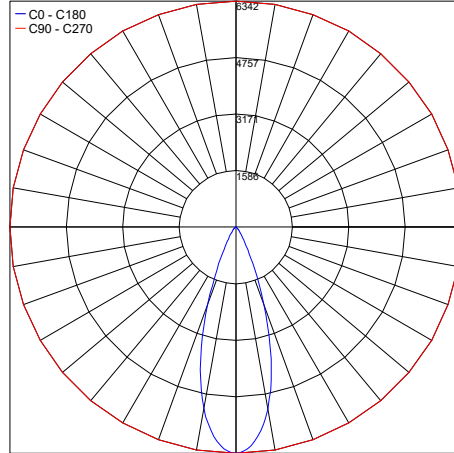

PHOTOMETRIC FILENAME : OLIVER_2.3_L_34_RGBW_55W.IES

Maximum Candela = 2092.3

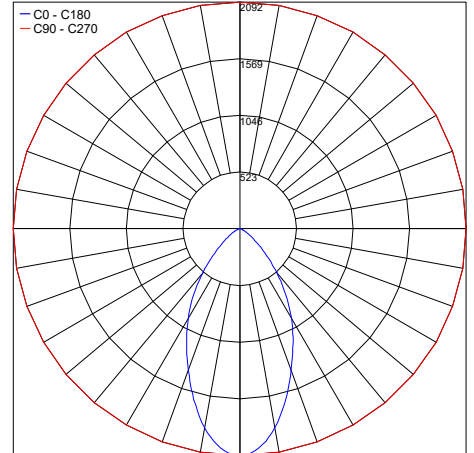

PHOTOMETRIC FILENAME : OLIVER_2.3_K_55_3000K_55W.IES

Job Name/Date:

Fixture Type Designation: