

OLIVER 3.3

Oliver is a family of outdoor floodlights with high performance and a pared-down design for lighting large facades, public spaces and areas. They are available in 3 sizes (Ø7.1", Ø9.1", Ø11.8") with a wide variety of white-light optics, including a very narrow 5° version, as well as an RGBW version which includes a narrow 10° beam. Oliver 3.3 is the Ø11.9" RGBW version.



TECHNICAL DATA

Wattage	93W
Power Supply	Integral 120-277VAC
Dimming	DMX
Construction	Body: Anticorodal Aluminum Lens: 0.31"-Thick Tempered Extra-clear Glass
CCT	RGBW
BUG Rating	B3-U0-G0 (3000K, RGBW - 34°, 24°, 10° B3-U1-G0 (3000K - 11°x66°, RGBW - 55°, 11°x66° B2-U1-G0 (3000K - 55°)
Delivered Lumens	8575 lm: (R) 1384 lm, (G) 2853 lm, (B) 755 lm, (W) 3583 lm (3000K, 10°)
Efficacy	92.2 lm/W: (R) 14.9 lm/W, (G) 30.7 lm/W, (B) 8.1 lm/W, (W) 38.5 lm/W (3000K, 10°)
Optics	5 Standard (see below)
Finishes	Anthracite, Corten, Gray, White, Custom RAL (4 Stage Marine Grade Finish)
Fixture Dimensions	Ø11.85" x 16.06" x 5.39"
Fixture Weight	19.40 lbs
LED Source	16 High Intensity Multicolor LEDs
Lumen Maintenance	L80, B10 >60,000hrs (Ta 25°C)
Operating Temp.	-4°F to +113°F
IP Rating	IP66
Impact Rating	IK09

Fixture Dimensions

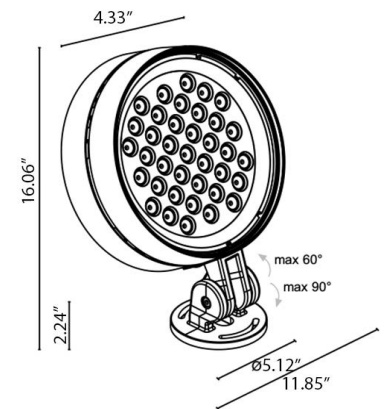

ORDERING INFORMATION

Example: LV3310N40070SH-1. Accessories ordered separately.

LV331	0N4		7			-	1
Model No.		Optical Accessory	CCT	Optics	Finish		Cable Length
LV331	0N4	00 - No accessory 01 - Honeycomb Louver <i>NOTE: Honeycomb Louver NOT available for 11°x66° adjustable version.</i>	7 - RGBW	0S - 10° 0M - 24° 0L - 34° 0K - 55° 0X - 11°x66° adjustable <i>NOTE: Honeycomb Louver NOT available for 11°x66° adjustable</i>	H - Anthracite T - Corten F - Gray E - White C - Custom RAL (Consult factory for "C")		1 - 16.40'

Job Name/Date:

Fixture Type Designation:

ACCESSORIES

Anti-Glare

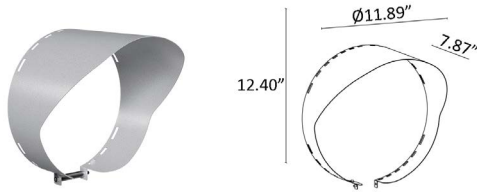

WBA21_

Asymmetrical Snoot

Choose one of the below finishes:

- E - White
- F - Gray
- H - Anthracite
- T - Cor-ten

ACCESSORIES

Installation

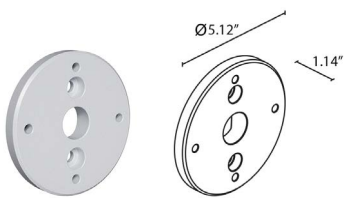

WPA14_

Flange for 3.0" Pole Installation - **Ø2.36"**

Choose one of the below finishes:

- E - White
- F - Gray
- H - Anthracite
- T - Cor-ten

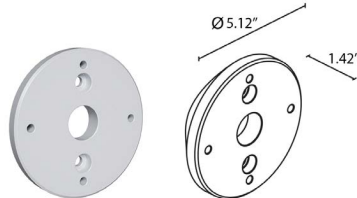

WPA15_

Flange for 4.0" Pole Installation - **Ø3.50"**

Choose one of the below finishes:

- E - White
- F - Gray
- H - Anthracite
- T - Cor-ten

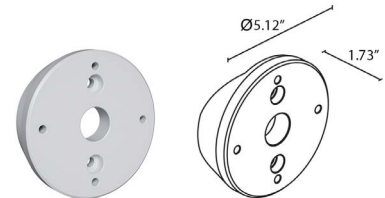

WPA16_

Flange for 5.0" Pole Installation - **Ø4.72"**

Choose one of the below finishes:

- E - White
- F - Gray
- H - Anthracite
- T - Cor-ten

ACCESSORIES

Controllers (RGBW)

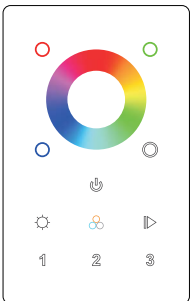

PPWD00570 - RGBW DMX512+Wifi Controller

Touch Sensitive

Can be controlled by WiFi

Controls 3 zones synchronously and separately

Job Name/Date:

Fixture Type Designation:

PHOTOMETRIC DATA

Note: All Photometry is 3000K

Maximum Candela = 88228.4

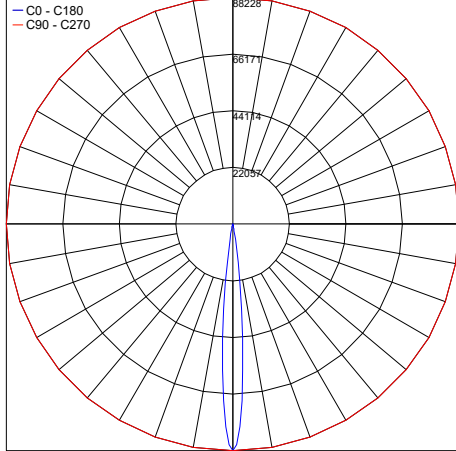

PHOTOMETRIC FILENAME : OLIVER_3.3_S_10_3000K_93W.IES

Maximum Candela = 103520

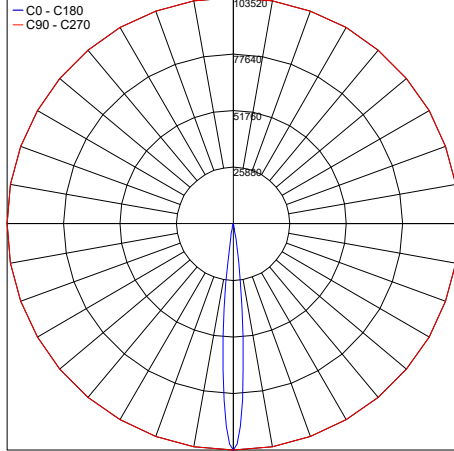

PHOTOMETRIC FILENAME : OLIVER_3.3_S_10_RGBW_93W.IES

Maximum Candela = 15407.7

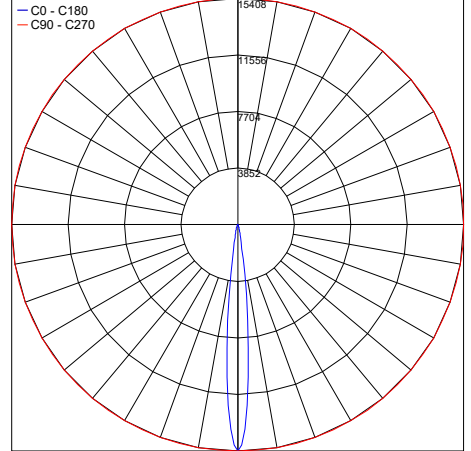

PHOTOMETRIC FILENAME : OLIVER_3.3_X_11X66_3000K_93W.IES

Maximum Candela = 18060.4

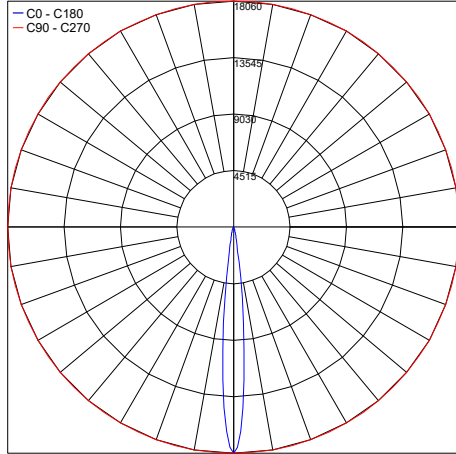

PHOTOMETRIC FILENAME : OLIVER_3.3_X_11X66_RGBW_93W.IES

Maximum Candela = 18158.3

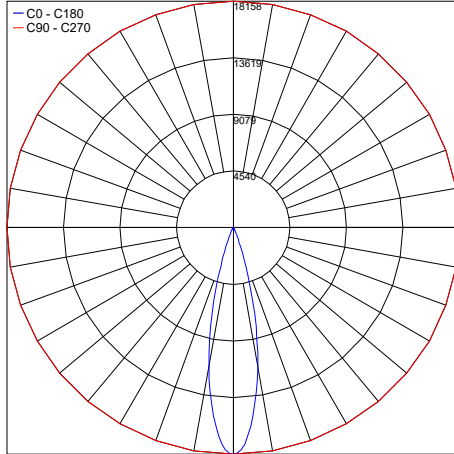

PHOTOMETRIC FILENAME : OLIVER_3.3_M_24_3000K_93W.IES

Maximum Candela = 21273.4

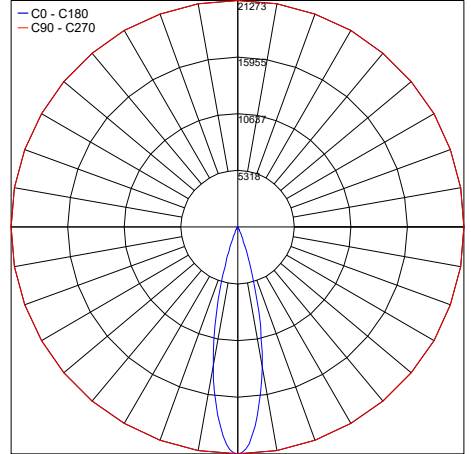

PHOTOMETRIC FILENAME : OLIVER_3.3_M_24_RGBW_93W.IES

Maximum Candela = 8054.3

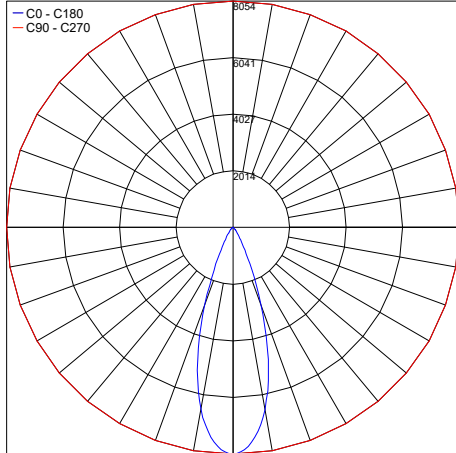

PHOTOMETRIC FILENAME : OLIVER_3.3_L_34_3000K_93W.IES

Maximum Candela = 9436.9

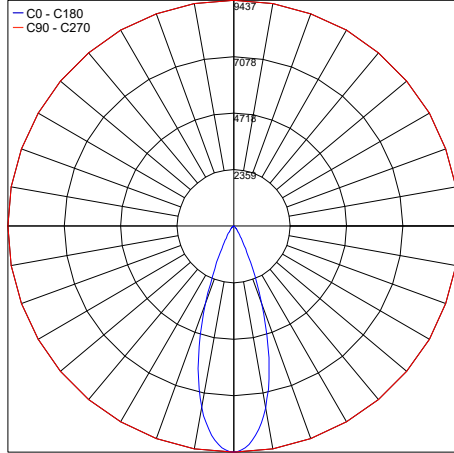

PHOTOMETRIC FILENAME : OLIVER_3.3_L_34_RGBW_93W.IES

Maximum Candela = 3121.4

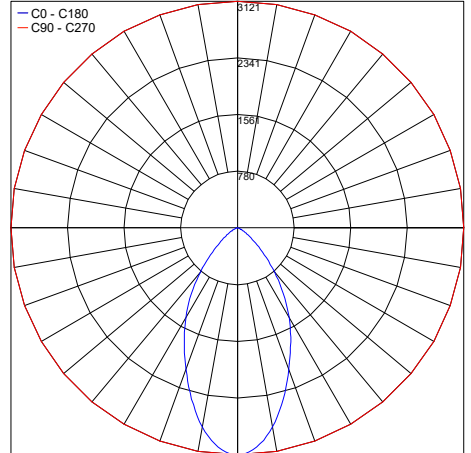

PHOTOMETRIC FILENAME : OLIVER_3.3_K_55_3000K_93W.IES

Job Name/Date:

Fixture Type Designation: