

CUPOLA 1, 2, 3 & 4

4W, Remote 24VDC

designplan®

installation instructions



INSTRUCTIONS PERTAINING TO RISK OF FIRE OR INJURY TO PERSONS. READ ALL INSTRUCTIONS. IMPORTANT SAFETY INSTRUCTIONS. SAVE THESE INSTRUCTIONS.

DANGER - RISK OF SHOCK - DISCONNECT POWER BEFORE INSTALLATION! Please read all instructions before installation.

- Keep these instructions for future reference.
- Must be installed by a qualified electrician in accordance with national and local standards. Designplan is not responsible for fixtures installed without regard to these standards.
- The main power connection must be in accordance with local electrical codes.
- Unauthorized alterations or tampering of product voids warranty.
- Suitable for OUTDOOR applications.

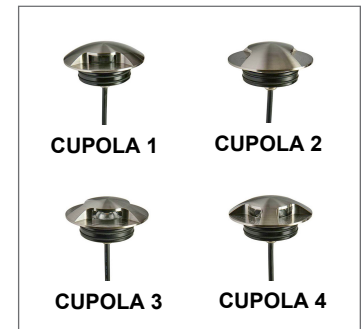

 **IP67 IK10**

Electrical Connections:

- LED lights must be **connected in parallel** respecting polarities.
- **CHOOSE POWER SUPPLY ACCORDINGLY.** Please consider the voltage through which fixtures are fed as well as the max power consumption.
- **Connect power only if all the fixtures are connected.**
- The power supplies **MUST** be installed in aerated rooms, far from heat sources. Overloading or lack of air circulation will not permit natural dissipation.
- Use only Class 2 type electronic power supply.
- Never use switches on secondary circuit.

ATTENTION: For In-Grade - It is the contractor's responsibility to seal the conduit with "Great Stuff" aerosol seal that prevents water and moisture penetration for ultimate protection. Contractor **MUST** use gel-filled wire nuts.

Maintenance

Scheduled maintenance must be carried out once a year on all lighting devices, regardless of appliance class and type of use. It must include the following operations:

- Periodically clean fixtures to remove dirt from gratings and screw heads.
- Check tightness of screws on various parts of the device.
- Check that all cable glands and cables are intact and tight. Check that the glass or plastic lens is intact, and replace it if broken or damaged.
- The internal components such as the ballast, driver, washers and screws must not show clear signs of oxidation or rust. Clear traces of rust and oxidation will indicate the presence of water inside the device.
- In the case of damage, the components must be replaced by original components or spare parts.

CUPOLA 1, 2, 3 & 4

4W, Remote 24VDC

designplan®

installation instructions

FIXTURE DIMENSION:

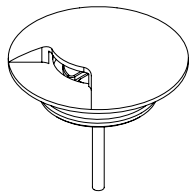
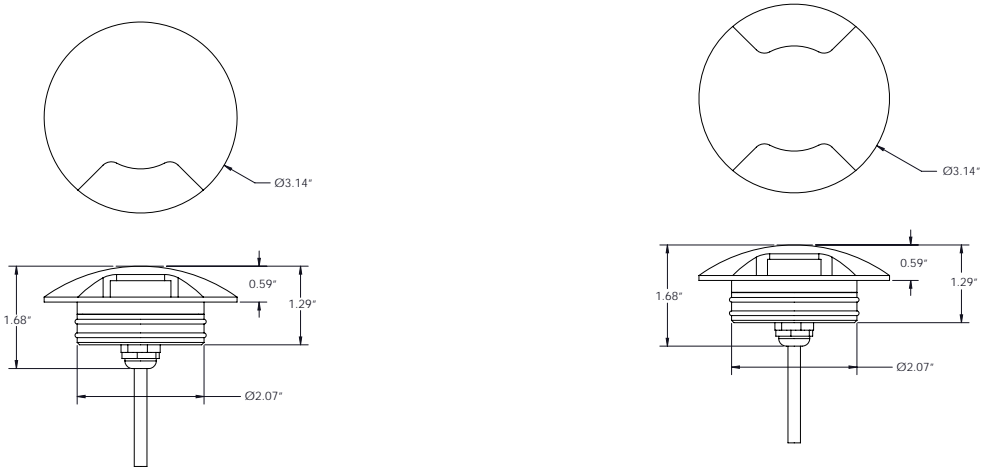

CUPOLA 1

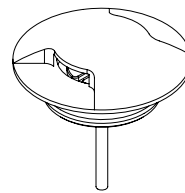

CUPOLA 2

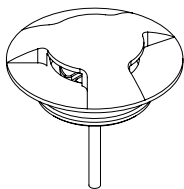
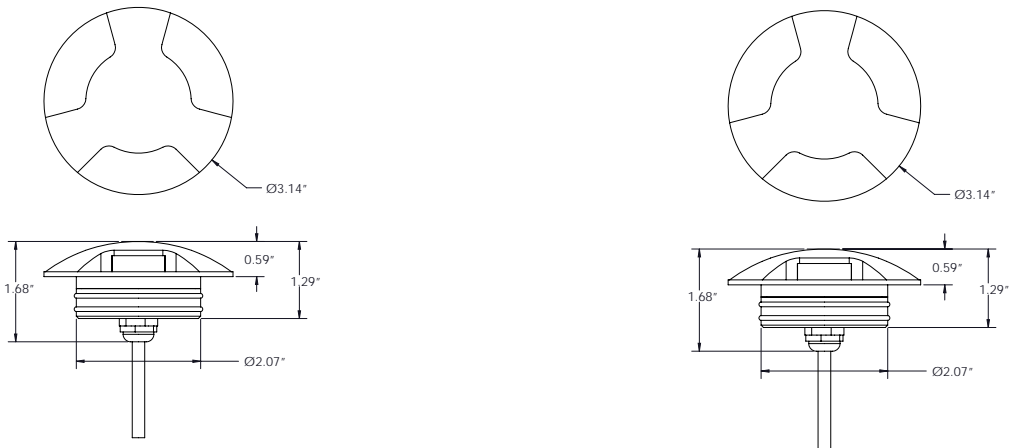

CUPOLA 3

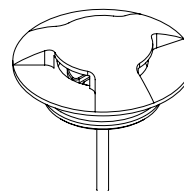

CUPOLA 4

CUPOLA 1, 2, 3 & 4

4W, Remote 24VDC

designplan®

installation instructions

FIXTURE INSTALLATION

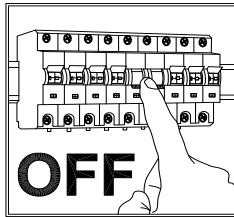

- It is the contractor's responsibility to caulk around all the edges between the fixture and the mounting surface, to satisfy wet label requirements.
- It is the contractor's responsibility to install Remote Driver in a suitable electrical enclosure.

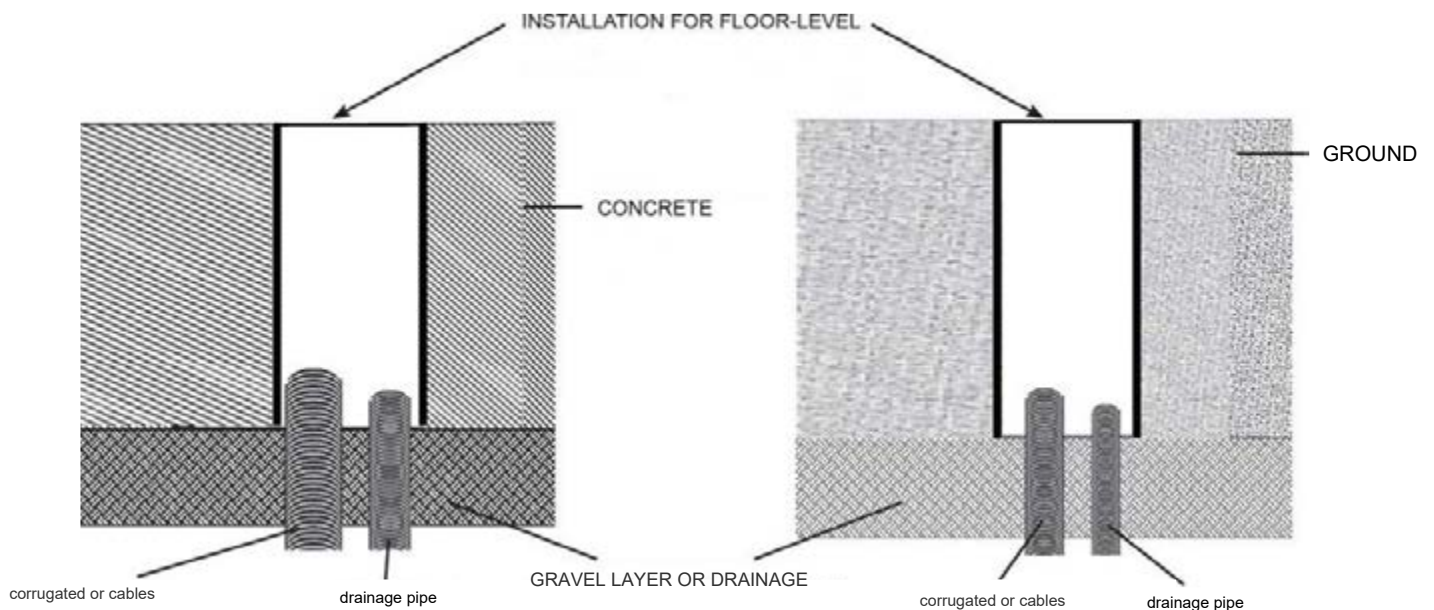

1.

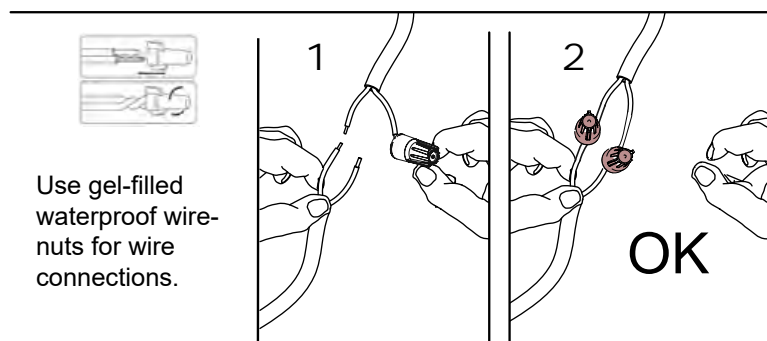

CUPOLA 1, 2, 3 & 4

4W, Remote 24VDC

designplan®

installation instructions

2.



3.

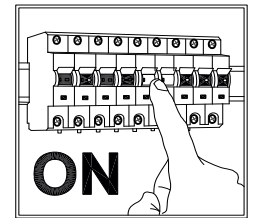

FIXTURE INSTALLED IN GROUND

