

Elite
Line

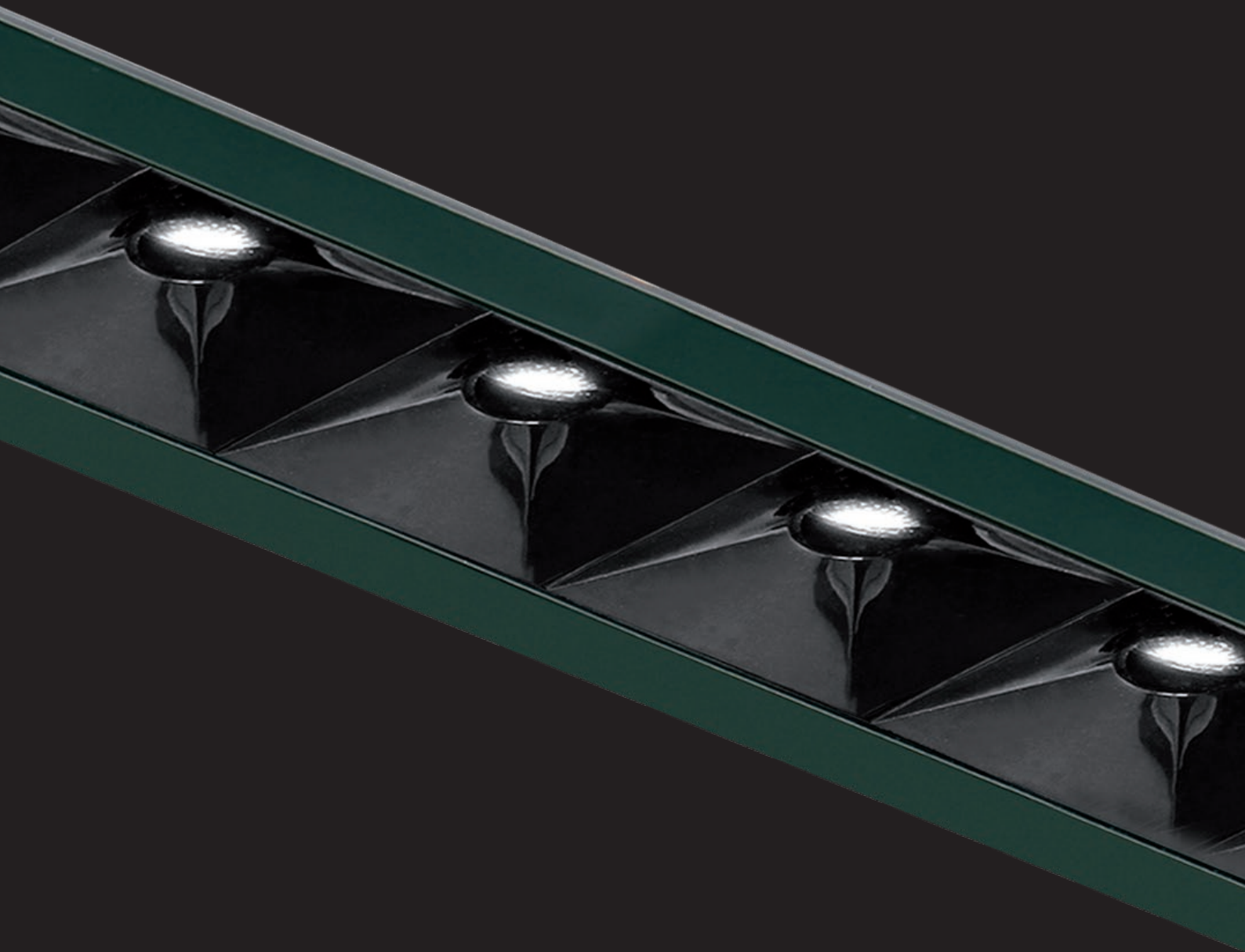

designplan® 

Organic
LIGHTING

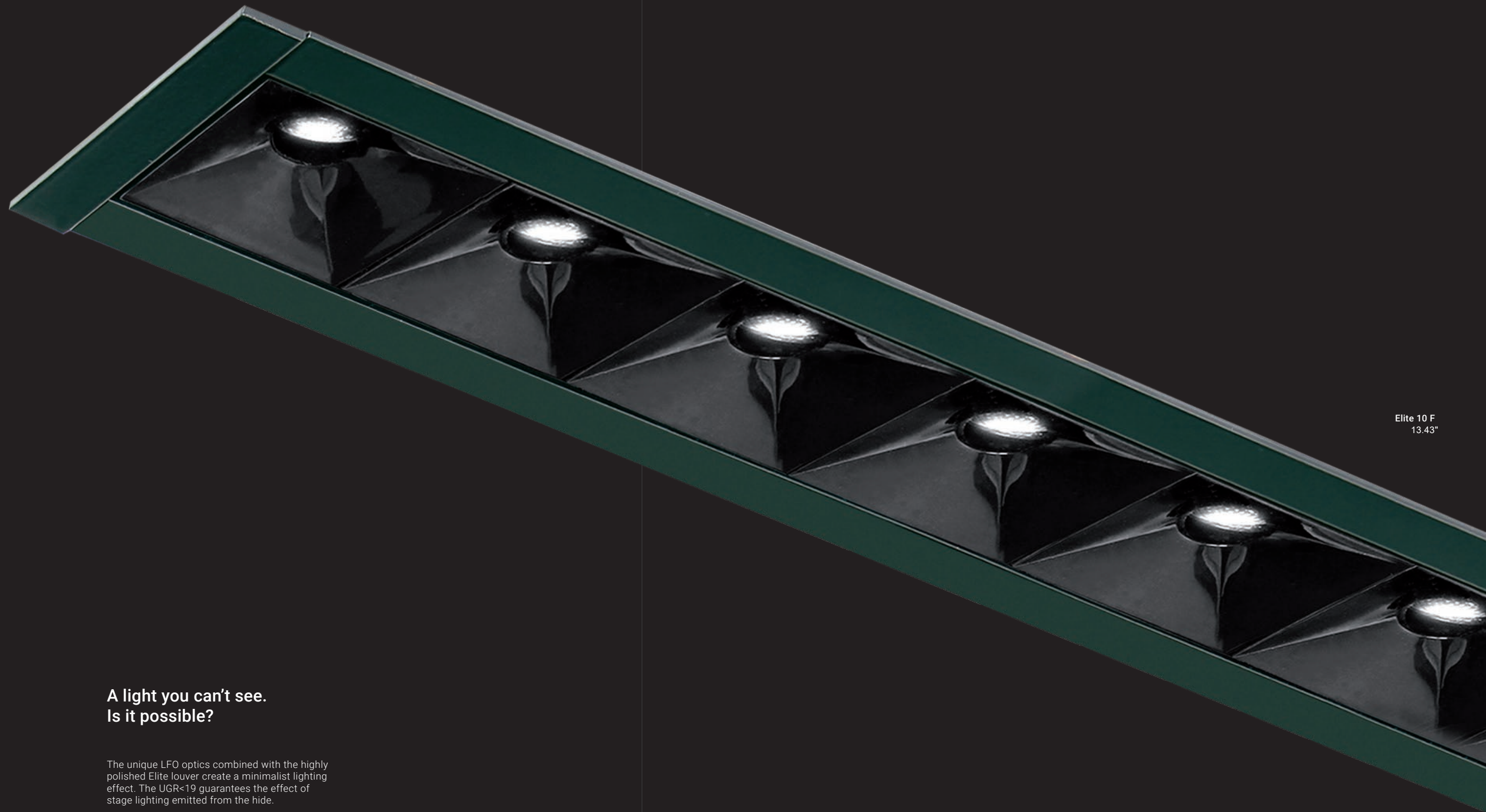

Elite 10 F
13.43"

**A light you can't see.
Is it possible?**

The unique LFO optics combined with the highly polished Elite louver create a minimalist lighting effect. The UGR<19 guarantees the effect of stage lighting emitted from the hide.



Elite C
Ceiling

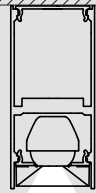

Elite S
Suspended

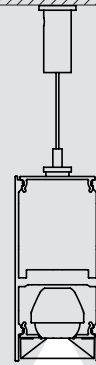

Elite F
Frame

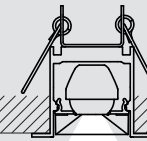

Elite T
trimless

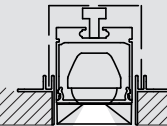

Four installation variants.

Thanks to the various mounting options, Elite luminaires blend in any interior design, giving it a theatrical character.



LED module

LED module on an aluminum base designed specifically by ILUM.

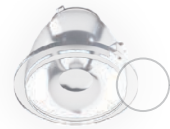

Bartenbach LFO lens

Bartenbach LFO lens - specially designed optics form the light in such a way that it is possible to hide the light source and shine through a small hole. It minimizes the glare effect and provides the functionality of a standard lens.



The lens cover

The lens cover made of silicone rubber modulates the light beam in a way to emit as much as possible light outside.

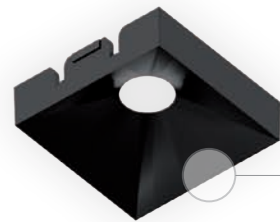

Anti-glare louver

Highly polished louver ensures elegant design and minimal glare.

LFO technology

The LFO technology, developed by scientists from the Bartenbach laboratory in Austria emits light through 0.35 inch hole invisibly to the eye. The combination of this phenomenon with the highly polished Elite louver designed by the ILUM team ensures that the viewer cannot see where the light is coming from and the emitted light is user-friendly. The final effect provides a unique comfort of staying in such illuminated room.

Healthy light

Thanks to the low UGR index <19, the glare effect is reduced and exclusive lighting quality and absolute visual comfort are achieved.

UGR <19
No Glare

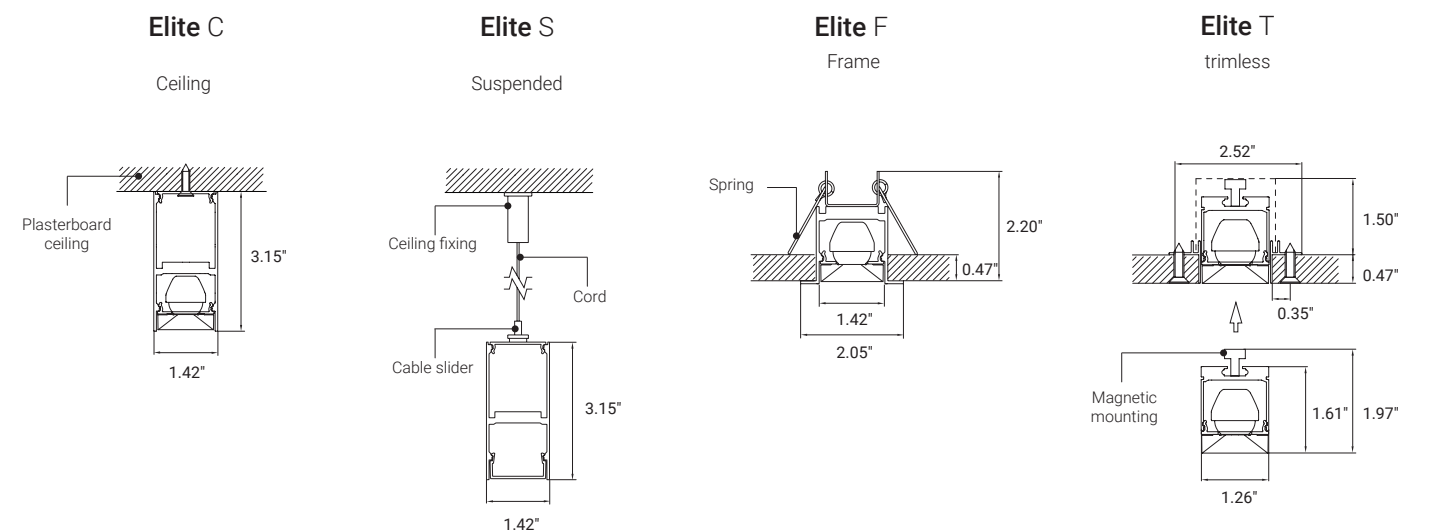



Elite

C

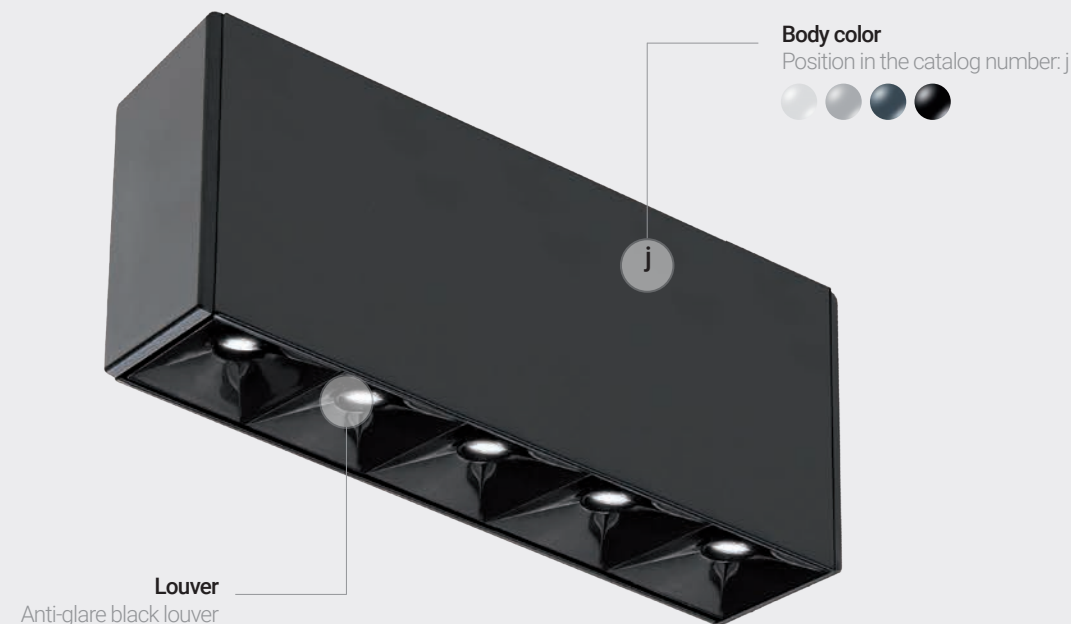

Features

LED	3000K 4000K	CRI>80	SDCM ≤ 3	50,000h L80 B10	IP20	ON/OFF DALI	120-277V 50-60HZ	
-----	----------------	--------	----------	--------------------	------	----------------	---------------------	--

Colors:

Mounting: ceiling built-on.

Light source: PCB LED, 3000K / 4000K, CRI> 80, MacAdam ≤ 3, 50,000h L80B10.

Luminaire power: high output (HO).

Optic: lens 30°/60° with anti-glare black louver.

Light distribution: direct.

Housing: powder coated extruded aluminum profile.

Control: ON / OFF or DALI.

IP protection: IP20

Elite C DIRECT



Version with LED CC HO (High Output)

Type	Length	Power	Luminaire flux *		Code
			lens 30° UGR<19	lens 60° UGR<19	
Elite 1 C	1.54"	2.2 W	195 lm	200 lm	5.3001.01C1.0g7i.j0
Elite 2 C	2.80"	4.5 W	390 lm	400 lm	5.3001.02C1.0g7i.j0
Elite 3 C	4.06"	6.7 W	585 lm	600 lm	5.3001.03C1.0g7i.j0
Elite 5 C	6.57"	11.2 W	975 lm	1000 lm	5.3001.05C1.0g7i.j0
Elite 8 C	10.35"	17.9 W	1560 lm	1600 lm	5.3001.08C1.fg7i.j0
Elite 10 C	12.87"	22.4 W	1950 lm	2000 lm	5.3001.10C1.fg7i.j0
Elite 12 C	15.39"	26.9 W	2340 lm	2400 lm	5.3001.12C1.fg7i.j0

⚠ For Elite 1, 2, 3, 5 driver not included, must be ordered separately.

*Fixture lumen output data refer to 4000K.

Elite Accessories

Type	Dimensions	Code
Driver cover	4.72" x 1.77"	5.3020.0100.0000.40

⚠ Driver cover recommended for ELITE 1, 2, 3 and 5 (service revision).

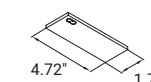

Elite 1 C



1.54"

Elite 2 C



2.80"

Elite 3 C



4.06"

Elite 5 C

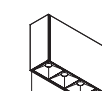

6.57"

Elite 8 C

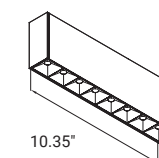

10.35"

Elite 10 C

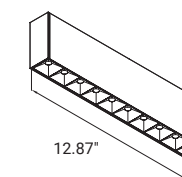

12.87"

Elite 12 C

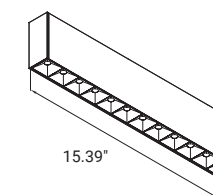

15.39"

Driver	f	LED color	g	Beam angle	i	Finishing	j
ON/OFF	1	830	2	30°	M	white (RAL9016)	4
DALI	2	840	3	60°	W	black (RAL9005)	5
						fog (RAL7038)	G
						graphite (RAL7024)	H



Elite

S

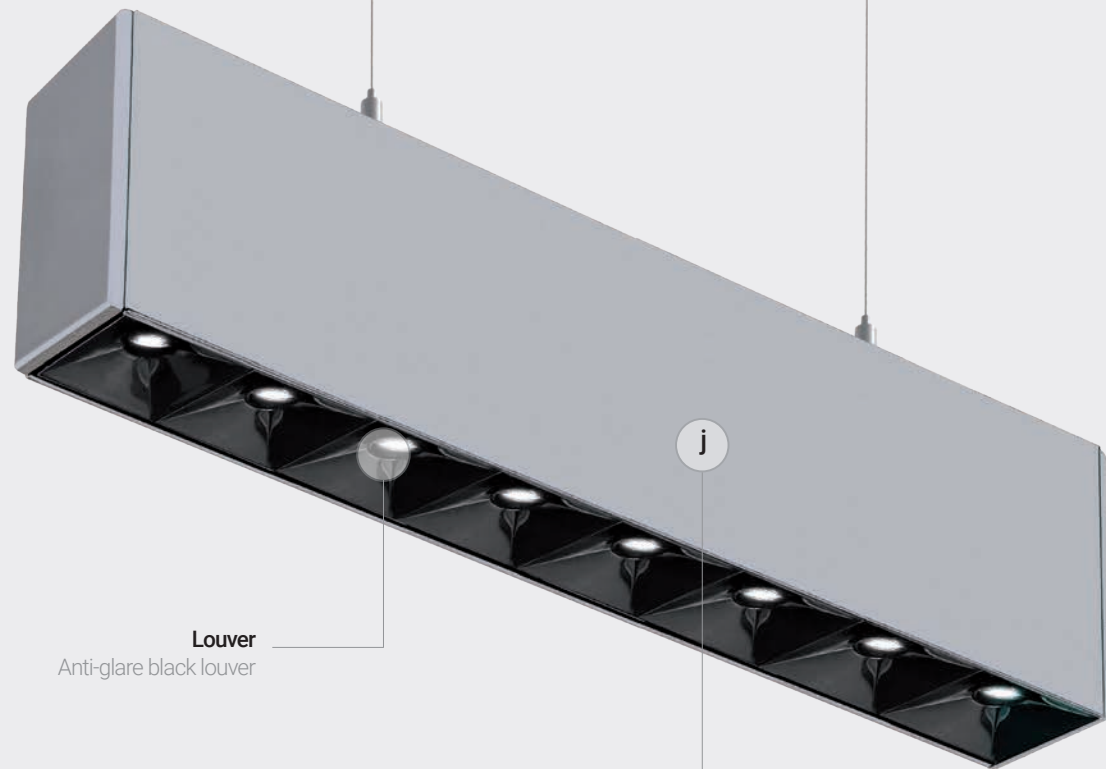

Louver
Anti-glare black louver

Body color
Position in the catalog number: j

Features

LED | 3000K / 4000K | CRI>80 | SDCM ≤ 3 | 50,000h L80 B10 | IP20 | ON/OFF DALI | 120-277V 50-60HZ

Colors:

Mounting: suspended.
Light source: PCB LED, 3000K / 4000K, CRI> 80, MacAdam ≤ 3, 50,000h L80B10.
Luminaire power: high output (HO).
Optic: lens 30°/60° with anti-glare black louver.
Light distribution: direct.
Housing: powder coated extruded aluminum profile.
Control: ON / OFF or DALI.
IP protection: IP20

Elite S DIRECT



Version with LED CC HO (High Output)

Type	Length	Power	Luminaire flux *		Code
			lens 30° UGR<19	lens 60° UGR<19	
Elite 1 S	1.54"	2.2 W	195 lm	200 lm	5.3002.01D1.0g7i.j0
Elite 2 S	2.80"	4.5 W	390 lm	400 lm	5.3002.02D1.0g7i.j0
Elite 3 S	4.06"	6.7 W	585 lm	600 lm	5.3002.03D1.0g7i.j0
Elite 5 S	6.57"	11.2 W	975 lm	1000 lm	5.3002.05D1.0g7i.j0
Elite 8 S	10.35"	17.9 W	1560 lm	1600 lm	5.3002.08D1.fg7i.j0
Elite 10 S	12.87"	22.4 W	1950 lm	2000 lm	5.3002.10D1.fg7i.j0
Elite 12 S	15.39"	26.9 W	2340 lm	2400 lm	5.3002.12D1.fg7i.j0

▲ For Elite 1, 2, 3, 5 driver not included, must be ordered separately.

*Fixture lumen output data refer to 4000K.

Drivers

Type	Max. numbers of luminaires supplied from one driver								Code
	Elites:								
	1 S	2 S	3 S	5 S	8 S	10 S	12 S		
Driver 20W 250-700mA max. 59V ON-OFF	9 pcs.	4 pcs.	3 pcs.	1 pcs.	-	-	-	5.3011.0101.1000.00	
Driver 45W 500-1400mA max. 50V ON-OFF	12 pcs.	6 pcs.	4 pcs.	2 pcs.	-	-	-	5.3012.0201.1000.00	
Driver 20W 250-700mA max. 55V DALI	9 pcs.	4 pcs.	3 pcs.	1 pcs.	-	-	-	5.3015.0301.2000.00	
Driver 45W 500-1400mA max. 50V DALI	12 pcs.	6 pcs.	4 pcs.	2 pcs.	-	-	-	5.3016.0401.2000.00	

Elite Accessories

Type	Dimensions	Code
Driver cover	4.72" x 1.77"	5.3020.0100.0000.40

▲ Driver cover recommended for ELITE 1, 2, 3 and 5 (service revision).

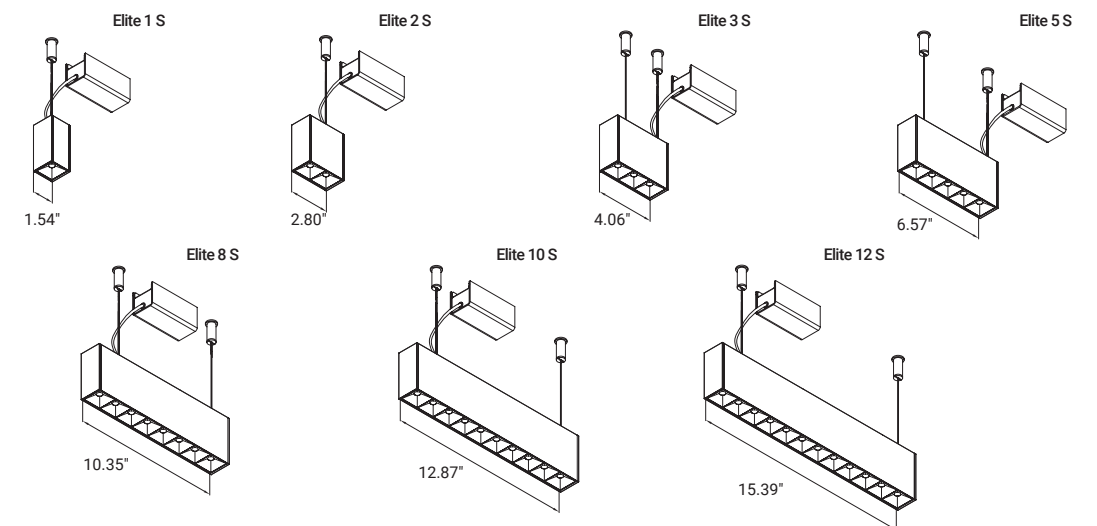
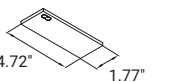

Driver	f	LED color	g	Beam angle	i	Finishing	j
ON/OFF	1	830	2	30°	M	white (RAL9016)	4
DALI	2	840	3	60°	W	black (RAL9005)	5
						fog (RAL7038)	G
						graphite (RAL7024)	H





Elite

F

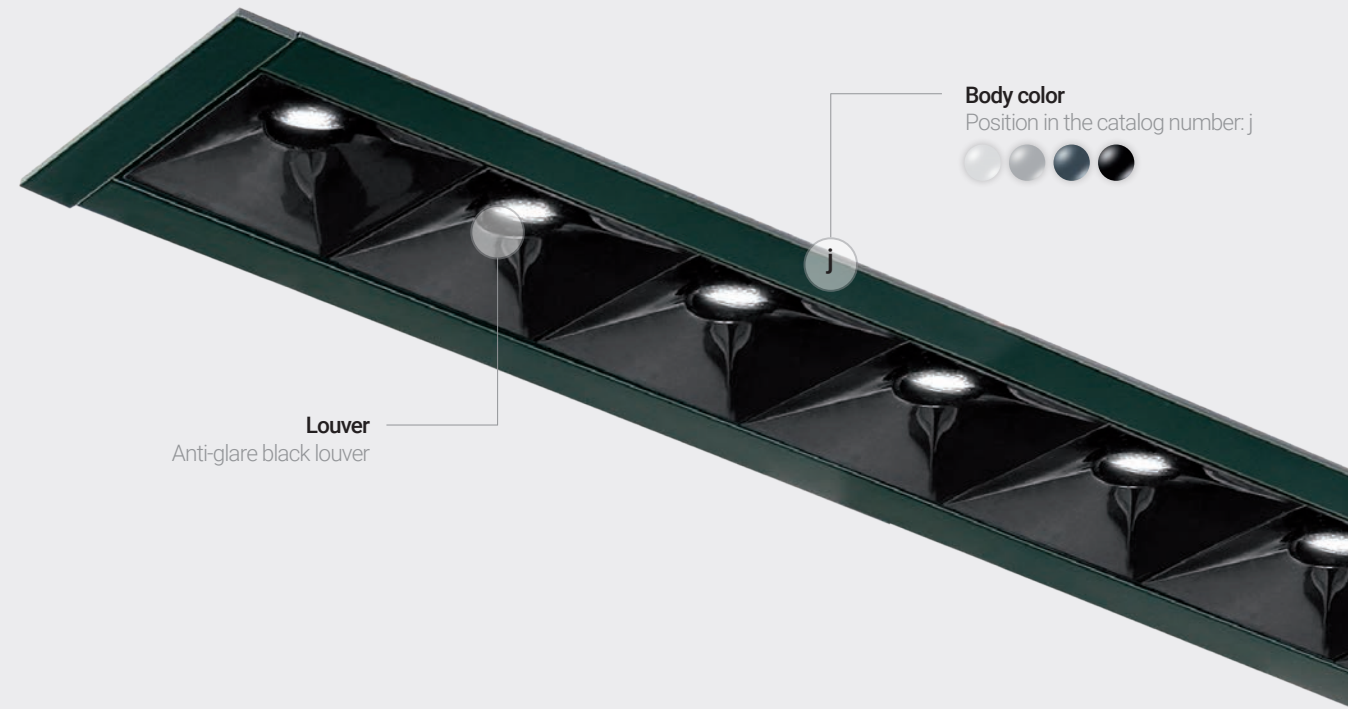

Body color
Position in the catalog number: j



Louvers
Anti-glare black louvers

Features

LED	3000K 4000K	CRI>80	SDCM ≤ 3	50,000h L80 B10	IP20	ON/OFF DALI	120-277V 50-60HZ	
-----	----------------	--------	----------	--------------------	------	----------------	---------------------	--

Colors:

Mounting: recessed with a frame.

Light source: PCB LED, 3000K / 4000K, CRI> 80, MacAdam ≤ 3, 50,000h L80B10.

Luminaire power: high output (HO).

Optic: lens 30°/60° with anti-glare black louver.

Light distribution: direct.

Housing: powder coated extruded aluminum profile.

Control: ON / OFF or DALI.

IP protection: IP20

Elite F DIRECT



Version with
LED CC HO
(High Output)

Type	Length	Power	Luminaire flux *		Code
			lens 30° UGR<19	lens 60° UGR<19	
Elite 1 F	2.09"	2.2 W	195 lm	200 lm	5.3003.01F1.0g7i.j0
Elite 2 F	3.35"	4.5 W	390 lm	400 lm	5.3003.02F1.0g7i.j0
Elite 3 F	4.61"	6.7 W	585 lm	600 lm	5.3003.03F1.0g7i.j0
Elite 5 F	7.13"	11.2 W	975 lm	1000 lm	5.3003.05F1.0g7i.j0
Elite 8 F	10.91"	17.9 W	1560 lm	1600 lm	5.3003.08F1.0g7i.j0
Elite 10 F	13.43"	22.4 W	1950 lm	2000 lm	5.3003.10F1.0g7i.j0
Elite 12 F	15.94"	26.9 W	2340 lm	2400 lm	5.3003.12F1.0g7i.j0

⚠ Driver not included, must be ordered separately.

*Fixture lumen output data refer to 4000K.

L - 0.39" x 1.57" | Hmin = 3.94"

Drivers

Type	Max. numbers of luminaires supplied from one driver							Code
	1 F	2 F	3 F	5 F	8 F	10 F	12 F	
Driver 20W 250-700mA max. 59V ON-OFF	9 pcs.	4 pcs.	3 pcs.	1 pcs.	1 pcs.	-	-	5.3011.0101.1000.00
Driver 45W 500-1400mA max. 50V ON-OFF	12 pcs.	6 pcs.	4 pcs.	2 pcs.	1 pcs.	1 pcs.	1 pcs.	5.3012.0201.1000.00
Driver 20W 250-700mA max. 55V DALI	9 pcs.	4 pcs.	3 pcs.	1 pcs.	1 pcs.	-	-	5.3015.0301.2000.00
Driver 45W 500-1400mA max. 50V DALI	12 pcs.	6 pcs.	4 pcs.	2 pcs.	1 pcs.	1 pcs.	1 pcs.	5.3016.0401.2000.00

Elite Accessories

Type	Dimensions	Code
Driver cover	4.72" x 1.77"	5.3020.0100.0000.40

⚠ Driver cover recommended for ELITE 1, 2 and 3 (service revision).

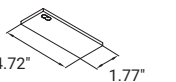

Elite 1 F



2.09"

Elite 2 F



3.35"

Elite 3 F



4.61"

Elite 5 F

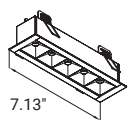

7.13"

Elite 8 F

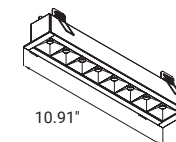

10.91"

Elite 10 F

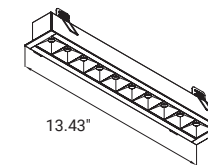

13.43"

Elite 12 F

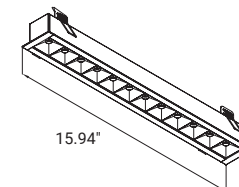

15.94"

LED color	g	Beam angle	i	Finishing	j
830	2	30°	M	white (RAL9016)	4
840	3	60°	W	black (RAL9005)	5
				fog (RAL7038)	G
				graphite (RAL7024)	H





Elite

T

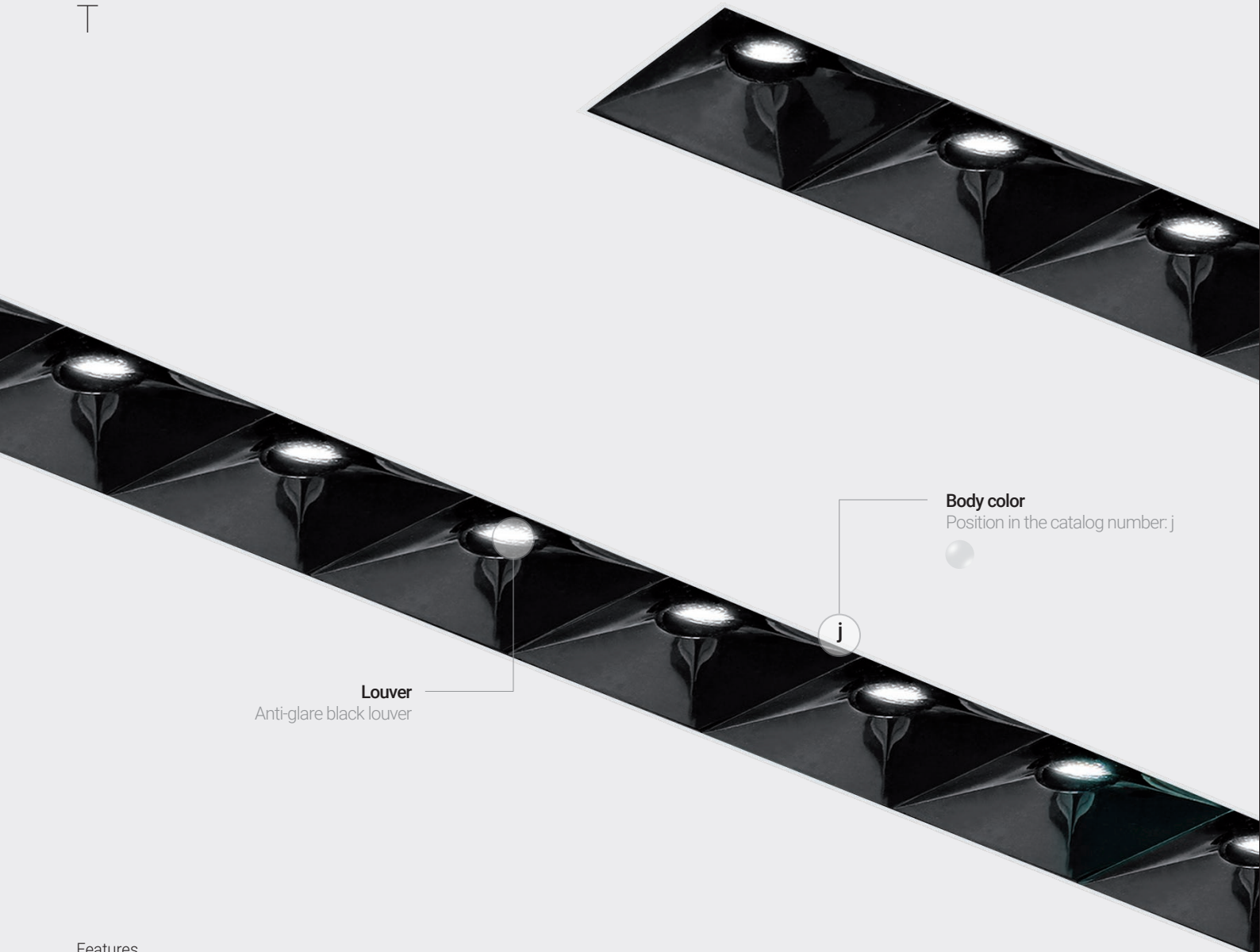

Louver
Anti-glare black louver

Body color
Position in the catalog number: j

j

Features

LED | 3000K / 4000K | CRI>80 | SDCM ≤ 3 | 50,000h L80 B10 | IP20 | ON/OFF DALI | 120-277V 50-60HZ | 

Colors: 

- Mounting:** Recessed trimless.
- Light source:** PCB LED, 3000K / 4000K, CRI> 80, MacAdam ≤ 3, 50,000h L80B10.
- Luminaire power:** high output (HO).
- Optic:** lens 30°/60° with anti-glare black louver.
- Light distribution:** direct.
- Housing:** powder coated extruded aluminum profile.
- Control:** ON / OFF or DALI.
- IP protection:** IP20

Elite T DIRECT



Version with LED CC HO (High Output)

Type	Length	Power	Luminaire flux *		Code
			lens 30° UGR<19	lens 60° UGR<19	
Elite 1 T	1.42"	2.2 W	195 lm	200 lm	5.3004.01T1.0g7i.40
Elite 2 T	2.68"	4.5 W	390 lm	400 lm	5.3004.02T1.0g7i.40
Elite 3 T	3.94"	6.7 W	585 lm	600 lm	5.3004.03T1.0g7i.40
Elite 5 T	6.46"	11.2 W	975 lm	1000 lm	5.3004.05T1.0g7i.40
Elite 8 T	10.24"	17.9 W	1560 lm	1600 lm	5.3004.08T1.0g7i.40
Elite 10 T	12.76"	22.4 W	1950 lm	2000 lm	5.3004.10T1.0g7i.40
Elite 12 T	15.24"	26.9 W	2340 lm	2400 lm	5.3004.12T1.0g7i.40

⚠ Driver not included, must be ordered separately.

 L + 0.08" x 1.46" | Hmin = 3.94"

* Fixture lumen output data refer to 4000K.

Drivers

Type	Max. numbers of luminaires supplied from one driver							Code
	1 T	2 T	3 T	5 T	8 T	10 T	12 T	
Driver 20W 250-700mA max. 59V ON-OFF	9 pcs.	4 pcs.	3 pcs.	1 pcs.	1 pcs.	-	-	5.3011.0101.1000.00
Driver 45W 500-1400mA max. 50V ON-OFF	12 pcs.	6 pcs.	4 pcs.	2 pcs.	1 pcs.	1 pcs.	1 pcs.	5.3012.0201.1000.00
Driver 20W 250-700mA max. 55V DALI	9 pcs.	4 pcs.	3 pcs.	1 pcs.	1 pcs.	-	-	5.3015.0301.2000.00
Driver 45W 500-1400mA max. 50V DALI	12 pcs.	6 pcs.	4 pcs.	2 pcs.	1 pcs.	1 pcs.	1 pcs.	5.3016.0401.2000.00

Elite Accessories

Type	Dimensions	Code
Driver cover	4.72" x 1.77"	5.3020.0100.0000.40

⚠ Driver cover recommended for ELITE 1, 2 and 3 (service revision).

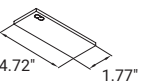

Elite 1 T



1.42"

Elite 2 T



2.68"

Elite 3 T



3.94"

Elite 5 T

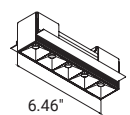

6.46"

Elite 8 T

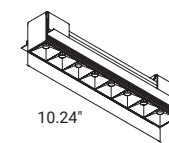

10.24"

Elite 10 T

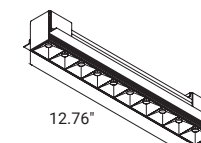

12.76"

Elite 12 T

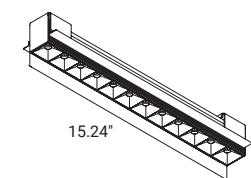

15.24"

LED color	g	Beam angle	i
830	2	30°	M
840	3	60°	W



Organic
LIGHTING

designplan® 